

All information in this Owner's Manual is current at the time of publication. However JAC reserves the right to make changes at any time so that our police of continual product improvement may be carried out.

This manual applies to all current JAC models and includes description and explanation of option as well as standard equipment. As a result, you may find material in this manual that does not apply to your specific vehicle.

Preface

Thank you for choosing JAC. We are pleased to welcome you to the growing number of discriminating people who drive JAC. The advanced engineering and high-quality construction of each JAC we build is something of which we are proud.

This Owner's Manual will introduce you to the features and operation of your new vehicle. It is suggested that you read it carefully since the information it contains can contribute greatly to the satisfaction you receive from your new vehicle.

The manufacturer also recommends that all service and maintenance on your vehicle be performed by an authorized JAC dealer. JAC dealers are prepared to provide high-quality service, maintenance and any other assistance that may be required.

Note: Because future owners will also need the information included in this manual, when you sell this vehicle, please leave it in the vehicle for their use. Thank you.

The manual has been edited on the basis of the truck air over hydraulic brake, left-hand drive vehicle. On the other models, only the differences have been covered. Some illustrations may not coincide with your vehicle, but the contents of explanations are common. The material in this publication may not be reproduced in any form without written permission from the JAC Motor Company.

ANHUI JIANGHUAI AUTOMOBILE CO., LTD.
JUN. 2008

SAFETY AND VEHICLE DAMAGE WARNING

This manual includes information titled as WARNING, CAUTION and NOTE.
These titles indicate the following:

WARNING:

This indicates that a condition may result in harm or injury to you or other persons if the warning is not heeded. Follow the advice provided with the warning.

CAUTION:

This indicates that a condition may result in damage to your vehicle or its equipment if the caution is not heeded. Follow the advice provided with the caution.

NOTE:

This indicates that interesting or helpful information is being provided.

Contents

	Page
BEFORE DRIVING	1
INSTRUMENTS & CONTROLS	16
STARTING & OPERATING	74
IN CASE OF EMERGENCY	113
APPEARANCE CARE	131
VEHICLE MAINTENANCE REQUIREMENTS	137
DUMP TRUCK	183
VEHICLE SPECIFICATION	229

BEFORE DRIVING

1. IMPORTANT INFORMATION

The followings are very important for the correct management and economic use of JAC vehicles, and they shall be read carefully before use and maintenance.

Manufacturer: Anhui Jianghuai Automobile co., Ltd	
MODEL:	<input type="text"/>
CHASSIS NO:	<input type="text"/>
ENGINE NO:	<input type="text"/>
VIN:	<input type="text"/>

Nameplate

The nameplate is located near the VIN, on which it marked with information about the vehicle, such as its vehicle model, engine model, ex-works date, etc.

Chassis number

The chassis number, that is VIN code number, is stamped on the outer side of the right longeron end of the frame.

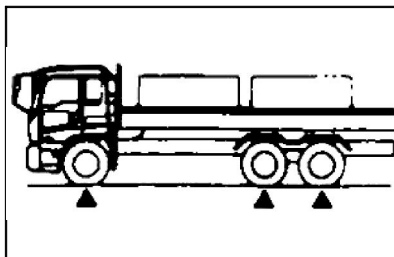

Overload

Overloading will shorten vehicle's service life, but also bring about potential risk to safe driving.

The loading mass must be limited to the specified range of the max. total mass for vehicle, and the load distributions on the front and rear shafts shall not be more than the carrying capacity of the vehicle shafts. Please refer to the technical specification sheet for the rated total mass value and shaft loading capacity.

2. BEFORE DRIVING YOUR JAC

BREAKING IN YOUR VEHICLE

Operate the vehicle at moderate speeds during the first 1,000 km (600 miles) to break it in. Make certain that the following points in particular are strictly observed.

- Allow the engine to warm up fully until the coolant temperature reaches about 60°C(140°F).
- Avoid racing the engine, abrupt start, acceleration and braking.
- Avoid overloading the vehicle, as this will result in a shorter life.
- Avoid high speed operation as far as possible. During break-in operation, make sure that the engine speed does not exceed 1,500 rpm.

Make sure that your vehicle does not miss the first 1,000 km(600 miles) and 5,000 km (2,500 miles) inspections.

After the first 1,000 km (600 miles) and 5,000 km(2,500 miles) or driving, take your vehicle to your nearest service shop for inspections based on the 'Maintenance Requirements'.

NOTE: Must have the engine of your vehicle checked at the authorized JAC service station. If you do not follow the precaution it may cause a series damage to the engine and is not covered by JAC.

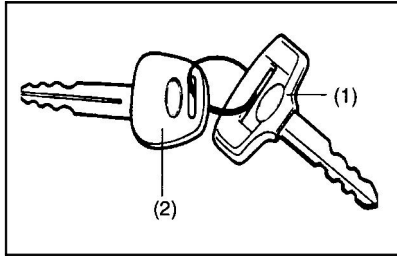

Keys

For greater convenience, your JAC has two types of keys. The master keys (1) will function in the ignition, locking or unlocking the door and fuel tank cap from outside. The electric tilting cap keys (2) will be used for locking or unlocking the electric tilting cap system (If installed). Carrying a spare key is recommended in case you accidentally lock one key inside the car.

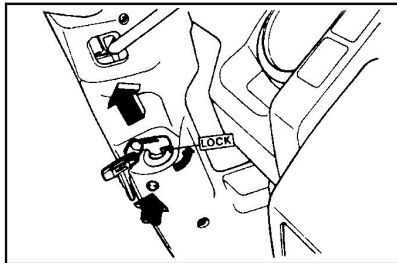

KEY LOCKS

You can release the key by pressing the knob when the key is in "LOCK" position.

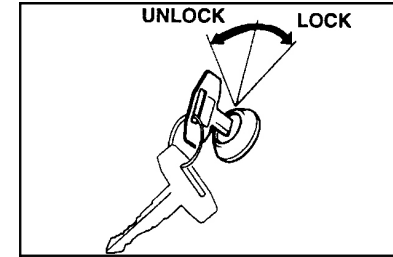

DOOR LOCKS

1. Locking using the key

Lock the door by turning the key toward the rear of the car and unlock it by turning it toward the front.

CAUTION:

Be careful not to lock the door with the ignition key left in the vehicle.

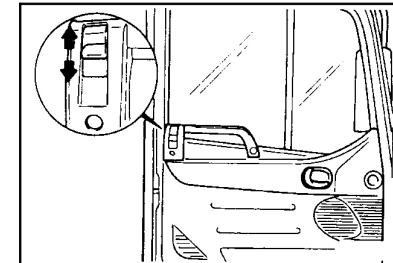

2. Locking from inside

To lock your JAC from inside, simply close the door and push the lock button down.

When this is done, the door cannot be opened using either the inside or the outside door handle.

NOTE:

When the door is open or ajar, the warning lamp door will light on.

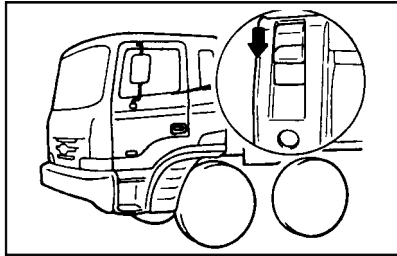

3. Locking from outside

The doors can be locked without a key.

First push the lock knob down, then close the door while depressing the push button forward.

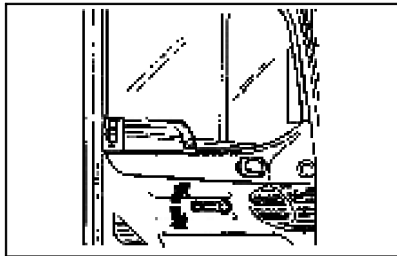

WINDOW GLASS

To raise or lower the window, turn the window, regulator handle clockwise or counterclockwise.

WARNING:

When opening or closing the windows, make sure your passenger's arms and hands are safely out of the way.

CENTRAL DOOR LOCKS (If installed)

The central door locking system is located on the driver's door lock button. It is operated by depressing the door lock button. If the front door is open when the button is depressed, the door will lock when closed.

NOTE:

When the front door lock button is depressed, the front doors will lock. When the front door lock button is pulled up, the front doors will unlock.

POWER WINDOWS (If installed)

The power windows operate when the ignition key is in the 'ON' position. The main switches are located on the driver's door side and control the passenger's side. The windows may be opened by depressing the appropriate window switch and closed by pulling upon the switch. To open the window on the driver's side, press the switch (1) halfway down. The windows move as long as the switch is operated. To fully open the driver's window automatically, press the switch fully down. In automatic operation, the window will fully open even if you let go of the switch. To stop at the desired opening, pull upon and release the switch. In order to prevent operation of the window by passenger, a window lock switch (2) is provided on the driver's door. There are two types of the power window switch. One operates for 30 seconds after the ignition key is turned to 'ACC' or 'LOCK', but the power window glass doesn't move when doors open.

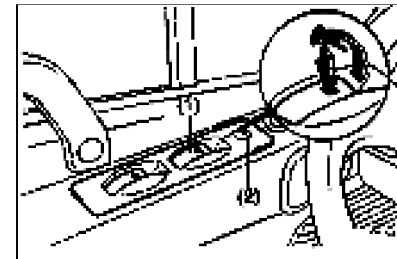

The other doesn't operate after the ignition key is turned to 'ACC' or 'LOCK

WARNING:

- Be careful that someone's head, hands and body are not trapped by closing window.
- Never try to operate the main switch on the driver's door and the passenger's door window switch in opposing directions at the same time. If this done, the window will stop and cannot be opened or closed.
- Do not leave children alone in the car. Always remove the ignition key for their safety.

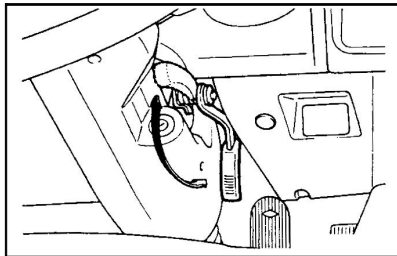

STEERING WHEEL TILT LEVER (If installed)

To adjust the steering wheel:

1. Pull the lever upward to unlock
2. Raise or lower the steering wheel to the desired position.
3. After adjustment, securely tighten the lever by pushing it downward.

WARNING:

Do not attempt to adjust the steering wheel while driving as this may result in loss of control of the vehicle and result in death or serious injury.

ADJUSTABLE SEAT

Never attempt to adjust the seat while the vehicle is moving. This could result in loss of control.

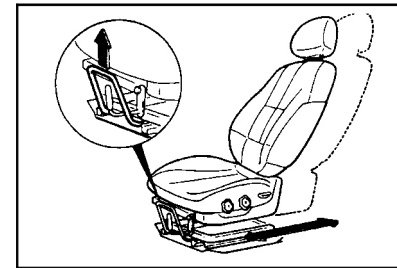

Adjusting Seat Forward and Rearward (If installed)(Driver's side only)

To move the seat toward the front or rear, pull the lock release lever upwards. This releases the seat on its track so you can move it forward or rearward to the desired position. When you find the position you want, release the lever and slide the seat forward or rearward on its track until it locks into position and cannot be moved further.

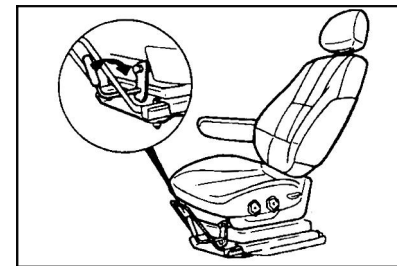

Seat Cushion Height Fixing (Driver's side only) (If installed)

To fix the height of the seat cushion, fit the locking knob to the locker. It will hold your seat position from the vibration.

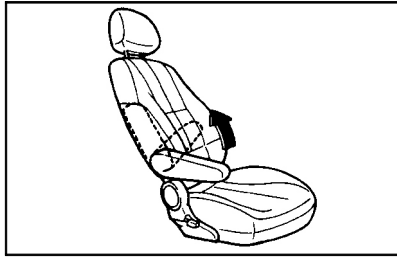

Adjusting Armrest Angle (Driver's side only) (If installed)

The armrest will be raised or lowered manually.

To raise the armrest, pull it up.

To lower it, press the armrest down.

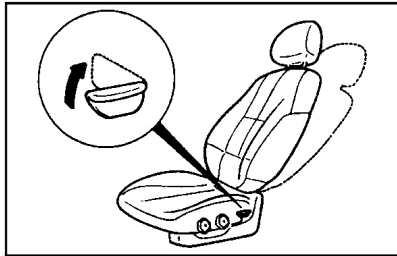

Adjusting Seatback Angle

To recline the seatback, lean forward to get your weight off it, then pull up on the recliner control lever at the outside edge of the seat. Now lean back until the desired seatback angle is achieved. To lock the seatback into position, release the recliner control lever.

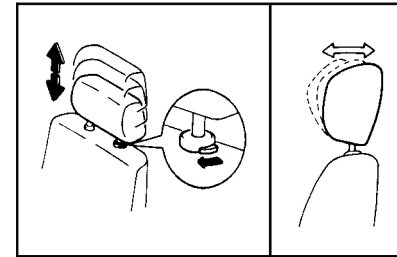

WARNING:

To minimize risk of personal injury in event of a collision or sudden stop, both the driver and passenger seatbacks should always be in a nearly upright position while the vehicle is in motion. The protection provided by the seat belts may be reduced significantly when the seatback is reclined. There is greater risk that the passenger will slide under the belt resulting in serious injury when the seatback is reclined.

Adjustable Headrests (If installed)

The headrests in your JAC may be raised or lowered by releasing the lock button on the headrest support. To raise the headrest, pull it up. To lower it, press the headrest down. To move the headrest forward, pull on the top. For maximum effectiveness in case of an accident the headrest should be adjusted so the top of the headrest is at the same height as the top of occupant's ears. For this reason, the use of a cushion that holds the body away from the seat back should not be used.

WARNING:

Do not operate vehicle with the headrests removed as injury to an occupant may occur in the event of an accident. Headrests may provide protection against neck injuries when properly adjusted.

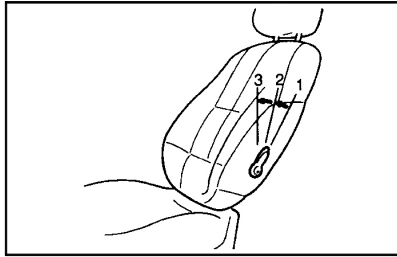

Lumbar Support Adjustment (If installed) (Driver's seat only)
The seats in some JAC are equipped with adjustable lumbar support. The lumbar support can be adjusted in three stages to provide the most comfortable support.
1. Weak; 2. Medium; 3.Strong

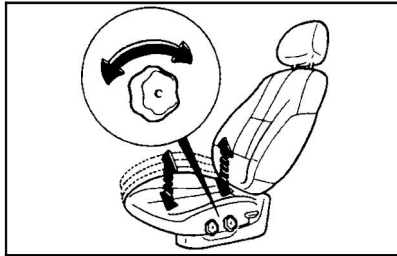

Seat Cushion Height Adjustment (If installed) (Driver's seat only)
To raise or lower the front part of the seat cushion, turn the front knob forward or rearward. To raise or lower the rear part of the seat cushion, turn the rear knob forward or rearward.

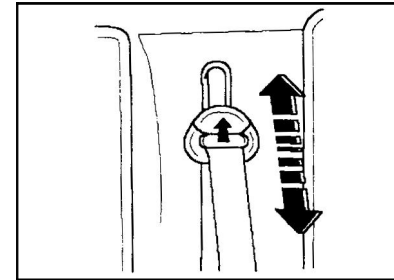

SEAT BELT PIVOT HEIGHT ADJUSTMENT (If installed)
The location of the upper anchorage point can be set (for greater belt comfort and security) to any one of four preset positions. To adjust the seat belt pivot push the knob upward or downward to the required setting, ensuring that it engages one of the preset positions (on releasing the knob).The height adjuster must always be locked into position while the vehicle is stationary. Do not attempt to adjust the height of the upper anchorage point while the vehicle is moving. If you are any doubt as to the method of adjustment or the optimum height position for your front seat belt always contact your nearest JAC Dealer.

WARNING:
The height adjuster must be in the locked position when the vehicle is moving.

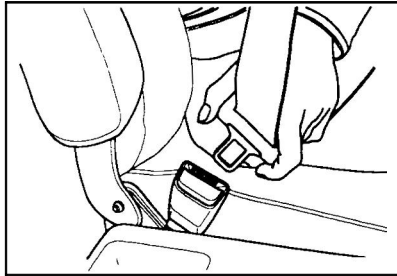

SEAT BELTS (3-Point Type)

To Fasten Your Belt

To fasten your seat belt, pull it out of the retractor and insert the metal tab into the buckle. There will be an audible "click," when the tab locks into the buckle. The seat belt automatically adjusts to the proper length only after the lap belt is adjusted manually so that it fits snugly around your hips. If you lean forward in a slow, easy motion, the belt will extend and let you move around. If there is a sudden stop or impact, however, the belt will lock into position. It will also lock if you try to lean forward too quickly.

Check to make sure the belt is properly locked and that the belt is not twisted.

NOTE:

If the driver's seat belt is not fastened when the ignition key is in the "ON" position, the seat belt warning light will flash.

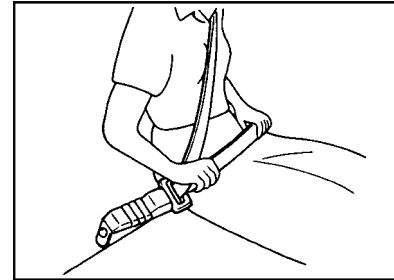

Adjusting Your Seat Belt

You should place the belt as low as possible on your hips, not on your waist. If located too high on your body, the chances of sliding out from under it and suffering serious injury or death are increased. Both arms should not be under or over the belt. Rather, one should be over and the other under, as shown in the illustration.

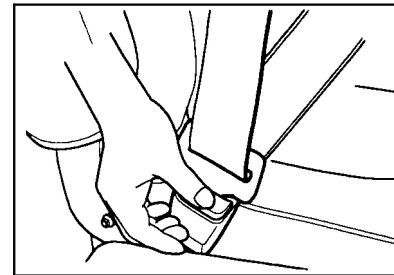

To Release the Seat Belt

The seat belt is released by pressing the release button in the locking buckle. When it is released, the belt should automatically draw back into the retractor. If this does not happen, check the belt to be sure it is not twisted, then try it again.

INSTRUMENTS & CONTROLS

INSTRUMENTS AND CONTROLS

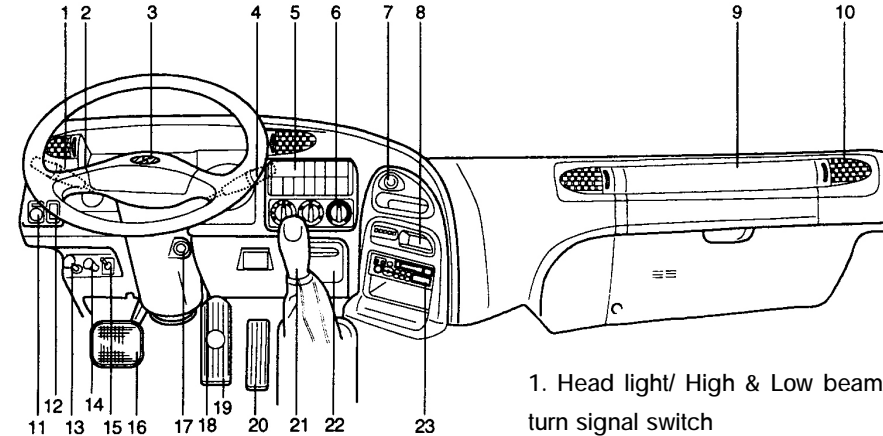

1. Head light/ High & Low beam/ turn signal switch
2. Control switches
3. Horn button
4. Wiper & washer/exhaust brake switch
5. Control switches
6. Air conditioner control switches

7. Cigarette lighter
8. Digital clock
9. Fuse box
10. Side ventilator louver
11. Horn convert switch
12. P.T.O switch
13. Parking brake
14. Engine RPM adjustable knob (E III not)
15. Work light switch
16. Clutch pedal
17. Start switch
18. Steering wheel adjusting lever
19. Brake pedal
20. Accelerator pedal
21. Shift lever
22. Ashtray
23. Audio system

Search light switch(only high cab)



Horn convert Switch
P.T.O switch

Search light switch(only high cab)

Press this switch, the search light will be light

Horn convert Switch

When the air pressure is above 6kpa,press the horn of the steering wheel, then the air horn will work

P.T.O switch

Press this switch , the P.T.O of special truck will work.

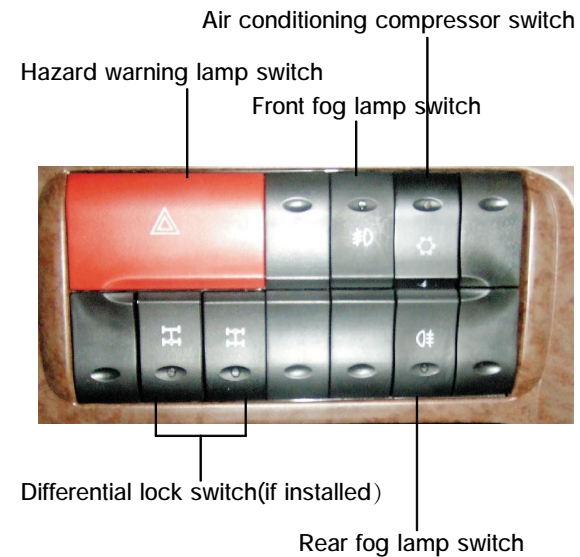

Fog lamp switch

Use the fog lamp when you go through the foggy area. Use the fog lamp rotating the multi-use lever to 1 step when you are not able to see well due to fog. While operating this switch, clearance lamp, tail lamp, licence plate lamp, instrument lamps will come on at the same time.

Depress the switch one more and the fog lamp will turn off.

Air compressor switch

When depress this switch, the air compressor of air condition will begin to work. Depress the switch one more and the fog lamp will stop.

Differential lock switch (if installed)

Depress the switch to lock the differential and check to see that the Differential lock indicator light is on. Depress the switch again to release the differential.

Lock the differential before driving on rough road. After getting out of the rough road, be sure to release the differential .If it has become impossible to move the vehicle and the differential is not locked, stop the rear wheels and lock the differential immediately.

INSTRUMENT CLUSTER AND INDICATOR(E II)

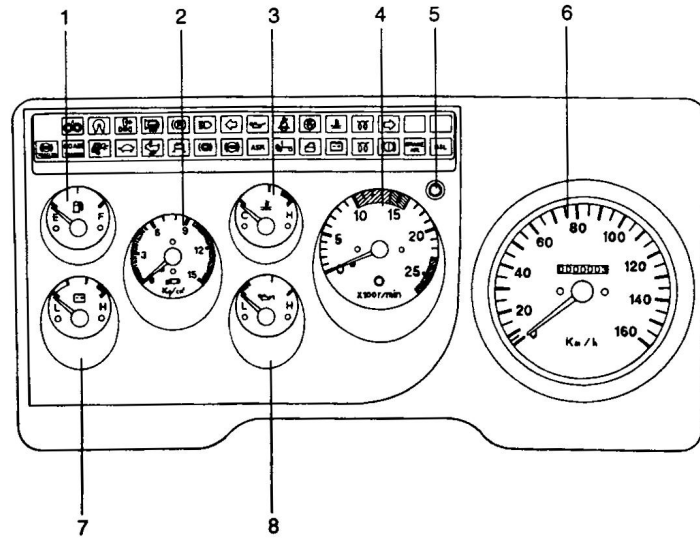

1. Fuel gauge
2. Air pressure gauge
3. Water temperature gauge
4. Tachometer
5. Indicator light inspection switch
6. Speedometer
7. Voltage gauge
8. Oil pressure gauge

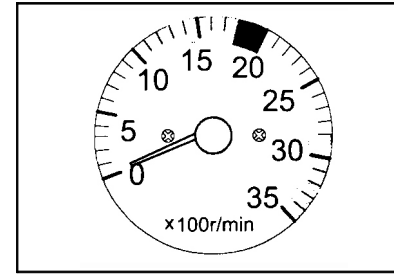

TACHOMETER

The tachometer registers the speed of your engine in revolutions per minute (rpm). It is useful to help you shift at the appropriate engine speed to avoid lugging or over running.

CAUTION:

The engine should not be raced to such a speed that the needle enters the red zone on the tachometer face. This can cause severe engine damage.

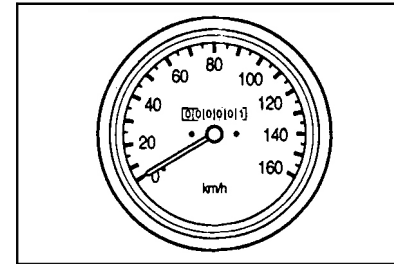

SPEEDOMETER

The speedometer indicates the vehicle speed in kilometers or miles per hour.

ODOMETER

The odometer records the total driving distance in kilometers or miles, and is useful for keeping a record for maintenance intervals.

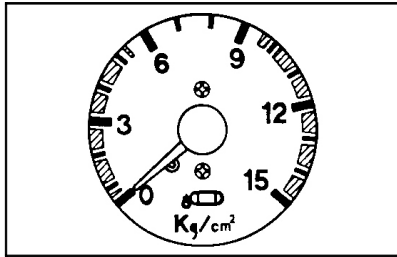

AIR PRESSURE GAUGE

The air pressure gauge indicates the air pressure in the air reservoir at all times.

If the air pressure drops to below 6 kg/cm², the air pilot light comes on and the warning buzzer will sound at the same time. If fails to build up again, stop the engine immediately and contact your authorized dealer.

CAUTION:

If the air pressure indicates the pressure that is below red zone do not drive the vehicle. This is very dangerous.

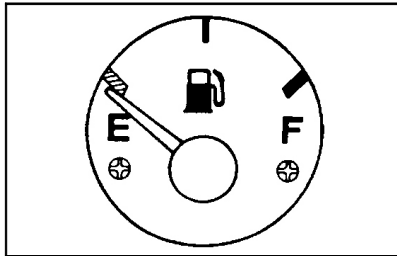

FUEL GAUGE

The fuel gauge will indicate the approximate fuel level in the tank, when the ignition is in the "ON" position.

The position of the pointer will vary slightly when accelerating, braking, or when the vehicle is going up or down hill. So check your fuel supply when the vehicle is more or less specified level, whether standing still or moving.

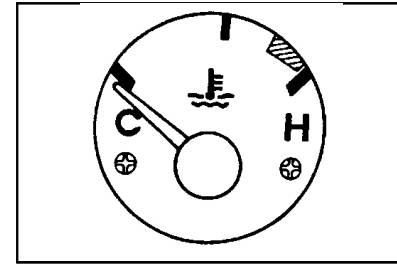

WATER TEMPERATURE GAUGE

When the ignition switch is "ON", this gauge indicates the temperature of the coolant. Under most driving conditions, the needle will remain at approximately the halfway point. Stop and go driving, driving at high speeds during warm weather or driving up a steep gradient may cause the pointer to move toward the red sector. If your vehicle overheats, water lamp comes and the indicator goes up. However when the quantity of coolant is below of the specification, the warning buzzer will sound.

At this time, stop your vehicle immediately.

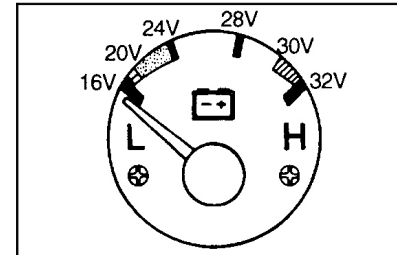

VOLTAGE GAUGE

The voltmeter indicates the battery state of charge. Check while the engine is running. The pointer should always indicate between 20 and 30 volts.

If the pointer reads above 30 volts or below 20 volts, contact your nearest authorized JAC dealer.

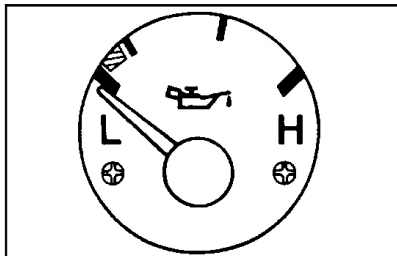

OIL PRESSURE GAUGE

The gauge indicates the engine oil pressure while the engine is running. If the gauge indicates below 0.5 kg/cm², oil warning lamp comes on and buzzer will sound at the same time.

At this time stop the engine immediately and check the lubricating system.

NOTE:

Engine oil pressure when the engine is cold may go up above normal pressure.

If the engine is warm, the gauge will indicate normal pressure immediately.

If the oil filter is clogged, the oil pressure warning light comes on but the buzzer will not sound.

INSTRUMENT CLUSTER AND INDICATOR(EIII)

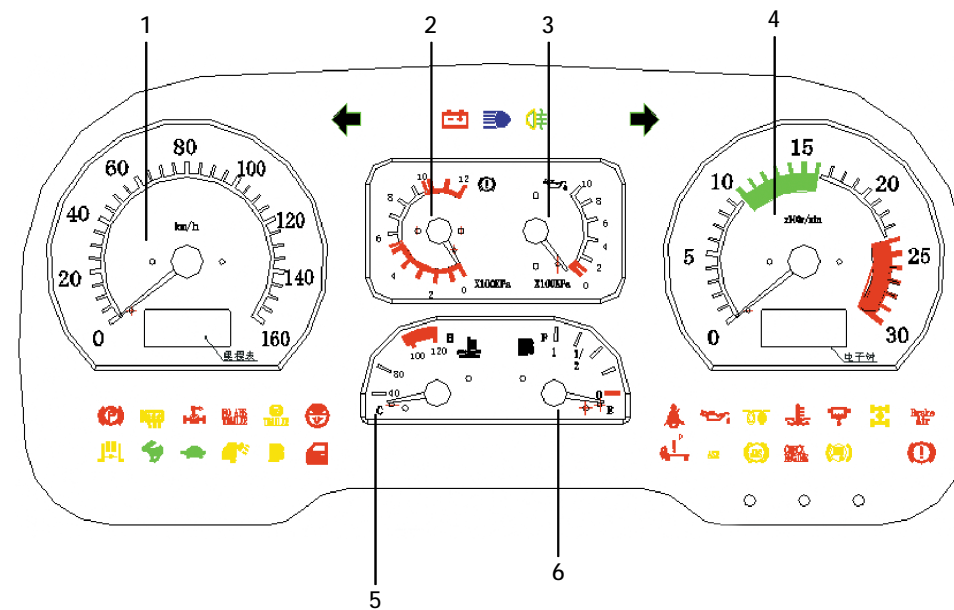

1. Speed/odometer
2. Air pressure gauge
3. Oil pressure gauge
4. Tachometer
5. Water temperature gauge
6. Fuel gauge

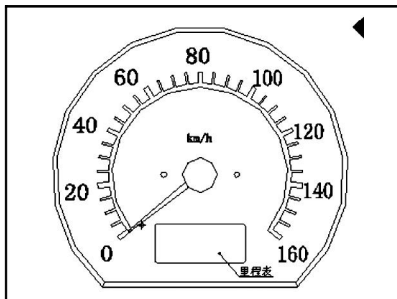

SPEED/ODOMETER

Speedometer

Speedometer mainly indicate the vehicle speed in kilometers or miles per hour.

Odometer

The odometer records the total driving distance in kilometers or miles, and is useful for keeping a record for maintenance intervals.

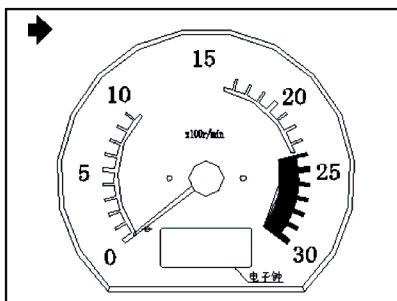

TACHOMETER

The tachometer registers the speed of your engine in revolutions per minute (rpm). It is useful to help you shift at the appropriate engine speed to avoid lugging or over running.

CAUTION:

The engine should not be raced to such a speed that the needle enters the red zone on the tachometer face. This can cause severe engine damage.

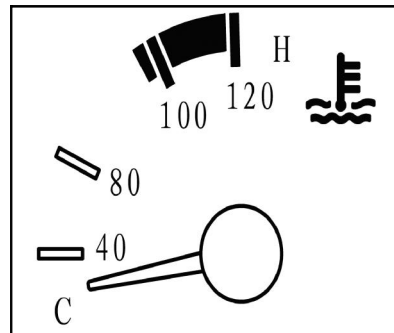

WATER TEMPERATURE GAUGE

When the ignition switch is "ON", this gauge indicates the temperature of the coolant. Under most driving conditions, the needle will remain at approximately the halfway point. Stop and go driving, driving at high speeds during warm weather or driving up a steep gradient may cause the pointer to move toward the red sector. If your vehicle overheats, water lamp comes and the indicator goes up. However when the quantity of coolant is below of the specification, the warning buzzer will sound.

At this time, stop your vehicle immediately.

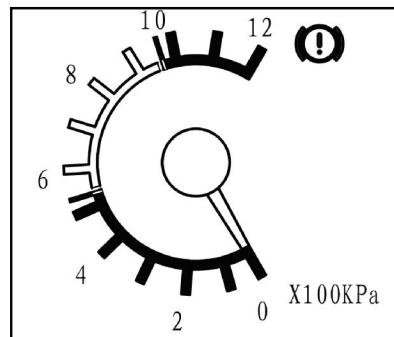

AIR PRESSURE GAUGE

The air pressure gauge indicates the air pressure in the air reservoir at all times.

If the air pressure drops to below 6 kg/cm², the air pilot light comes on and the warning buzzer will sound at the same time. If fails to build up again, stop the engine immediately and contact your authorized dealer.

CAUTION:

If the air pressure indicates the pressure that is below red zone do not drive the vehicle. This is very dangerous.

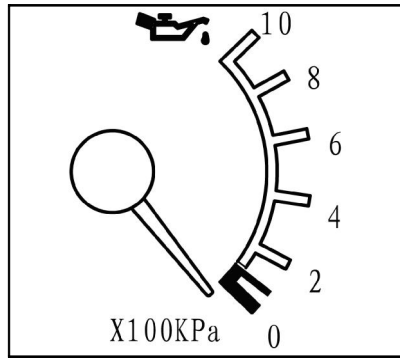

OIL PRESSURE GAUGE

The gauge indicates the engine oil pressure while the engine is running. If the gauge indicates below 0.5 kg/cm², oil warning lamp comes on and buzzer will sound at the same time.

At this time stop the engine immediately and check the lubricating system.

NOTE:

Engine oil pressure when the engine is cold may go up above normal pressure. If the engine is warm, the gauge will indicate normal pressure immediately. If the oil filter is clogged, the oil pressure warning light comes on but the buzzer will not sound.

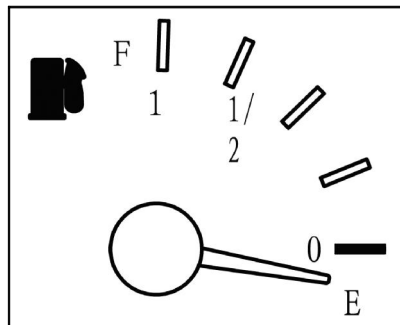

FUEL GAUGE

The fuel gauge will indicate the approximate fuel level in the tank, when the ignition is in the "ON" position.

The position of the pointer will vary slightly when accelerating, braking, or when the vehicle is going up or down hill. So check your fuel supply when the vehicle is more or less specified level, whether standing still or moving.

INDICATOR LIGHTS (E II)

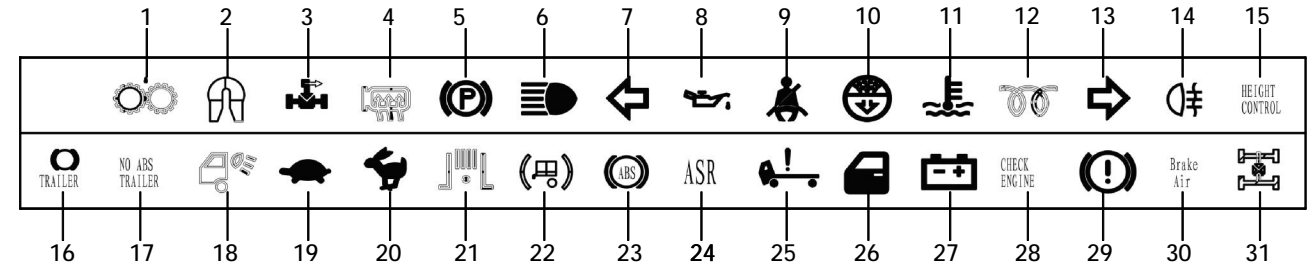

- | | | |
|--|--|---------------------------------------|
| 1. Auto Grease warning light | 11. Engine overheat warning light | 21. Exhaust brake warning light |
| 2. Trailer lock indicator light (only tractor) | 12. Air heater/relay light | 22. Trailer brake light |
| 3. P.T.O warning light | 13. Turn signal indicator light (right) | 23. ABS warning light |
| 4. Heater mirror indicator light | 14. Frog lamp switch indicator light | 24. Anti-slip regulator light |
| 5. Parking brake warning light | 15. High temperature control indicator light | 25. Cab tilting warning light |
| 6. High beam indicator light | 16. Trailer ABS indicator light | 26. Door ajar warning light |
| 7. Turn signal indicator light (left) | 17. NO ABS indicator light | 27. Charging system warning light |
| 8. Oil pressure warning light | 18. Working light indicator light | 28. Engine check warning light |
| 9. Seat belt warning light | 19. Low indicator light | 29. Air pressure warning light |
| 10. Filter indicator light | 20. Hi indicator light | 30. Brake warning light |
| | | 31. Differential lock indicator light |

INDICATOR LIGHTS (E III)

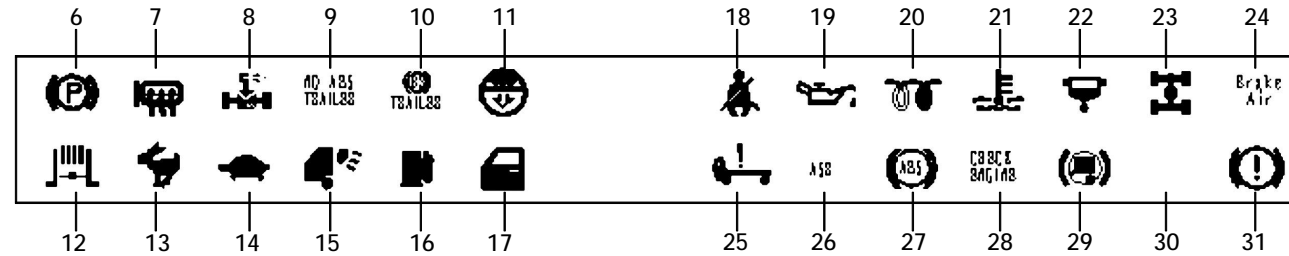
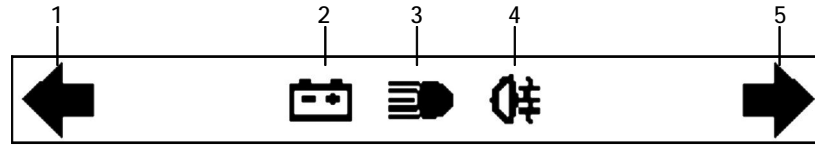

- | | | |
|--|--------------------------------------|--|
| 1. Turn signal indicator light (left) | 11. Filter indicator light | tor light |
| 2. Charging system warning light | 12. Exhaust brake warning light | 22. Oil and water separate indicator light |
| 3. High beam indicator light | 13. Hi indicator light | light |
| 4. Frog lamp switch indicator light | 14. Low indicator light | 23. Differential lock indicator light |
| 5. Turn signal indicator light (right) | 15. Working light indicator light | 24. Brake warning light |
| 6. Parking brake warning light | 16. Fuel alarm indicator light | 25. Cab tilting warning light |
| 7. Heater mirror indicator light | 17. Door ajar warning light | 26. Anti-slip regulator light |
| 8. Trailer lock indicator light (only tractor) | 18. Seat belt warning light | 27. ABS warning light |
| 9. NO ABS indicator light | 19. Oil pressure warning light | 28. Engine check warning light |
| 10. Trailer ABS indicator light | 20. Air heater/relay light | 29. Trailer brake light |
| | 21. High temperature control indica- | 30. Air pressure warning light |

 AUTO GREASE WARNING LIGHT

The auto grease warning light is on about 42 seconds when filling on grease at each moving part, then goes out.

This light comes on continuously when trouble occurs on this system.

 TRAILER LOCK LIGHT (ONLY TRACTOR)

The trailer lock light will be illuminated when transmission is shifted into reverse and trailer lock switch is on.

 P.T.O INDICATOR LIGHT

The P.T.O indicator light will be illuminated when the P.T.O switch is on.

CAUTION:

Be sure not to operate the switch while driving as this may cause damage to each power train parts.

 THE HEATER MIRROR INDICATOR LIGHT

When the heater mirror switch is on, the outside rearview mirror glass is heated and the heat mirror indicator light comes on at the same time.

 PARKING BRAKE

This light will be illuminated when the parking brake is applied and the ignition on, and should be extinguished when the parking brake is released. The vehicle should not be driven until the parking brake has been released and the light extinguished.

 HIGH BEAM INDICATOR LIGHT

The high beam indicator light comes on whenever the headlights are switched to high beam.

 TURN SIGNAL INDICATOR LIGHTS

The blinking green arrow on the instrument panel shows the direction indicated by the turn signals.

If the arrow comes on but does not blink, blinks more rapidly than normal or does not blink at all, a malfunction in the turn signal system is checked

 SEAT BELT REMINDER LIGHT

When the ignition switch is turned on, the seat belt warning light blinks for 5 seconds to remind the driver to wear their seat belt. If the driver fastens the seat belt within 5 seconds, the warning light goes out. When the ignition switch is turned to "ACC" or "LOCK" position, the warning light will also go out.

 OIL PRESSURE WARNING LAMP

This lamp illuminates when the ignition switch is set to the "ON" position and goes off after the engine has started. If it lights up while the engine is running, the engine must be stopped at once. Contact the nearest authorized JAC dealer.

 ENGINE OVERHEAT WARNING LIGHT

If the coolant temperature is too high this warning light will be on, if the coolant level is below than the designed quantity the buzzer will sound at the same time. At this time pull over and stop the vehicle as soon as possible and turn off the engine. Then check the coolant level. If necessary, add coolant. Same ratio as coolant in the radiator should be added.

 AIR HEATER/RELAY LIGHT

In severe cold season, if the light is on when turning the ignition key to the 'ON' position, hold it there until the light is off. At this time turn the ignition key to the "START" position.

 WORKING LIGHT INDICATOR LIGHT

When the working light switch is turned on the light comes on.

Turn the switch off after finishing the work or during driving normally.

 LOW LIGHT (ONLY TRACTOR, PULLCARGO, 8x4 VEHICLE)

The low light will be illuminated when it is in 'LOW' position in 2nd transmission.

 HIGH LIGHT (ONLY TRACTOR,PULL CARGO, 8x4 VEHICLE)

The high light will be illuminated when it is in 'HIGH' position in 2nd transmission.

 EXHAUST BRAKE WARNING LIGHT

The exhaust brake warning light will be illuminated if the exhaust brake switch is on. Put the exhaust brake switch back in its place where it was and this light goes out.

 RAILER BRAKE LIGHT (ONLYTRACTOR, PULL CARGO)

The trailer brake light comes on when the trailer brake switch is applied.

 ABS WARNING LIGHT

When the key is turned to 'ON', ABS warning light will be on and then off in a few seconds.

If ABS warning light remains on while driving, or remains off when the key is turned to "ON", there may be a problem about ABS.

In this case, you should show an authorized JAC dealer your vehicle and check it as soon as possible.

Though there is a problem about the vehicle, the normal brake system will still operate except ABS.

 ANTI-SLIP REGULATOR

When the key is turned to 'ON' position 'ASR' lamp will be illuminated.

If the brake is engaged, 'ASR' lamp goes out. But if it doesn't go out, "ASR" doesn't work.

When there is any problem about 'ASR' system , "ABS" lamp is illuminated.

During normal driving, 'ASR' lamp is off.

When 'ASR' works, 'AS R' lamp comes to blink.

NOTE:

"ASR" lamp is amber-colored and "ABS" lamp is red-colored. Amber means INDICATION and red means WARNING.

 CAB TILTING LIGHT

The cab tilting light will be illuminated when main hook didn't fix for cab locking.

 DOOR AJAR WARNING LIGHT

The door ajar warning light warns you that a door is not completely closed.

NOTE:

- Close the door completely.
- Before driving, check that the warning light has gone out.

 CHARGE WARNING LIGHT

The charge warning light should come on when the ignition key is turned on, then go out when the engine is running. If the light comes on while you are driving, stop and turn off the engine and check the tension of the belt. If the belt is loose or fraying, adjust or replace the belt.

 JAKE BRAKE OPERATION INDICATOR(If installed)

Jake brake is a kind of the engine brake. When it works, the lamp illuminates but, in case of the vehicle equipped with

the exhaust brake or retarder, it doesn't illuminate.

BRAKE WARNING LIGHT

The brake warning light will be illuminated when oil leaks from the brake system or the brake performance dropped due to wearing brake shoe.

If possible, stop immediately and contact your authorized dealer.

AIR PRESSURE WARNING LIGHT

When the air pressure in the air reservoir dropped (below 4.8-5.2 kg/cm²) and the engine is on the air pressure warning light comes on and the buzzer sounds at the same time. Then stop driving your vehicle immediately and run the engine at idle. Wait until the air pressure gets back and this warning light will go out.

CAUTION:

If the vehicle is driven in condition that air pressure warning light comes on, this is very dangerous. If a pressure rising time has a long interval, have the air system checked and repaired by an authorized dealer.

CHECK ENGINE WARNING LIGHT (If installed)

If the main key switch is turned on in normal condition, 'CHECK ENGINE' lamp will illuminate and then extinguish after two seconds. If it illuminates continuously, you can suspect any problem in it so have to check or repair in the authorized JAC dealer.

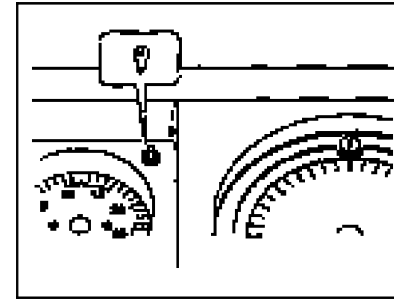

INDICATOR LIGHTS INSPECTION KNOB

To confirm a short of the bulb, press the knob.

In case of a short of the bulb, the bulb should be exchanged as soon as possible.

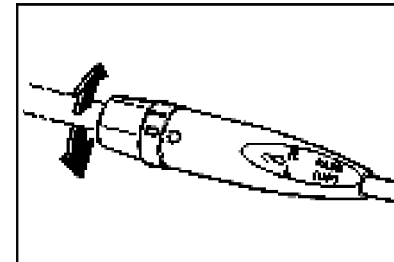

TURN SIGNAL SWITCH

Pulling the lever back (away from you) causes the turn signals the left side of the vehicle to blink. Pushing the lever forward (toward you) causes the turn signals on the right side of the vehicle to blink. As the turn is completed, the lever will automatically return to the center position and turn off the turn signals at the same time. If either turn signal indicator light blinks more rapidly than usual, goes on but does not blink, or does not go on at all, there is a malfunction in the system. Check for a burned-out fuse or bulb or you're your authorized JAC dealer.

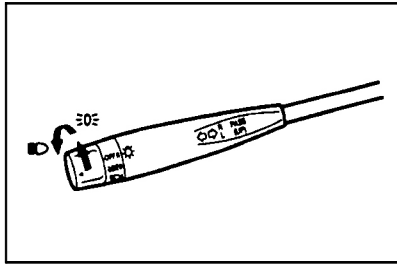

HEADLIGHT SWITCH

To operate the headlights, turn the barrel on the end of the multifunction switch. The first position turns on the parking lights, sidelights, taillights and instrument panel lights. The second position turns on the headlights.

High-beam and Low-beam

To turn on the headlight high beams, push the lever upward. For low beams, pull the lever down. The appropriate headlight beam indicator light will come on at the same time.

NOTE:

This function is operated when the headlight switch is in the "ON" position.

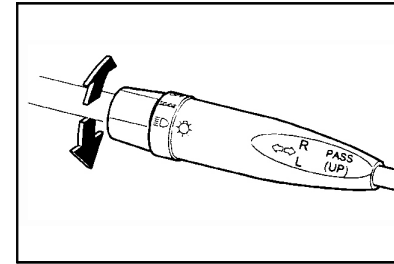

PASSING SWITCH

The headlights will be flashed when the lever is pushed upward and release automatically. The headlights can be flashed even though the headlight switch is in the "OFF" position.

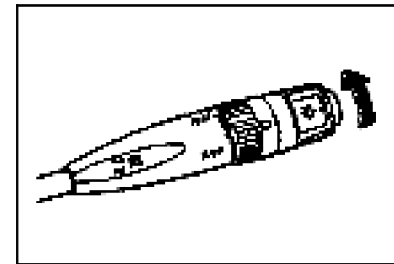

WINDSHIELD WIPER

The windshield wiper switch has three positions:

INT: Intermittent wiper operation

LO : Low-speed operation

HI : High-speed operation

NOTE:

To prevent damage to the wiper system, do not attempt to wipe away heavy accumulations of snow or ice.

Accumulated snow and ice should be removed manually, If there is only a light layer of snow or ice, operate the heater in the defrost mode to melt the snow or ice before using the wiper.

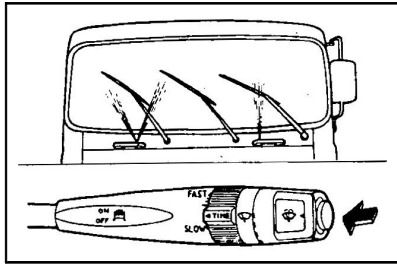

WINDSHIELD WASHER OPERATION

To use the windshield washer, press in on the button on the end of the wiper/washer lever. When the washer button is pressed, the wipers automatically make two passes across the windshield, And the windshield wiper is operated 2 to 3 times at the same time, The washer continues to operate as long as the button is depressed.

CAUTION:

- Do not use the wiper when the windshield is dry.
- The washer button should not be pressed if the washer reservoir is empty. This can damage the washer fluid pump. Do not operate the washer for more than 15 seconds at a time.

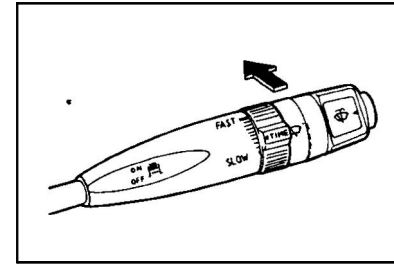

EXHAUST BRAKE SWITCH

To use the exhaust brake, put the "ON" position. The exhaust brake operates when you remove your foot from the accelerator pedal and the clutch pedal. The exhaust brake will not operate automatically if you operate the accelerator pedal or the clutch pedal.

Use exhaust brake when going down a slope.

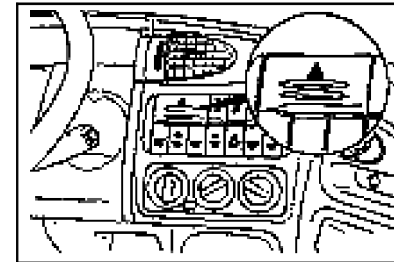

HAZARD WARNING

The hazard warning lamp should be used whenever you find it necessary to stop the car in a hazardous location. When you must make such an emergency stop, always pull off the road as far as possible.

The hazard warning lights are turned on by pushing in on the hazard switch. This causes all turn signal lights to blink. The hazard warning lights will operate even though the key is not in the ignition.

To turn the hazard warning lights off, push in on the switch a second time.

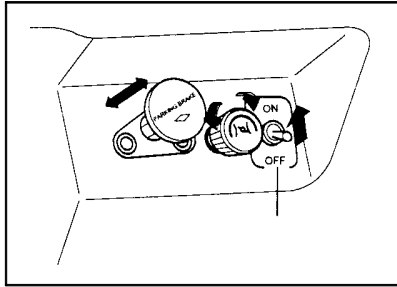

WORKING LIGHT SWITCH

There is a terminal for the work switch in the right side of the battery box.
When the switch is turned to "ON", you can use a light by connecting a terminal of the light to the terminal of the work switch.
(If you want to use a light, you should prepare the light and its terminal)

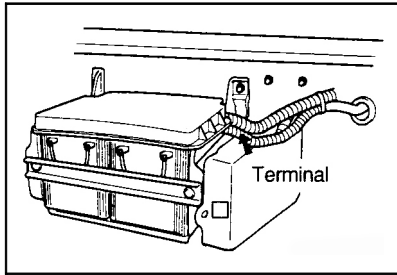

ELECTRIC TYPE(If installed)

The outside rearview mirror can be adjusted in any direction to give the maximum rear view vision.

The remote control outside rearview mirror switch controls the adjustments for both right and left door mirror.

To adjust the position of either mirror:

1. Move the selecting switch to the right or left to activate the adjustable mechanism for the corresponding door mirror.
Now, adjust mirror angle by depressing the appropriate perimeter switch as illustrated.

CAUTION:

- Do not operate the switch continuously for an unnecessary length of time.
- Scraping ice from the mirror face could cause permanent damage. To remove any ice, use sponge, soft cloth or approved de-icer.

WARNING:

Be careful when judging the size or distance of any object seen in the passenger side rear view mirror. It is convex mirror with a curved surface. Any objects seen in this mirror are closer than they appear.

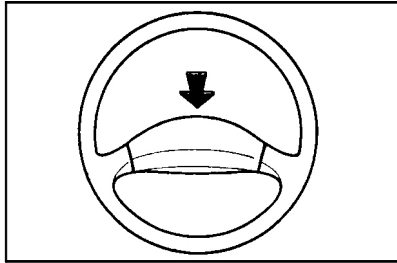

STEERING WHEEL & HORN

Your JAC is equipped with integral styled steering wheel. The horn button is located on the center of the wheel.

The horn sounds when the horn button is pressed firmly.

STARTING THE ENGINE IN WINTER

In cold winter when the ignition switch is turned to the ON position then the amber lamp  will come on. Hold the switch there and wait until the lamp is off. Start the engine.

AIR HEATING SYSTEM

The air heating system warms the intake air up in order to start the engine well and decrease white fume is emitted through the exhaust pipe in winter.

When the ignition key is turned to the ON position, the system is operated automatically.

If the  lamp is turned on when turning the ignition key to the ON position, wait until the lamp is off. And start the engine.

CAUTION:

If the  lamp blinks, the air heating relay may be damaged or a fuse blown, Check and replace it.

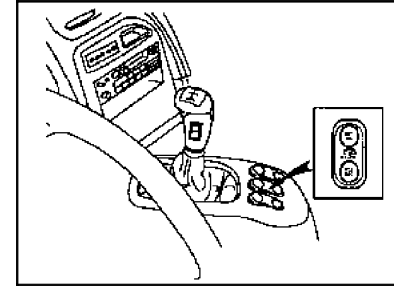

POWER MIRRORS SWITCH

To fold the outside rearview mirrors, push them toward the rear.

The outside rearview mirrors can be folded rearward for parking in narrow areas.

WARNING:

Do not adjust or fold the outside rearview mirrors while the vehicle is moving. This could result in loss of control, and an accident which could cause death, serious injury or property damage

PARKING BRAKE(EXCEPT TRACTOR, PULL CARGO)

Always engage the parking brake before leaving the vehicle. This also turns on the parking brake indicator light when the key is in the "ACC" or "ON" position. Before driving away, be sure that the parking brake is fully released and that the indicator light is off.

- To engage the parking brake, pull the lever up.
- To release the parking brake, pull up and press thumb button.

NOTE:

The buzzer may sound when the parking brake is released. (ONLY TRACTOR, PULL CARGO) If the buzzer sounds, have the brake system checked as follows:

- Check the air pressure in the air reservoir.
- Check the oil leaks from brake system.
- Check the clearance of brake shoes.

FULL AIR BRAKES

The full air brake vehicles are equipped with an emergency brake. Should the compressed air pressure fall below 2.7 kgf/cm² (265kPa), spring operated emergency brake is automatically applied to the rear wheels. On tractors, service brakes are applied to the trailer as well.

INTERIOR LIGHT

The interior courtesy lights has two buttons.

The two buttons are:

In the "☑" position, the interior courtesy light comes on when any door is opened regardless of the ignition key position.

In the "ON" position, the light stays on at all times.

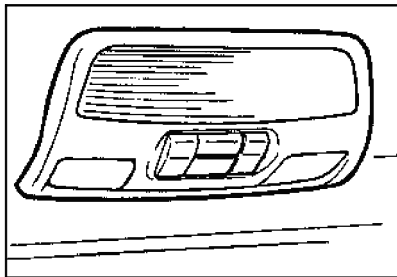

Map Light

The two map lamp switches are located on both sides of the interior light. Push in the map light switch to turn the light on or off.

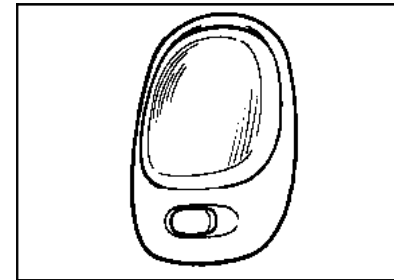

Reading Light

The reading light has a button of three positions.

The three positions are:

- DR (●)

In the middle position (●), the interior courtesy light comes on when any door is opened regardless of the ignition key position. The light goes out when the door is closed.

- ON

In the 'ON' position, the light stays on at all times.

- OFF

In the 'OFF' position, the light stays off at all times even though a door is open.

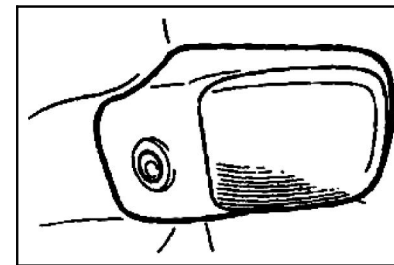

Fluorescent light

The fluorescent light is located on the front overhead console. Push in the fluorescent light to turn the light on or off.

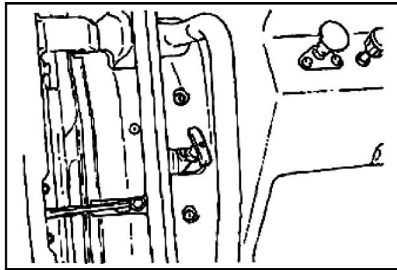
**HOOD RELEASE**

Pull the release knob to open the hood. The hood will spring up slightly. In front of the vehicle, lift the hood. The hood will open completely by itself after it raised about halfway. To close the hood, lower and press down on it. After closing the hood, try pulling it up to make sure it is securely closed.

CAUTION:

The hood should be kept closed when the car is in motion.

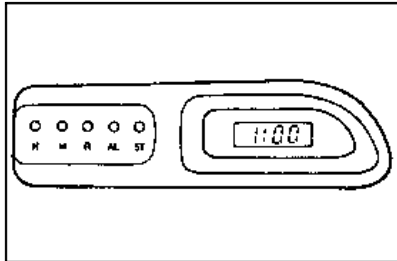
**DIGITAL CLOCK**

There are five control buttons for the digital clock. Their functions are:

HOUR - Push "H" to advance the hour indicated.

MIN - Push "M" to advance the minute indicated.

RESET - Push 'R' to reset minutes to ':00' to facilitate resetting the clock to the correct time. When this is done:

Pressing 'R' between 10:30 and 11:29 changes the readout to 11:00. Pressing

'R' between 11:30 and 12:29 changes the readout to 12:00.

ALARM - In state of holding the alarm button, push 'H' or "M".

STOP - To stop the alarm, push the "ST" button.

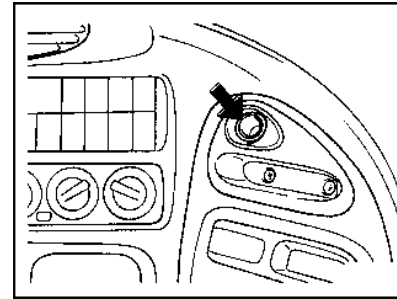
**CIGARETTE LIGHTER**

For the cigarette lighter to work, the key must be in the "ACC" position or the "ON" position.

To use the cigarette lighter, push it all the way into its socket. When the element has heated, the lighter will pop out to the "ready" position.

Do not hold the cigarette lighter pressed in. This can damage the heating element and create a fire hazard.

If it is necessary to replace the cigarette lighter, use only a genuine JAC replacement or its approved equivalent.

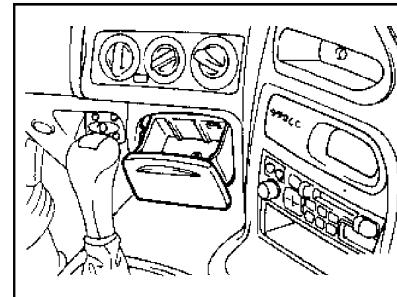
**ASHTRAY**

The ashtray may be opened by pushing and releasing the ashtray door at its top edge.

To remove the ashtray in order to clean it, the metal ash receptacle should be removed from the ashtray door. Do not attempt to remove the entire ashtray door assembly or damage will result. Instead, push the metal ash receptacle down and forward in the ashtray door, and it can then be lifted out. To reinstall it, place it in the proper position and press it down and forward to re-engage the ash receptacle rear lip in the ashtray door. The ashtray lamp will only illuminate when the exterior body lights are switched on.

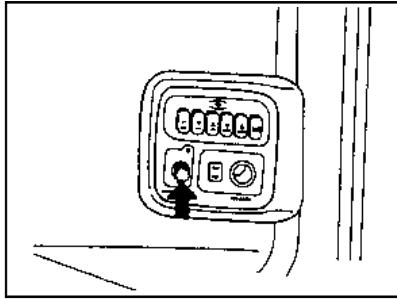

BED TEMPERATURE ADJUSTABLE KNOB (If installed)

If the knob is turned clockwise the bed temperature increases, and if it is counterclockwise, the temperature decreases

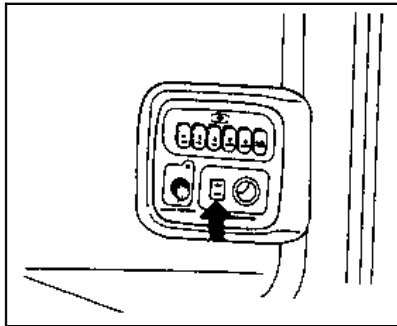

POWER OUTLET (If installed)

This supplies 12V electric power by converting 24V of the battery into 12V and it makes be able to operate various accessories or equipment for 12V.

CAUTION:

Be careful to use the outlet under the lower panel of the passenger's side because it supplies 24V

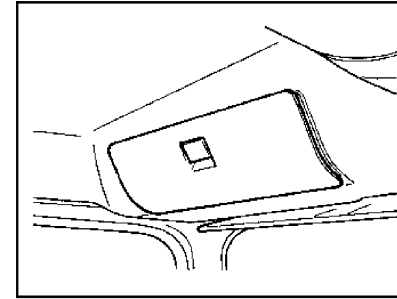

OVERHEAD CONSOLE

The overhead console is located in the interior ceiling.

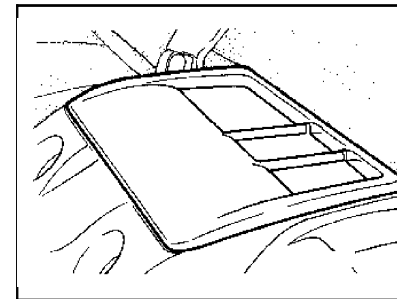

FLOOR CONSOLE

The floor console is located between driver's and passenger's seat for additional storage.

NOTE:

Keep it in the closed position while driving.

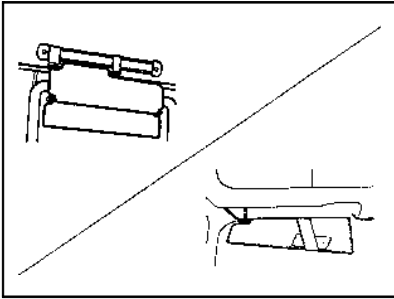
**SUNVISOR**

Your JAC is equipped with two sunvisors to give the driver and passenger either frontal or side ward shade. The sunvisors are fitted on both sides on standard models. To reduce glare or to shut out direct rays of the sun, turn the sunvisor down to block the annoyance.

Some vehicles are equipped with the front and side sunvisors for the driver, and the front sunvisor for the passenger.

CAUTION:

Do not place the sunvisor in such a manner that it obscures visibility or the roadway, traffic or other objects.

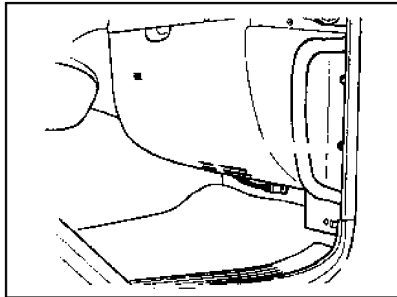
**AIR SPRAY NOZZLE**

Separate the spray nozzle plug under the dash panel of passenger side and connect the air hose with this plug. Then you can clear your vehicle with air spray.

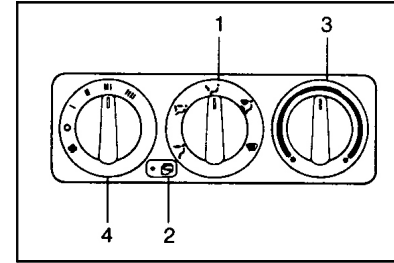
**HEATING AND VENTILATION****Rotary Type (If installed)**

There are four controls for the heating and cooling system. They are:

1. Air Flow Control.

This is used to direct the flow of air. Air can be directed to the floor, dashboard outlets, or windshield. Five symbols are used to represent Face, Bi-Level, Floor, Floor-Defrost and Defrost air positions.

2. Air Intake Control.

This allows you to select fresh outside air or to circulate inside air.

3. Temperature Control.

This is used to select the degree of heating desired.

4. Fan Speed Control.

This is used to turn the fan on and select the fan speed.

AIR FLOW CONTROL

This is used to direct the flow (of air. Air can be directed to the floor, dashboard outlets, or windshield. Five symbols are used to represent Face,Bi-Level, Floor, Floor-Defrost and Defrost air position.

 Face-Level

Selecting the "Face" mode will cause air to be discharged through the face level vents.

 Bi-Level

Air is discharged through the face vents and the floor vents.

 Floor-Level

Air is discharged through the floor vents.

 Floor-Defrost Level

Air is discharged through the windshield defrost vents and the floor vents.

 Defrost-Level

Air is discharged through the windshield defrost vents.

AIR INTAKE CONTROL

This is used to select fresh outside air or recirculation inside air.

 Fresh

 Recirculation

To change air intake control mode, (Fresh mode Recirculation mode) push the control button.

FRESH MODE (): The indicator lamp on the button goes out when the air intake control is fresh mode.

RECIRCULATION MODE (): The indicator lamp on the button is illuminated when the air intake control is recirculation mode.

With the "fresh" mode selected, air enters the vehicle from outside and is heated or cooled according to the other functions selected.

With the "fresh" mode selected, air from within the passenger compartment is drawn through the heating system and heated or cooled according to the other functions selected.

NOTE:

It should be noted that prolonged operation of the heating system in "recirc" mode will give rise to misting of the windshield and side windows and the air within the passenger compartment becoming stale. In addition prolonged use of the air conditioning with the "Recirculate" mode selected may result in the air within the passenger compartment becoming excessively dry.

FAN SPEED CONTROL(BLOWER CONTROL)

This is used to turn the blower fan on and off and to select the fan speed.

The blower fan speed, and the volume of air delivered from the system, may be controlled manually by setting the blower control between the "1" and "4" position.

Heating controls

1. For normal heating operation, set the air intake control to the "Fresh" position and the air flow control to 'Floor'.
2. For faster heating, the air intake control should be in the 'Recirculation' position.
3. If the windows fog up, set the air flow control to the 'Def' (defroster) position and the air intake control to "Fresh".
4. For maximum heat, move the temperature control to "Warm".

BI-LEVEL HEATING

Your JAC is equipped with bi-level heating controls. This makes it possible to have cooler air from the dashboard vents and warmer air from the floor outlets at the same time. To use this feature:

1. Set the air flow control at the "Bi-Level" position.
2. Set the temperature control between "Cool" and "Warm".
3. Adjust the fan speed control to the desired speed.

VENTILATION

To operate the ventilation system:

1. To direct all intake air to the dashboard vents, set the airflow control to "Face".
2. Set the temperature control between "Cool" and "Warm".
3. Adjust the fan speed control to the desired speed.

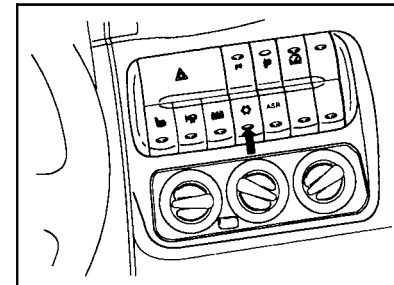
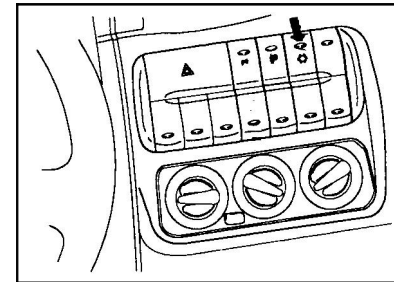
**AIR CONDITIONING (If installed)****Air Conditioning Switch**

The air conditioning is turned on by pushing the button.

AIR CONDITIONING OPERATION**Cooling**

To use the air conditioning to cool interior:

- Turn on the fan control switch.
- Turn on the air conditioning switch by pushing in on the switch. The air conditioning indicator light should come on at the same time.
- Set the air intake control to "Recirculation".
- Set the temperature control to "Cool". ("Cool" provides maximum cooling. The temperature may be moderated by moving the control toward "Warm".)
- Adjust the fan control to the desired speed.

For greater cooling, turn the fan control to one of the higher speeds or temporarily select the "Recirc" position on the air intake control.

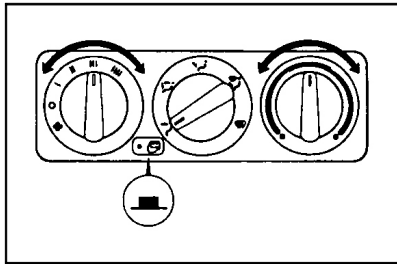

DE-HUMIDIFIED HEATING

For de-humidified heating:

- Turn on the fan control switch.
- Turn on the air conditioner switch. The air conditioner indicator light should come on at the same time.
- Set the air intake control to "Fresh".
- Set the air flow control to "Face".
- Adjust the fan control to the desired speed.
- For more rapid action, set the fan at one of the higher speeds.
- Adjust the temperature control to provide the desired amount of warmth.

Operation Tips

- If the interior of the car is hot when you first get in, open the windows for a few minutes to expel the hot air.
- When you are using the air conditioning system, keep all windows closed to keep hot air out.
- When moving slowly, as in heavy traffic, shift to a lower gear. This increases engine speed, which in turn increases the speed of the air conditioning compressor.

- On steep grades, turn the air conditioning off to avoid the possibility of the engine overheating.
- During winter months or in periods when the air conditioning is not used regularly, run the air conditioning once every month for a few minutes.
- This will help circulate the lubricants and keep your system in peak operating condition.

Turning off air conditioner

When air conditioner is not used, place the fan switch to OFF position. When the vehicle is parked, set the button to 'Recirculation mode' to prevent dust from entering the vehicle.

Others

Use of air conditioner for long hours with the button placed at 'Recirculation mode' will contaminate the air inside the vehicle. Place the button at "Fresh mode" once in a while.

Excessive cooling is not good for health. The cooling temperature best suit to your health is normally 5 to 6 degrees lower than the outside air temperature. (You will feel slightly cool when you enter the vehicle cooled at this temperature.)

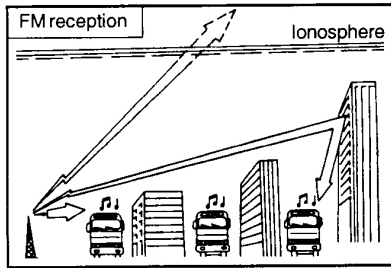

STEREO SOUND SYSTEM

How Car Audio Works

AM and FM radio signals are broadcast from transmitter towers located around your city. They are intercepted by the radio antenna on your car. This signal is then received by the radio and sent to your car speakers.

When a strong radio signal has reached your vehicle, the precise engineering of your audio system ensures high quality reproduction. However, in some cases the signal coming to your vehicle is not strong and clear. This can be due to factors such as the distance from the radio station, closeness of other strong radio stations or the presence of buildings, bridges or other large obstructions in the area.

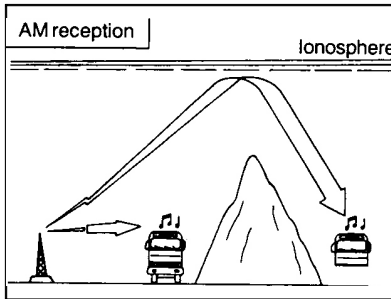

AM signal reception is usually better than FM reception. This is because AM radio waves are transmitted at low frequency. These long, low frequency radio waves can follow the curvature of the earth rather than travelling straight out into the ionosphere. In addition, they curve around obstructions so that they can provide better signal coverage. Because of this, clear AM broadcasts can be received at greater distances than FM broadcasts.

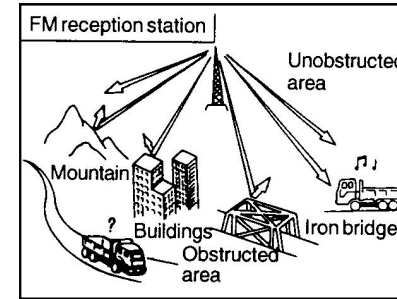

FM broadcasts are transmitted at high frequency and do not bend to follow the earth's surface. Because of this, FM broadcasts generally begin to fade at short distances from the station. Also, FM signals are easily affected by buildings, mountains, or other obstructions. These can result in certain listening conditions which might lead you to believe a problem exists with your radio. The following conditions are normal and do not indicate radio trouble:

- Fading - As your car moves away from the radio station, the signal will weaken and sound will begin to fade. When this occurs, we suggest that you select another stronger station.
- Flutter/Static - Weak FM signals or large obstructions between the transmitter and your radio can disturb the signal causing static or fluttering noises to occur. Reducing the treble level may lessen this effect until the disturbance clears.
- Station Swapping - As a FM signal weakens, another more powerful signal near the same frequency may begin to play. This is because your radio is designed to lock onto the clearest signal. If this occurs, select another station with a stronger signal.
- Multi-Path Cancellation - Radio signals being received from several directions can cause distortion or fluttering. This can be caused by a direct and a reflected signal from the same station, or by signals from two stations with close frequencies. If this occurs, select another station until the condition has passed.

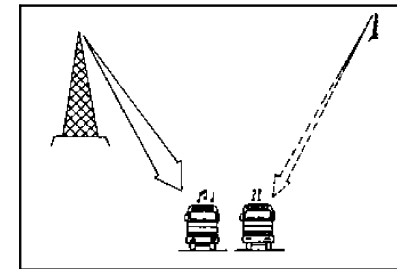

Radio



- | | | |
|-----------------------|-----------------------------------|--|
| 1. Tune select button | 6. FF/REW/(◀◀ and ▶▶)/Autoreverse | 11. Digital display window |
| 2. SELECT button | 7. MODE reverse | 12. Seek select button) |
| 3. POWER button | 8. Station remember | 13. Time display and adjust the time (CLOCK) |
| 4. Eject button(▲) | 9. Digital button (1, 2, 3) | 14. Digital button(4, 5, 6) |
| 5. Tape slot | 10. Band select | |

1. POWER ON/OFF BUTTON

The radio unit may be operated when the ignition key is in the "ACC" or "ON" position.

2. VOLUME CONTROL BUTTON

Depress the "+" button to increase the volume, and depress the "-" button to increase the volume.

3. BALANCE CONTROL

Press to pop the knob out and turn it clockwise or counterclockwise until sound from the left and right speakers is about equal from your listening position.

4. BASS/TREBLE CONTROL

Press to pop the knob out and turn to the left or right for the desired bass tone.

5. TUNE (Manual) SELECTION

When the upper side of the knob is pressed, the frequency will increase in 0.1 MHz steps in FM band, 9 KHZ in AM band and vice versa. With the button held down for 0.5 Sec. or more, the stop signal (broadcasting radio wave) is ignored, and channel selection continues.

6. CLOCK BUTTON

Depress the "CLOCK" button, the digital window will display the time.

Keep depressing the "CLOCK" button for three seconds, you can adjust the time.

Then you can adjust the time by "+" "-" button.

7. BAND SELECTOR

Pressing the BAND button changes the AM, FM bands. The mode selected is displayed on LCD.

8. SELECT STATION

(If you have knew the station)

▶ ◀ Station select

9. AUTO SELECT

At the audio playing condition, keep depressing AS/PS button for at least 2 seconds, then enter the automatic search mode. The station that have been searched will be memory .

10. PRESET STATION

Stations may be programmed into the memory of the radio. Then, by simply pressing the band select button and/or one of the six station select buttons, you may recall any of theae station instantly.

11. BAND SELECTOR

Press the BAND button changes the bands.

Tape playing

Playing

- Insert cassette with exposed tape side facing towards to cassette slot.
- Insertion of the cassette will automatically cut off the radio reception and playback will start.
- Depress ▲ button completely, the playing will be stopped and then enter the radio mode. At the same time, you can take back the tape. Press MODE button can return the radio playing.

Reverse

- Depress ◀◀ and ▶▶ button half at the same time, the tape will autoreverse.

- The tape will play reverse side of tape if one side of the tape is played over.

- ◀◀ fast forward

- ▶▶ fast backward

Note: You should clean the magnetized objects one or two times every one month after a long time using.

Please use high-quality cassette.

Proper care of you cassette tapes will extend the tape life and increase your listening enjoyment. Always protect your tapes and cassette cases from direct sunlight, serve cold and dusty conditions. When not in use, cassette should always be stored in the protective cassette case in which they were originally supplied.

Troubleshooting

If you find some of the functions of the acoustic apparatus in your vehicle do not work any more, you'd better do a careful reading of the instructions in the manual before having it repaired, and do a check against the list below. And this will be helpful to you in troubleshooting. If the trouble cannot be removed still, please send it to the maintenance station for repair. Do not dismantle and repair it by yourself.

CD





Panel function descriptions

- 1Preset key 1 RND*..... CD random play on/off
- 2Preset key 2 RPT*..... CD repeat on/off
- 3Preset key 3 SCN*... CD music scanning
- 4Preset key 4
- 5Preset key 5
- 6Preset key 6
7. SOUNDsound effect mode, sound effect key
8. Short press: power on; Long press: power off.
- 9.....Monitor
10. ...Volume knob. Press up/down to adjust the sound volume; regulate the frequency mode selected.
11. .. SOURCE.....Short press: select the sound source (CD).
BAND.....Short press: select the wave band
AST..... Long press: auto storage (CD)Short press: auto storage(cassette)
12.Attuning mode(short press: auto search upward / downward; long press: manual search upward/downward)
13. fast forward
14.fast backward
15.Eject key (CD)
16. Disc chamber/cassette chamber

Acoustic apparatus

on/off

- Press  for start, and press  over 2 seconds and the master unit is turned off.

Sound volume

Press - or + to adjust the volume.

Mute

Short press  key to enable/disable mute mode.

Sound effect mode

Select the desired type of sound effect as per your personal preference. Press SOUND key to select BASS-TRE, and press the sound volume key +/- to adjust the type of sound effect.

- -BAS-TRE : auto setting the BASS or TRE of the apparatus.
- -FLAT : Original
- -JASS : Jazz music
- -VOCAL : Speech
- -POP : pop music
- -CLSSIC : classical music
- -ROCK : rock & roll music

Acoustic mode setting

Press SOUND key to select the item you want to adjust.

- -Sound effect type: (BAS-TRE, FLAT, JASS, VOCAL, POP, CLSSIC, ROCK)
- -BASS: deep sounding
- -TREBLE: high pitch
- -BLANCE: balance on left and right
- -BLANCE: balance on left and right
- -BLANCE: balance on left and right
- Again press +/- key to adjust the item selected.

Five seconds later the screen turns back to the previous mode.

Only with BASS-TRE selected as the sound effect mode, can BASS and TRE settings be adjusted.

Sound source selection

Press SOURCE key to select the desired sound source.

- -Radio
- -CD/Cassette*

When a cassette is inserted in, the sound source will be automatically changed from radio to cassette play. Please take out cassette when you want to listen to radio, so as to protect the unit.

Radio

Wave band

Press the BAND key to select the wave band desired.



Auto search

Press Button ◀ or ▶ to auto search the radio stations.

Press ◀◀ or ▶▶ key to tune to the radio stations of low frequency, or press key ▶ to tune to the radio stations of high frequency.

You may press the same key if you want to search for another radio station.

Manual search (if you know the frequency of the radio station you need)

Long press Key ◀ or ▶ for about 2 seconds before entry of manual search. Press Key ◀ for search of low-frequency radio stations.

Press ▶ for search of high frequency radio stations (If there is no search in 5 seconds, the system will return to the previous operation state).

Preselected radio stations (stored or preselected)

Manual storage of radio stations in preset keys

Use the preset keys (1-6) to store 6 radio stations in each wave band.

Tune to the radio station desired, and press the preset key needed (1-6) for 2 seconds at least, and the radio station available now can be stored into this preset key.

Call back the presetting

Press the preset key needed (1-6), the preset radio station will be called out.

Auto storage of radio stations

This function can auto store 6 FM radio stations(with most powerful signals) in the FMAST wave band or 6 MW(AM) radio stations

(With most powerful signals) in the MW (AM) wave band. When this auto storage function is used for new radio stations, new radio stations will take the place of those stored previously in FMST or MW (AM)AST waveband.

Press AST key to activate the auto storage function.

The main unit gives out "beep" before muteness.

"Beep" can be heard after the storage is over.

Sometimes less than 6 radio stations can be found.

CD play *(CD)

Put the disc (printed side up)into the disc chamber and the play begins.

If a disc is already in the chamber, press the SOURCE key to select CD as the source. Play begins.

Previous/next music (◀ or ▶)

Press Key ◀ or ▶ to select the music desired. Play begins with the music selected.

Music fast forward/backward (◀ or ▶)

Press Key 3 ◀ or ▶ for more than 2 seconds to drive the disc fast forward or fast backward. Release the key and the normal play will go on.

Random play

Press RND key for at least 2 seconds to activate/quit Random play.

Repeated play

Repeat the play of the present music. Press RPT key for at least 2 seconds to activate/quit the Repeated play.

Music scan

This function can scan each of the music pieces for several seconds. Press the SCN key to activate/quit the Music scan function.

Disc eject (CD)

Press the ▲ key to eject the disc.

Change over the display mode (CD)

Press FUNC key to select the DIS menu.

Press the DIS key and you may have display changeover among the music number/played time, total music time/total music numbers, sound effect mode and clock mode.

Display mode changeover (multi-disc CD)

Press FUNC key to select the DIS menu.

Press the DIS key and you may have display changeover among the music number/played time, total music time/total music numbers, sound effect mode and clock mode.

Troubleshooting

If you find some of the functions of the acoustic apparatus in your vehicle do not work any more, you'd better do a careful reading of the instructions in the manual before having it repaired, and do a check against the list below. And this will be helpful to you in troubleshooting. If the trouble cannot be removed still, please send it to the maintenance station for repair. Do not dismantle and repair it by yourself.

STARTING & OPERATING

BEFORE STARTING THE ENGINE

Before starting the engine, You should always:

1. Look around the vehicle to be sure there are no flat tires, puddles of oil or water or other indications of possible trouble.
2. After entering the car, check to be sure the parking brake is engage.
3. Check your seat, seatback and headrest to be sure they are in their proper position..
4. Check the position of the interior and exterior mirrors.
5. Lock all the doors
6. Fasten your seat belt and be sure that all other occupants have fastened theirs.
7. Turn off all lights and accessories that are not needed.
8. When you turn the ignition switch to "ON" check that all appropriate warming lights are operating and that you have sufficient fuel.

IGNITION SWITCH

WARNING:

The engine should not be turned off or the key removed from the ignition key cylinder while the car is in motion.

"ON"

When the key is in the "ON" position, the ignition is on and all accessories may be turned on. If the engine is not running, the key should not be left in the "ON" position. This will discharge the battery and may also damage the ignition system.

"ACC"

With the key in the "ACC" position, the radio and other accessories may be operated.

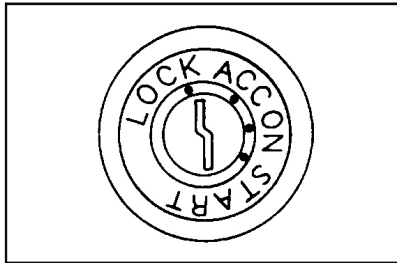

"LOCK"

The key can be removed or inserted in this position. Steering is locked by removing the key.

NOTE: You can remove the key by depressing the knob when the key is in "LOCK" position.

"START"

The position for engine starting when released after starting the engine, the key will return automatically to the "ON" position.

NOTE: Do not hold the key in the "START" position for more than 15 seconds.

TO START THE ENGINE

1. Place the shift lever in neutral and pull the parking brake lever all the way.
2. On vehicle with a cold start feature, set the COLD START switch to "ON" to reduce the warm up period of the engine in very cold weather. The COLD START pilot lamp will light.
3. Insert the key into the starter switch.
4. Depress the accelerator pedal all the way in and place the key to "START" position, and the starter will turn and the engine will start. The engine will be easier to start with the clutch disengaged.

CAUTION:

Points to note at starting

- Do not operate the starter for more than 15 seconds at a time. If the starter is operated for a longer period, the battery will run down or even heat damage to the starter will result.

Do not jab the accelerator pedal but keep it depressed until the engine starts.

- Depress the clutch pedal when starting. Since the starter load is reduced, the engine will be easier to start, particularly in very cold weather.

5. On vehicles with a cold start feature, place the cold start switch to "OFF" after the engine speed has increased.

6. Slowly release the accelerator pedal and turn the fuel button in the direction of 'H' to set the engine speed slightly higher than the idling speed. Allow the engine to warm up for over five minutes until the coolant temperature is raised. Engine warm up is required for circulating oil throughout the engine and raising coolant temperature for proper combustion.

CAUTION:

Do not race the engine during the warm up period, as it could be detrimental to the engine.

7. During the warm up operation, check to ensure that the gauges and meters are performing properly.

8. After the engine warm up operation is over turn the fuel button in the direction of 'L' until the engine runs smoothly at idle speed. For the idle speed, see section II .

STARTING AND STOPPING THE ENGINE FOR TURBO CHARGER (If installed)

1. Do not race the engine or sudden accelerate the engine immediately after start it. If the engine is cold, allow the engine to idle for several seconds before it is driven to ensure sufficient lubrication of the turbo charger unit
2. After high speed or extended driving, requiring a heavy engine load, the engine should be allowed to idle, as shown in the chart below, before turning it off. This idle time will allow the turbo charger to cool prior to shutting the engine off.

Driving Condition		Required Idle Time
Normal driving		Not necessary
High speed driving	Up to 80km/h	About 20 seconds
	Up to 100km/h	About 1 minute
Steep mountain slopes or continued driving in excess or 100km/h		About 2 minute

WARNING:

Do not turn the engine off immediately after it has been subjected to a heavy load. Doing so may cause severe damage to the engine or turbo charger unit.

SELECT LEVER

Manual Transmission

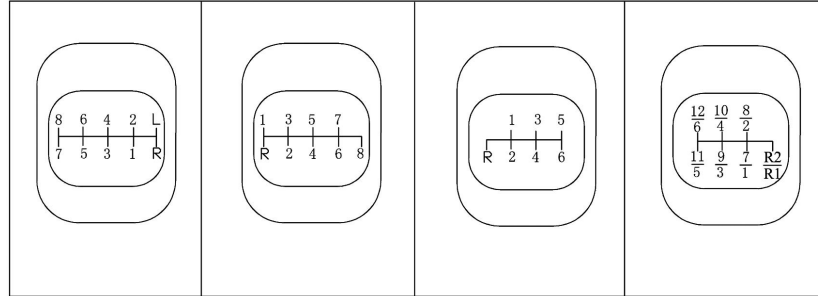

Your Manual Transmission vehicle has a fully synchro-meshed, 8-forward and 1-reverse or 5-forward and 1-reverse speed transmission controlled by a gear shift, lever located on the floor. This shift pattern is shown on the knob.

When shifting the gear shift lever, fully depress the clutch pedal, then release the pedal slowly. Make full use of the gear position.

On 5-speed transmission, shifting to neutral is necessary before Reverse (R).

CAUTION:

- Shift to the reverse position only when the vehicle is completely stopped.
- Do not rest your foot on the clutch while driving, because it will cause needless wear.
- Do not hold your vehicle with the engine when stopped on the upgrade. Use the parking brake.

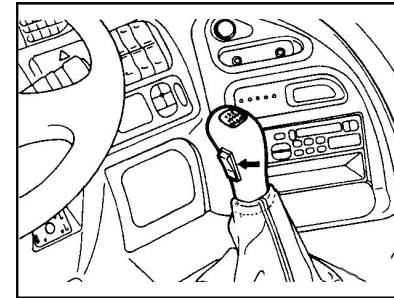



Multi-speed transmission

Shifting

Operate the gearshift lever by the same procedures as for a general vehicle.



Shifting of only splitter between High and Low

Example: 4L→4H

1. Place the splitter control lever to 'H' or 'L'.
2. Release the accelerator pedal and depress the clutch pedal all the way, and automatic changeover will be made to High or Low. Check to see that the  or , indicator lamp is ON.

Simultaneous shifting of both gearshift lever and splitter

Example: 4H→5L or 4L←5H

1. Place the splitter control lever to 'H' or 'L'.
2. Release the accelerator pedal and depress the clutch pedal all the way, and automatic changeover will be made to High or Low. Check the  or  indicator lamp which will light when the changeover is made.
3. Shift the gearshift lever.

When a shift is made, pay attention to the following points

- Place the splitter control lever from "H" to "L" before depressing the clutch pedal.
- When a shift is made from High to Low, make sure that engine speed is below 1,800 rpm. Watch the tachometer to check the engine speed, as at higher speeds engine overrunning could occur after the shift.
- Even if the splitter control lever is accidentally operated during operation, no switchover will be made unless the clutch pedal is depressed. If the lever was accidentally operated, return the lever to its original position immediately.

DRIVING FOR ECONOMY

Observe general operating manners and operate your vehicle on the 'safety first' basis. To conserve fuel, prolong tire life and accomplish others for economical driving follow these suggestions:

- Avoid sharp turns, abrupt acceleration, quick starts and abrupt braking except when unavoidable.
- When accelerating, make an early shift.
- Do not drive with the engine at an abnormally high or low speed.
- Observe proper coolant temperatures of 75 to 90°C(167 to 194°F) when driving. If coolant temperature is too low, it will not only increase fuel consumption but will also be harmful to the engine.
- Maintain proper tire inflation pressures when driving.

ANTI SPIN REGULATOR

Anti spin regulator is a device added to the anti lock brake system. The ASR controls the rear wheels spin according to the friction between a wheel and the road. The ASR makes be stability and bearings for direction when a vehicle starts or turns a corner.

NOTE

If one of the ABS or ASR is out of order the ABS warning light is illuminated. The ASR lamp is on if the engine control line is out of order even though the ASR system is working normally.

Inspection the system

1. Turn the ignition key to the ON position then the ABS warning light will be on and the ASR lamp be also on. Depress the brake pedal and the lights will be off to indicate the system is normal.
2. If the ASR light is illuminated continuously turn the ignition switch off. Try again above procedure and check the light is off. If not, the system should be damaged.

NOTE

Though the system is damaged it is possible to drive the vehicle but be careful in moving on the slippery road.

3. Start your engine.
4. If the speed reach 6-10 km/h the ABS warning light will be off to indicate the system is normal.
5. If not, stop your vehicle and try above procedure No.3 and 4 again. If the light is on continuously the system should be damaged and make it be checked by an authorized JAC service station.

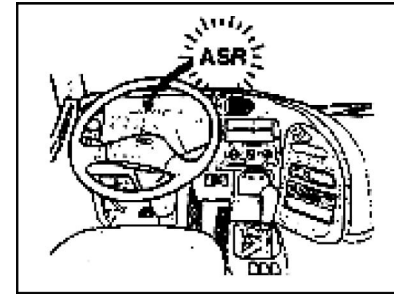

CAUTION

- When the ASR is working RPM can decrease even though the accelerator pedal is depressed fully that is normal condition.
- Generally the acceleration of vehicle with ASR is better as compared with the without it. But the braking is same. Do not over speed.
- The vehicle with ASR/ABS is applied the brake in short time but there is a difference according to the road status. Leave enough room between your car and the car in front.
- On the slippery road especially the frozen pavement the air is cost much by being operated the ABS/ARS. If the brake warning light is on and the buzzer sounds at the same time, pull over the vehicle and wait until the air pressure increases fully.
- When you change the tire is not recommended size, consult an authorized shop.
- It is possible that the vehicle is driven when the system is out of order.

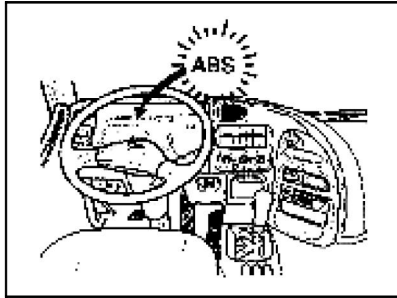

ANTI-LOCK BRAKE SYSTEM(If installed)

The Anti-Lock Brake System (ABS) is designed to prevent wheel lock-up during sudden braking or on hazardous road surfaces. The ABS control module monitors the wheel speed and controls the pressure applied to each brake. Thus, in emergency situations or on slick roads, your ABS will increase vehicle control during braking.

NOTE:

During ABS operation, a slight pulsation may be felt in the brake pedal when the brakes are applied. Also, a noise may be heard in the engine compartment while driving. These conditions are normal and indicate that the anti-lock brake system is functioning properly.

WARNING:

Your ABS will not prevent accidents due to improper or dangerous driving maneuvers. Even though vehicle control is improved during emergency braking, always maintain a safe distance between you and objects ahead. Vehicle speeds should always be reduced during extreme road conditions.

The braking distance for cars equipped with an anti-lock braking system may be longer than for those without it in the following road conditions.

- Driving on rough, gravel or snow-covered roads.
- Driving with tire chains installed.

- Driving on roads where the road surface is pitted or has different surface height.

During these conditions the vehicle should be driven at reduced speeds. The safety features of an ABS equipped vehicle should not be tested by high speed driving or cornering. This could endanger the safety of yourself or others.

GOOD BRAKING PRACTICES

- After being parked, check to be sure the parking brake is not engaged and that the parking brake indicator light is out before driving way.
- Driving through deep water may get the brakes wet. They can also get wet when the vehicle is washed. Wet brakes can be dangerous! Your vehicle will not stop as quickly if the brakes are wet and it may also pull to one side. If you suspect that the brakes may be wet, cautiously apply the brakes. Your brakes are probably wet if the braking action is not normal and requires either more pedal pressure than usual or pulls to one side. To dry the brakes, apply the brakes lightly until the braking action returns to normal, taking care to keep the vehicle under control at all times. If the braking action does not return to normal, stop as soon as it is safe to do so and call the nearest service shop for assistance.
- Don't coast down hills with the vehicle out of gear. This can be dangerous. Keep the vehicle in gear at all times, use the brakes to slow down, then shift to a lower gear so that engine braking will help you maintain a safe speed.

Normal braking

To reduce the speed of the vehicle, first apply engine and exhaust brakes. After the vehicle has slowed down, depress the service brake pedal. When shifting down, use care to prevent engine overrunning.

Depress the brake pedal about 1/2 of the way at a point 25 to 35 m (28 to 38 yd) ahead of the target stopping point.

At a point 5 to 6 m (5.5 to 6.5 yd) ahead of the target stopping point, slowly release the pedal (about 1/2 to 1/3 of the initial stroke). After the vehicle has further approached the target point, slightly depress the pedal to bring the vehicle to a stop. In this manner the vehicle can be gently stopped without shock.

Pay attention to the following points:

- Since the service brakes provide powerful braking, there is no need for depressing the brake pedal all the way except in an emergency.
- If the vehicle is stopped with the initial foot pressure on the brake pedal, shock will be produced when the vehicle stops. Slowly ease foot pressure to minimize the shock. If the brake pedal is fully released, however, all the air in the brake system will be discharged and the vehicle may not stop at the target point but may move further ahead.
- Do not pump the pedal. Frequent pumping will result in temporary loss of the air and the vehicle will move on. In a congested traffic, there is danger of bumping into the rear end of another vehicle ahead. Try to stop the vehicle by depressing the pedal once.
- On air over hydraulic brake vehicles, if the buzzer sounds and BRAKE pilot lamp lights when the pedal is depressed, stop the vehicle immediately. It is the sign of fluid leaks or low brake performance due to excessive brake shoe clearance. Call the nearest service shop for inspection and repair.

The brake system is a completely dual system. Even if fluid leaks occur in one of the circuits, therefore, the vehicle can be stopped through use of the other circuit.

Abrupt braking

In the event of an emergency, depress the brake pedal all the way. The brakes are applied to all wheels and the vehicle stops abruptly. Be careful of strong shock produced when the vehicle stops.

CAUTION:

Frequent use of abrupt braking will result in premature wear of the tires, brake drums, brake linings and other parts and will reduce the life of all parts. Avoid use of abrupt braking except in an emergency. When the road surface is wet as in rainy weather or when there is ice on the road surface, abrupt braking can cause hazardous skidding.

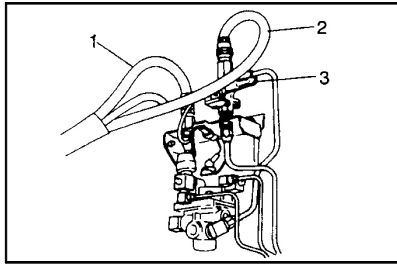

TO COUPLE A TRAILER

- If the trailer is positively coupled, the  indicator lamp in the instrument will light. If the lamp does not light, check

NOTE:

The  indicator lamp will light with the gearshift lever only in reverse

- On a pintle hook equipped vehicle, the  indicator lamp will light when the trailer lock switch (if installed) is pushed in.

After the trailer has been coupled, perform the following step and check:

1. Couple the service 1 and emergency air hoses 2 and open air service valve 3.

NOTE:

Do not confuse the hoses when coupling them.

CAUTION:

When the trailer is to be disconnected, close the air service valves and disconnect the hoses.

2. On a pintle hook equipped vehicle, pull out the cab control valve and shut off the supply of air to the trailer before connecting the service and emergency air hoses.

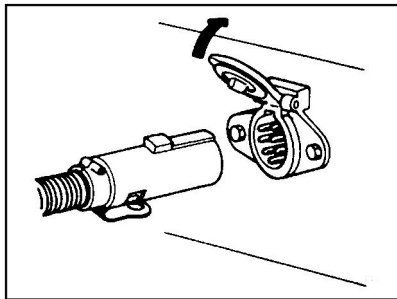

Connect the air hoses and open the air service valve. Then, push the cab control valve in and supply air to the trailer.

3. Connect the jumper cable.

Check to ensure that the stop lamps, tail lamps and turn signal lamps of the trailer light and flash by operating the respective switches.

4. Release the parking brakes of the trailer.
5. Pull the trailer brake lever toward you to check that the trailer brakes apply.

If exhaust air sound is heard when the lever is returned, the brakes are performing well.

BEFORE USING THE TRACTOR COUPLER

Before you use the tractor coupler, you should always;

- Apply grease to each nipple and operating part sufficiently.
- Whenever couple a trailer, apply grease to nipples of base upper part, rolling shaft and bracket sufficiently.
- After cleaning the used grease in containing to foreign matter, apply new grease sufficiently.

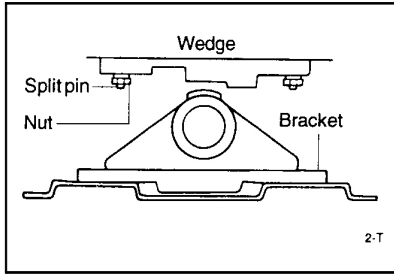

How to adjust rolling angle

- Adjust the rolling angle according to vehicle and driving condition.
- After removing the split pin, loosen the nut by turning it counterclockwise 3 or 4 times.
- Fix the wedge to desired position
- Insert the split pin and bend it after the nut has been tightened.

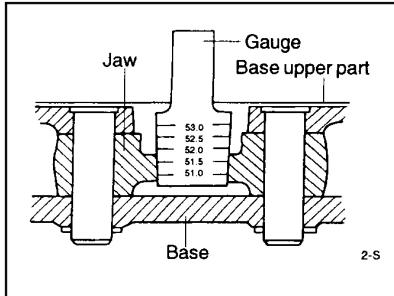

How to adjust inside diameter of jaw

- If the inside diameter of jaw is worn, adjust it.
- Turn the limit dog with a tool counterclockwise.
- Loosen the nut slowly. This will diminish the inside diameter of jaw according to moving yoke forward.
- If its inside diameter is 51-51.2 using the Gauge, tighten the limit dog to adhere the nut perfectly. At this time, check that the gauge could be rotated by hand.

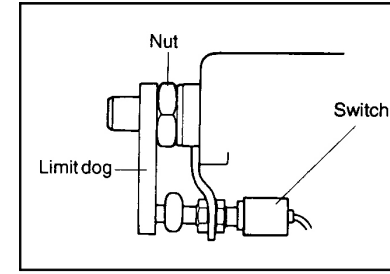

- Before towing, make sure that there is no interference between coupler parts.
- Confirm the adherence state of limit dog and nut, operating state of secondary lock.
- Do not tighten the nut clockwise greater than primary state absolutely.

ADJUSTING BED

By rotating the lever 1, the height of the bed is controlled.

CAUTION:

Be sure not to hurt yourself.

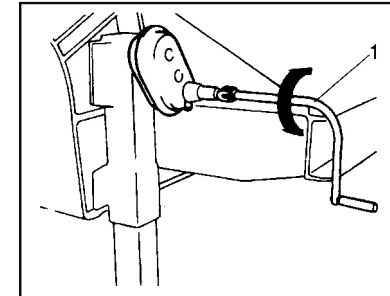

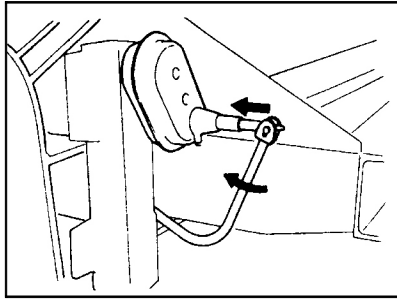

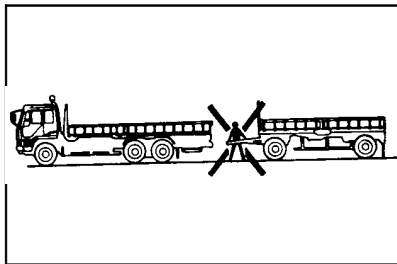

After adjusting bed
Do the adjusting bed lever as shown below before driving vehicle.
Trailer braked and secured by chocks. Drawbar adjusted to coupling height.

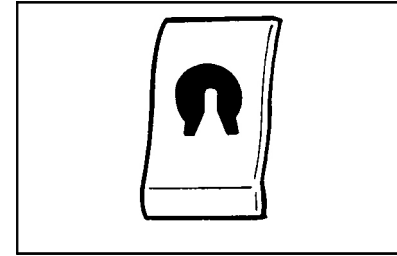

CAUTION:
Be sure no one is standing between tractor and trailer during the coupling operation



TRAILER LOCK SWITCH (If installed)
The trailer lock switch is located on the instrument panel. Use this switch to lock the turntable of the dolly when the vehicle is to reverse. When the switch is pushed, the indicator lamp in the  instrument will light.

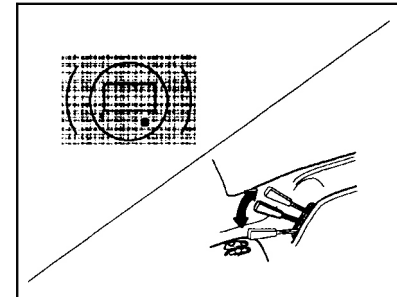

TRAILER BRAKE LEVER
When the lever is pulled toward you, trailer brakes will be applied. Use the brakes when going down a slope. The more the lever is pulled toward you, the stronger the braking power will be come. When the trailer brakes are performing, the  indicator lamp will light.

- Even when the trailer brakes are performing, the service brakes will normally apply.

CAUTION:
Do not use the trailer brakes to slow down the vehicle. Avoid using the trailer brakes for a long period.

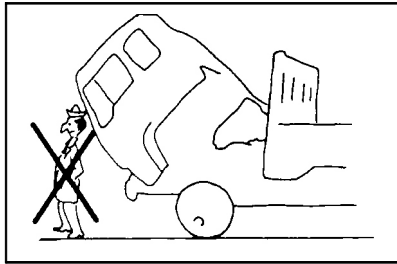

TILTING CAB

To tilt the cab, drive the vehicle to a flat surface and proceed as follows:

1. Apply the parking brake and shift the gearshift lever into neutral. Apply chocks to the wheels and shut off the engine.
2. If there are articles on the seat, they could break the windshield when the cab is tilted.
3. Make sure that the doors are securely closed.
4. Check to ensure that there is enough space around the cab. More than 1 m wide space is required before and above the cab.
5. Before the cab is brought down, check to ensure that there are no waste cloth and other combustible things left behind in the engine room.

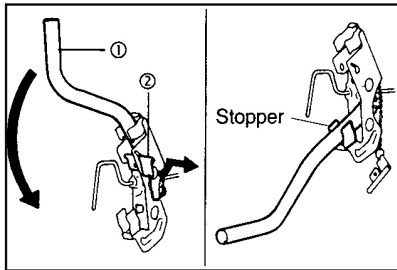

MANUAL TILTING CAB

To raise the cab

1. Remove the hook lever key ② from the lever ①.
2. Pull the lever toward you.

NOTE:

Make sure that the lever is pulled all the way until it touches the stopper. If the lever is not pulled, the hook might not fit in place when the cab is returned.

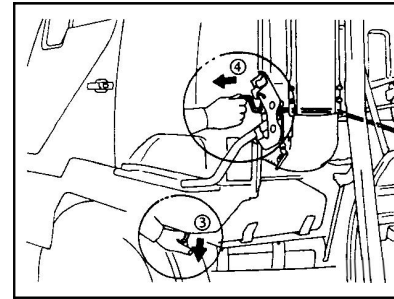

3. Hold the grip ③ of the cab. While pressing it down, pull the safety hook ④.
4. The cab will go up. While pressing it down to prevent abrupt motion, let it go up slowly.

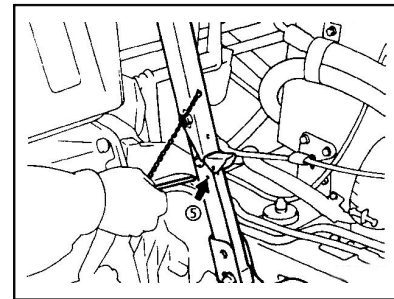

5. Push the cab all the way up, and the cab will be automatically held in position by the cab stay. Insert the safety pin ⑤.

CAUTION:

For safety's sake, make sure the safety pin is inserted.

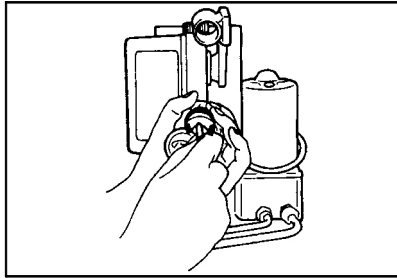

Electric tilting cab (If installed)
To raise the cab

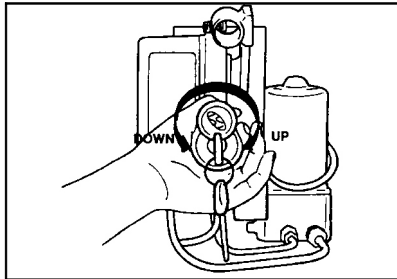

1. Unlock the knob by turning the electric tilting cab key

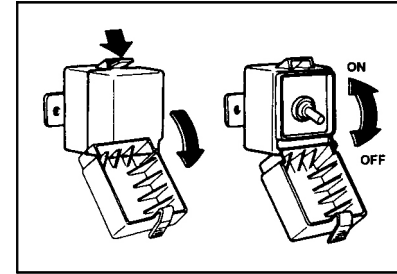

2. Turn the direction knob toward the front of the car.

3. Open the switch cover and flick the switch upwards. The cab will automatically be raised the held in position by the cab stay. The warning buzzer will sound at the same time.
4. Flick the switch down, to stop the warning buzzer.

To lower the cab

1. In the unlocking state of the knob, turn the direction knob toward the rear of the car.
2. Open the switch cover and flick the switch upwards. The cab will automatically be tilted the held in position by the cab stay. The warning buzzer will sound at the same time.
3. Flick the switch down, to stop the warning buzzer.
4. After tilting operation is over, make sure lock the electric tilting cab key and remove it.

NOTE:

Make sure the warning light turns off. If the warning light comes on, it means that the cab has not been locked. In that case, follow the tilting cab operation once again.

The knob has a function of a valve, turn the knob until it fixed.

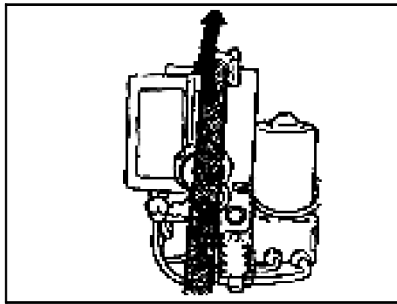

If the electric tilting cab does not operate

It is possible to operate the tilting cab manually:

1. To raise the cab, turn the direction knob clockwise.
2. Insert the jack handle to the socket of the manual pump and operate the jack handle up and down until the cab has been raised. The cab will not rise immediately. It takes a while for the hydraulic pressure to build.
3. Continue operating the jack handle until it does not move.
4. To lower the cab, turn the direction knob counterclockwise.
5. Insert the jack handle to the socket of the manual pump and operate the jack handle up and down until the cab is lowered.

CAUTION:

To tilt the cab more than twice, wait a minimum of 20 minutes. Continuous operation will be harmful to the electric pumping motor.

Operating the vehicle without installing the hook lever key can be dangerous.

Be sure to check that the hook lever key has been installed as a final step.

6. Enter the cab and check to ensure that the warning lamp is OFF.

NOTE:

If the lamp is ON, it means that the cab has not been locked.

Starting and stopping the engine with the cab tilted

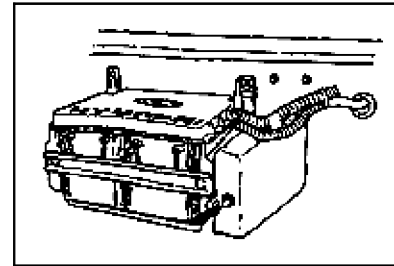

- Turn the ignition key to the "ON" position.
- Shift the gearshift lever into neutral,
- Push the inspection starter switch into start the engine.
- Turn the ignition key to the "ACC" position to stop the engine.

CAUTION:

Since the engine is started with the cab tilted, make sure that the parking brake is applied and chocks applied to the wheels for the sake of safety.

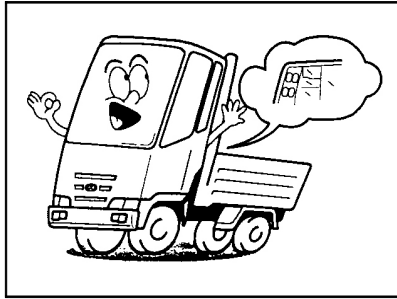

PRECAUTIONS DURING OPERATION

We recommend the following points during operation.

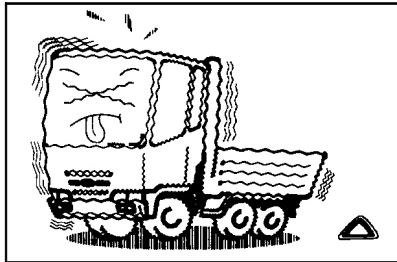

Before driving

- Check to ensure that the meters, pilot lamps and gauges are performing well.
- Release the parking brake lever all the way and confirm that the PARKING BRAKE pilot lamp has gone out.
- When making a start in loaded condition, shift into the 1 st speed gear and make slow start. Extended use of the clutch in half-engaged position will reduce the life of the clutch.



- If strange sound, vibration, unsmooth acceleration, odor or anything wrong is noted, stop the vehicle and check all conditions immediately.
- If the causes cannot be found out or if the correction is impossible, have the vehicle checked by the nearest service shop.
- If hard steering or inadequate brake application occurs during operation, stop and check the vehicle immediately.

- If a pilot lamplights or the buzzer sounds, stop the vehicle immediately. The red pilot lamps should be OFF during operation. If there is any red pilot lamp that is ON, it shows that there is something wrong. Stop the vehicle and check to locate the cause immediately.
- The orange and green pilot lamps will light when the respective switches are turned on .They do not indicated trouble.

CAUTION:

Operation of the vehicle with a red pilot lamp ON can be dangerous. Be sure to stop the vehicle, find the cause and correct defective points promptly. The buzzer will be silenced when the vehicle is stopped and the parking brake lever pulled.

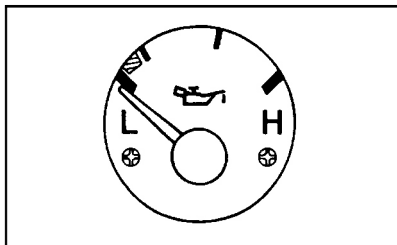

Oil pressure

If the oil pressure falls below 0.5 kgf/cm² (50 kPa) while the engine is idling, the OIL PRESSURE pilot lamp will light and the buzzer will sound.

Stop the engine and check for oil leaks and level at once. If they are good, the oil system is defective. Have the oil system checked by an authorized dealer.

- The OIL PRESSURE pilot lamp also light when the oil filter is clogged. Be sure to check the pressure gauge to confirm the oil pressure.

In severe cold weather the pilot lamp may continue to light for a while after starting because of increased oil viscosity. Do not operate the vehicle until the engine warms up fully.

- Do not keep your foot on the clutch pedal during operation.

Use of the clutch in half-engaged position will not only result in loss of power but will also reduce the life of the clutch.

- The ideal coolant temperature for the engine operation is 75 to 90~C (167 to 194°F).

If the coolant temperature remains at around 100~C (212~F), the engine is slightly overheated. With the vehicle stationary, continue to run the engine to cool it or shift into a lower speed gear to reduce the engine load.

If the pointer passes beyond 110~C (230°F) and enters the red zone, the en-

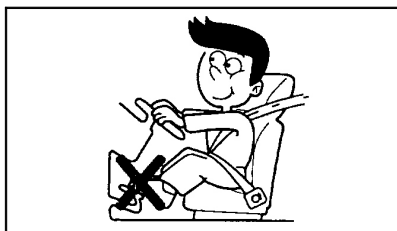

gine is overheated. The water temperature warning light will also light. Stop the vehicle and run the engine at a slightly higher speed than the idle speed to cool the engine.

Do not stop the engine immediately. A sudden rise in coolant temperature could cause seizure of the engine.

When the engine is being cooled, check for coolant leaks. After the coolant temperature has fallen, check for low coolant level or loose or broken fan belt.

CAUTION:

When adding coolant, pay attention to the following points.

- Use city water as coolant. Avoid the use of hard water such as river water if possible.
- When the radiator cap is removed, place a cloth over the cap, raise the pressure release lever and slowly open the cap. If the cap is abruptly opened while the coolant is still hot, the hot water might gush out and might cause scalding.
- If a large amount of cold water is abruptly poured in an overheated engine, cracks might develop in the crankcase, etc. Slowly add water, while keeping the engine running.

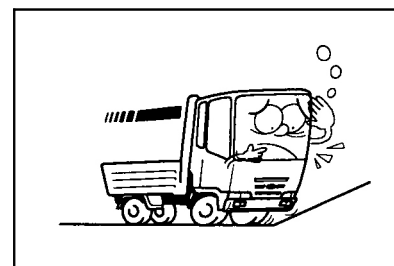

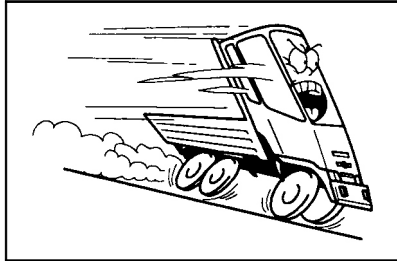

- Same ratio as the coolant in the radiator should be added.
- Before going up a slope, shift down to prevent placing undue load on the engine and drive line.

When going up a slope, maintain a vehicle speed near the maximum torque of the engine.

- Use care to prevent the engine from overrunning.
- Overrunning often occurs when going down a slope or shifting down.
- Engine overrunning occurs when the engine is made to turn beyond the maximum speed by the tires. Undue load on the engine could cause severe engine damage.

CAUTION:

Avoid skipping the next lower speed gear when shifting down, as overrunning readily occurs.

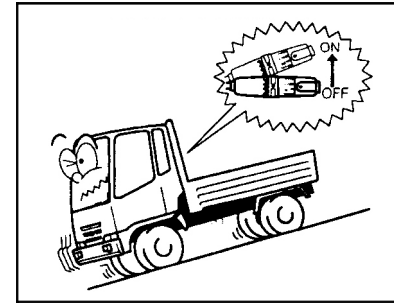

Prior to going down a slope

1. Use engine brake and exhaust brake,
 2. Do not overuse the service brakes.
 3. Use special care not to increase the speed excessively.
- Make sure that the engine does not overrun.
4. Check to be sure that the brakes can be applied properly.

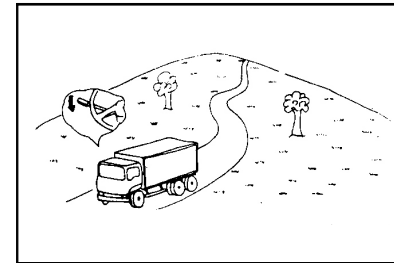

On Tractor

- Apply trailer brakes when going down a zigzag slope.
- Even when the trailer brakes are operative, the service brakes are applied to both the tractor and trailer.

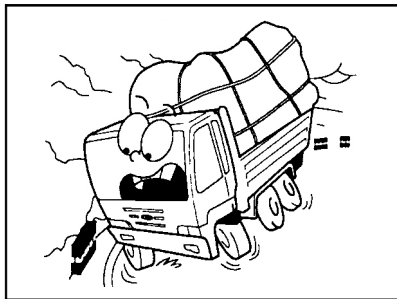
**CAUTION:**

Avoid extended use of the trailer brakes as far as possible.

- When making a turn to the right or left, remember that the rear wheels make a shorter turn than the front wheels.
- Before rounding a curve, reduce the speed of the vehicle.
- Pay attention to the shoulder of the road.

EMERGENCY BRAKE (TRACTOR)

The emergency brakes are spring-operated brakes which are automatically applied to the rear wheels when the compressed air pressure abnormally falls. Observe the following instructions.

How to operate

When the compressed air pressure falls below 2.7 kgf/cm² (265 kPa), the emergency brakes are automatically applied.

Manual emergency brake application can be accomplished by pulling the parking brake knob in. Use the knob in case of emergency.

How to release

When the compressed air pressure fell and the emergency brakes were manually applied, run the engine until the AIR pilot lamp goes out. Thereafter, push the parking brake knob to release the emergency brakes.

Since the pressure might fall temporarily after the release, be sure to check the pressure before starting the vehicle.

CAUTION:

If the AIR pilot lamp is ON when the parking brake knob is pushed, the brakes will not be fully released, and brake dragging will result. When the AIR pilot lamp is ON, therefore, do not push the knob.

If the emergency brakes are automatically applied due to a defective brake line, the compressed air pressure does not rise so cannot be pulled. Release the brakes in the following sequence:

Pull the knob of the cab control valve.

Since the standby tank is used for emergency brake release, remember that the emergency brake release can be made only about twice.

- When the air in the standby tank has been fully consumed, the tire inflation pressure may be employed. For this purpose, however, special tools are required. Ask your nearest service shop.

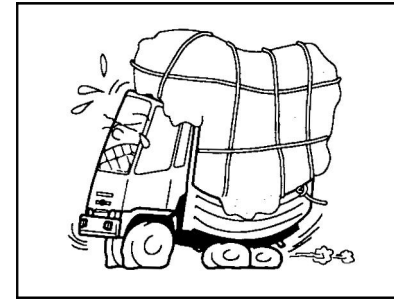

BE SURE TO CHECK THE FOLLOWING WHEN LOADING

Do not load cargo on one side only. Make sure that cargo is evenly distributed.



When long cargos are to be loaded, use rigid frames to minimize their protrusion from the rear end of the body.

NOTE:

Be careful about the height of loading.

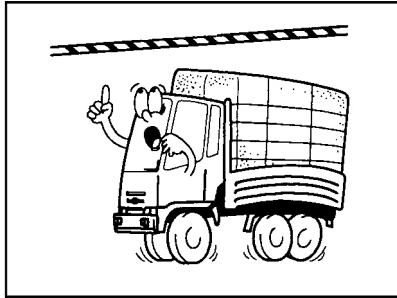

- When the rigid frames are used under the cargo, pay attention to the positions of the frames.
- Place a sheet over the cargo and positively fasten the ropes to prevent the cargo from getting out of position. Make sure that the sheet is securely fastened and does not flap with the wind.

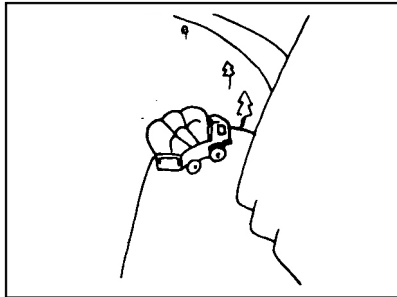

- If cargo is loaded to an excessive height, the vehicle might overturn on turns.
- If the engine shuts down because of lack of fuel during operation, the air will enter the fuel system and the engine won't start even after the fuel tank is refilled.

After fuel has been added, bleed the fuel system according to front

IN CASE OF EMERGENCY

IF THE ENGINE WILL NOT START**CAUTION:**

If the engine will not start, do not push or pull the car to start it. This could result in a collision or cause other damage.

If Engine Doesn't Turn Over or Turns Over Slowly

1. Check the battery connections to be sure they are clean and tight.
2. Turn on the interior light. If the light dims or goes out when you operate the starter, the battery is discharged.
3. Do not push or pull the vehicle to start it. See instructions for "Jump Starting" on the following pages.

If Engine Turns Over Normally but Does Not Start

1. Check fuel level.
2. Check injection pump nozzle.
3. If engine still refuses to start, call a JAC dealer or seek other qualified assistance.

JUMP STARTING**WARNING:**

The gas produced by the battery during the jump-start operation is highly explosive. If these instructions are not followed exactly, serious personal injury and damage to the vehicle may occur. If you are not sure how to follow this procedure, seek qualified assistance. Automobile batteries contain sulfuric acid. This is poisonous and highly corrosive. When jump starting, wear protective glasses and be careful not to get acid on yourself, your clothing or on the car.

- If you should accidentally get acid on your skin or in your eyes, immediately remove any contaminated clothing and flush the area with clear water for at least 15 minutes.

- Then promptly obtain medical attention. If you must be transported to an emergency facility, continue to apply water to the affected area with a sponge or cloth.
- The gas produced by the battery during the jump-start operation is highly explosive. Do not smoke or allow a spark or open flame in the vicinity.
- The battery being used to provide the jump start must be 24-volt. If you cannot determine that it is a 24-volt battery, do not attempt to use it for the jump start.
- To jump start a car with a discharged battery, follow this procedure exactly:
 1. If the booster battery is installed in another vehicle, be sure the two vehicles are not touching.
 2. Turn off all unnecessary lights and accessories in both vehicles.
 3. Attach the clamps of the jumper cable in the exact order shown on the previous page. That is, first, attach one clamp of the jumper cable to the positive (+) post or cable of the discharged battery. Then attach the other end of the same cable to the positive (+) post or cable of the booster battery. Next, using the other cable, attach one clamp to the negative (-) post or cable of the booster battery. Then attach the other end of that cable to a solid metal part of the engine away from the battery. Do not connect the cable to any moving part.
 4. Start the engine in the car with the booster battery and let it run for a few minutes. This will help to assure that the booster battery is fully charged. During the jumping operation, run the engine in this vehicle at about 1000 rpm.
 5. Start your engine using the normal starting procedure. After the engine starts, leave the jumper cables connected and let the engine run at fast idle or about 1000 rpm for several minutes.
 6. Following the exact reverse order of their being attached, carefully remove the jumper cables. Remove the negative



cable first, then the positive cable.

If you do not know why your battery became is charged (because the lights were left on, etc.), have the charging system checked by your JAC dealer.

IF THE ENGINE OVERHEATS

If your temperature gauge indicates overheating, you experience a loss of power, or hear loud pinging or knocking, the engine is probably too hot. If this happens, you should:

1. Pull off the road and stop as soon as it is safe to do so.
2. Place the gear selector lever in neutral and set the parking brake. If the air conditioner is on, turn it off.
3. If coolant is running out under the vehicle or steam is coming out from the cap, stop the engine. Do not open the cap until the coolant has stopped running or the steaming has stopped. If there is no visible loss of coolant and no steam, leave the engine running and check to be sure the engine cooling fan is operating. If the fan is not running, turn the engine off.
4. Check to see if the water pump drive belt is missing. If it is not missing, check to see that it is tight. If the drive belt seems to be satisfactory, check for coolant leaking from the radiator, hoses or under the vehicle. (If the air condi-

tioner had been in use, it is normal for cold water to be draining from it when you stop).

WARNING:

While the engine is running, keep hands, long hair and clothing away from moving parts such as the fan and drive belts to prevent injury.

5. If the water pump drive belt is broken or coolant is leaking out, stop the engine immediately and call the nearest JAC dealer for assistance.

WARNING:

Do not remove the radiator cap when the engine is hot. This may allow coolant to be blown out of the opening and cause serious burns.

6. If you cannot find the cause of the overheating, wait until the engine temperature has returned to normal. Then, if coolant has been lost, carefully remove the radiator cap and add water to bring the fluid level in the reservoir up to the halfway mark.
7. Proceed with caution, keeping alert for further signs of overheating. If overheating happens again, call a JAC dealer for assistance.

CAUTION:

Serious loss of coolant indicates there is a leak in the cooling system and this should be checked as soon as possible by a JAC dealer.

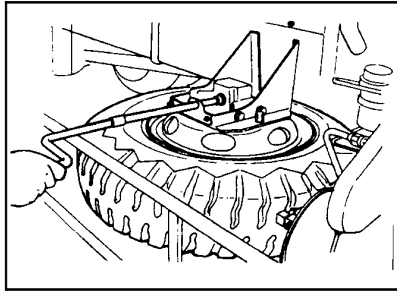

SPARE TIRE

1. Insert the spare tire carrier handle, a vehicle-borne tool, into the hole in the spare tire carrier and turn counterclockwise, and the tire will come down.

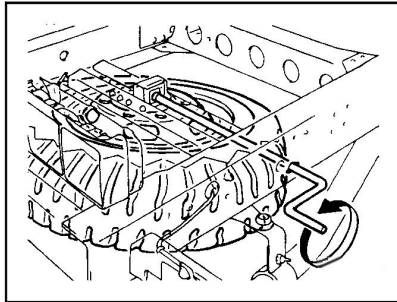

2. To install a tire, face the convex side of wheel upward, put the hanging plate in the disc wheel, and rotate the spare tire carrier handle clockwise to lift the tire.

NOTE:

While lifting the tire, check to ensure that the chain is not twisted and that the hanging plate is not displaced.

3. Check to ensure that the tire has been firmly secured.

NOTE:

The spare tire should also be inflated to specifications and should be checked for external damage and wear.

CAUTION:

If the spare tire cannot be firmly secured, store the spare tire in the rear body or cab and have inspection made at your nearest service shop.

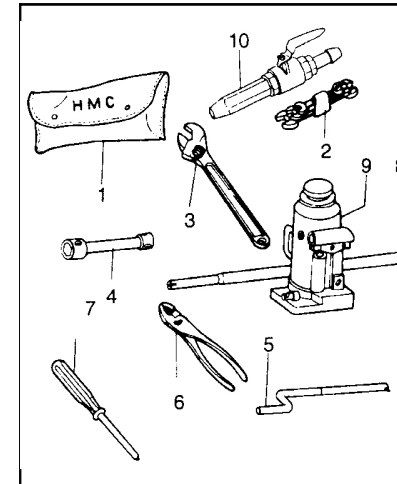

TOOLS

1. Tool set case
2. Spanners
3. Angle wrench
4. Socket wrench
5. Spare tire handle
6. Plier
7. Screw driver
8. Jack handle
9. Hydraulic jack

NOTE:

Please drive after fixing jack with belt in the tool box.

IF YOU HAVE A FLAT TIRE

If a tire goes flat while you are driving

1. Take your foot off the accelerator pedal and let the car slow down while driving straight ahead. Do not apply the brakes immediately or attempt to pull off the road as this may cause a loss of control. When the car has slowed to a speed when it is safe to do so, brake carefully and pull off the road.

Drive off the road as far as possible and park on firm, level ground. If you are on a divided highway, do not park in the median area between the two traffic lanes.

2. When the car is stopped, turn on your emergency hazard flashers, set the parking brake and put the transaxle in reverse.

3. Change the tire following the instructions provided on the following pages.

CHANGING A FLAT TIRE

The procedure described on the following pages can be used to rotate tires as well as to change a flat tire. When preparing to change a flat tire, check to be sure the gear selector lever is in reverse gear and that the parking brake is set, then:

1. Obtain Spare Tire and Tool

Remove the spare tire and take out the jack, jack handle, and tool bag from the tool box.

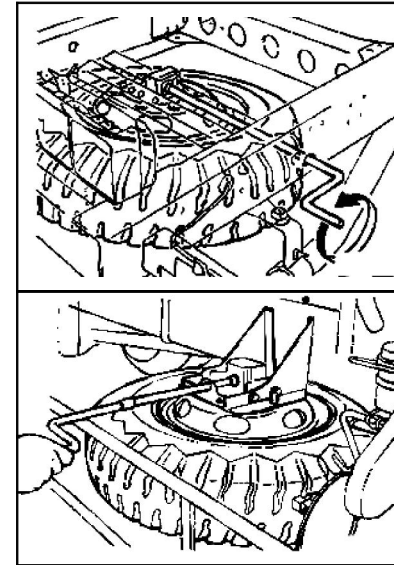

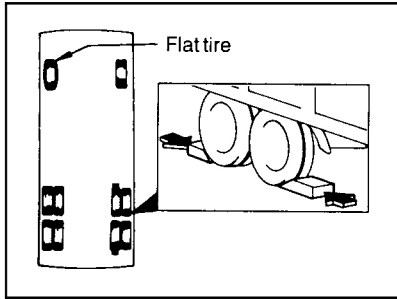

2. Block the Wheel

Block the wheel that is diagonally opposite from the flat to keep the vehicle from rolling when the car is raised on the jack.

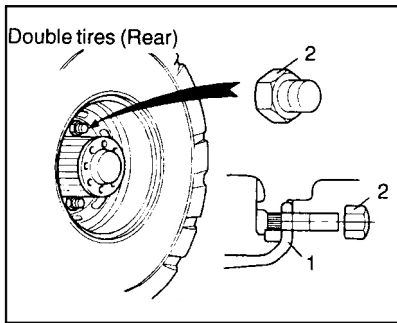

3. Loosen Wheel Nuts

The wheel nuts should be loosened slightly before raising the car.

- 1) Tire wheel
- 2) Wheel nut

NOTE:

Make sure that the rear outer tires are raised on a jack when they have to be replaced. Do not attempt replacing the outer tire with the inner tire placed on a kerb stone.

CAUTION:

Be careful not to hurt yourself when changing a flat tire.

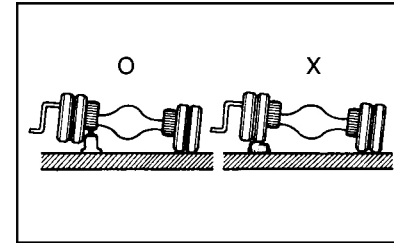

JACK POSITION

The base of the jack should be placed on firm, level ground. The jack should be positioned as shown in the drawing.

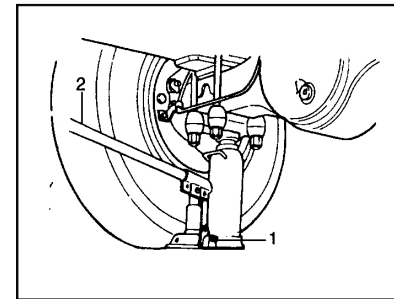

RAISING THE CAR

Install the jack handle into the jack as shown in drawing. To raise the vehicle, close the valve 1 by turning it clockwise and move the jack handle 2 up and down.

WARNING:

Do not get under the car when it is supported by the jack! The vehicle could fall and cause serious injury or death. No one should stay in the car while the jack is being used.

CHANGING WHEELS

Use the wrench to loosen the wheel nuts, then remove them with your fingers. Remove the wheel, slide the wheel off the studs and lay it flat so it cannot roll way.

To re-installed the wheel, put the wheel on the hub and put the wheel nuts on the studs and tighten them finger tight.

LOWER VEHICLE AND TIGHTEN NUTS

To lower the car to the ground, turn the valve 1 counterclockwise by the jack handle.

Then position the wrench as shown in the drawing and tighten the wheel nuts.

* Wheel nut tightening torque:

8 studs wheel :706 to764 N.m (72 to 78 kg.m)

10 studs wheel :578 to 666 N.m(59 to 68 kg.m)

NOTE:

Wheel nut maintenance interval

1. After driving your vehicle during first 1,000km, retighten the wheel nuts with the specified torque.
2. And then, wheel nuts should be checked or retightened for every 5,000km or a month.
3. After replacing the tire, if you drive your vehicle for 50~100km, then the wheel nut should be retightened.

TIRE INFLATION PRESSURES

Low tire inflation pressures could cause overheating and burst of the tire. High tire inflation pressures, on the other hand, will drastically reduce tire life.

When tires were replaced, be sure to adjust the tire inflation pressures to the standard values.

- The standard tire inflation pressure caution plate at the right side of the driver's seat shows the maximum tire inflation pressures for operation on the general road. To extend tire life, it is advisable that the tires are adjusted to the inflation pressures calculated from the load.

Precautions for adjustment of tire inflation pressures

- Adjustment should be made while the tires are cold before operation.
- In the case of double tires, make sure that there is no difference in inflation pressure between the tires. If there is a difference, the higher inflated tire will suffer premature wear and damage, and the lower pressure one will also be adversely affected.
- During operation or immediately after operation, the tire inflation pressures will increase because of the heat. Since the increase of tire inflation pressure during operation is not an abnormal condition, do not deflate the tires.
- The tire inflation pressures need not be increased for high speed operation.

When tires are replaced, pay attention to the following points:

1. New tires should be first installed to the front wheels and subjected to break-in operation before they are moved to the rear wheels. Since the new tires grow during the initial period of use, adjust their inflation pressures after break-in operation.

Break-in operation should be performed at 60 km/h (37 mph) or lower speed over a distance of more than 200 km (124 miles).

2. Use tires of the same brand, size, pattern and plies. Avoid mixed use of different types of tires, as there is a danger of deterioration in handling and stability.

3. The difference in outside diameter between the inner and outer tires of the double tire should be limited to 12 mm (0.47 in.) or less. If there is a difference, install the smaller diameter tire inside.

4. Since snow tires are slightly different in size from general tires of the same size, avoid mixed use of a snow tire and general tire as double tire.

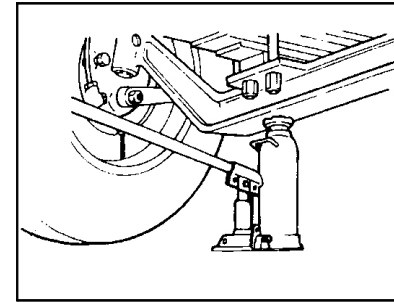

HOW TO USE THE JACK

Put the Jack in Place

The base of the jack should be placed on firm, level ground. The jack should be positioned as shown in the drawing.

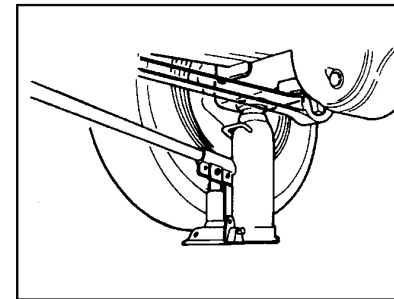

THE POSITION OF REAR WHEEL

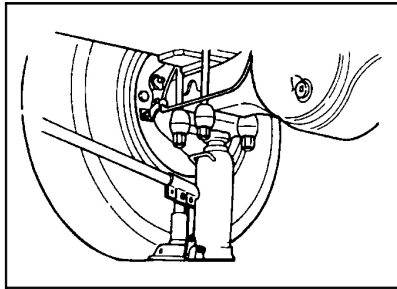

THE POSITION OF REAR WHEEL

NOTE:

Do not place the jack under Rod-Radius.

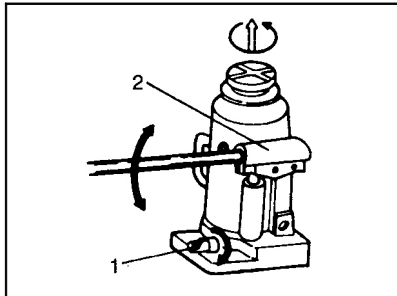

HOW TO OPERATE THE JACK

To raise

If the jack-up point is high, extend the jack by turning the jack head counterclockwise. Close the valve 1 by turning it clockwise and then insert the wrench handle into the socket 2 and move it up and down.

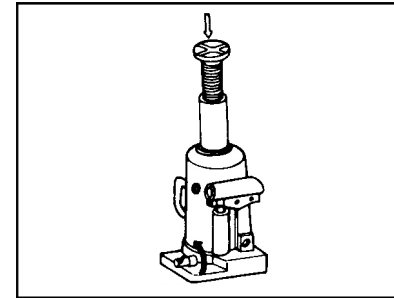

To lower

Turn the valve counterclockwise by the wrench handle.

NOTE:

After using, push the jack all the way down and close the valve.

CAUTION:

Do not overload when raising the jack.

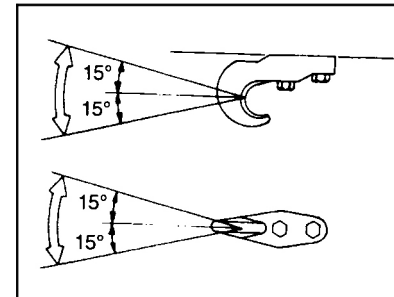

TOWING

When using the towing hook, observe the following:

Make sure that the towing angle of hook does not exceed the limits shown in illustration. Make sure that no load is abruptly placed on the towing hook.

NOTE:

The angles specified in illustration hold good when your vehicle is towed by a towing vehicle about the same size.

When your vehicle is towed, pay attention to the following points

- Use strong ropes and fasten the ropes to the hooks in such a way that they won't be allowed to come off.

- Do not stop your engine. The engine power is needed for supplying compressed air for the brakes and operating the power steering system.
- Be sure that the transaxle is in neutral. Also, be sure that ignition key is in the "ON" position .

CAUTION:

- When your vehicle is towed, remove the rear axle shafts.
- When your engine or brakes are defective, make sure that your vehicle is towed by a towing vehicle designed for the purpose.
- The engine brake, exhaust brake and parking brakes (air over hydraulic brake vehicle) do not function.

Precautions when the vehicle fails

- If anything goes wrong during operation, calm yourself and gradually reduce the vehicle speed, while paying attention to the vehicles behind, and stop the vehicle at a point the closest to the shoulder of the road.
- Set the hazard warning switch to "ON" to make the hazard lamps flash. At the same time, place a red flag or a red lamp for indication of the trouble. If the indication of the trouble is not made, there is a danger of an approaching vehicle bumping into your vehicle.
- Be sure to apply chocks to the tires. If the propeller shaft or rear axle is defective, the parking brakes might not be applied.
- Check the faulty point. If you can correct it yourself, proceed after making sure that neither your safety nor other's will be jeopardized.
- If you cannot correct the trouble yourself, contact the nearest service shop.

APPEARANCE CARE

PROTECTING YOUR JAC FROM CORROSION

By using the most advanced design and construction practices to combat corrosion, JAC produces cars of the highest quality. However, this is only part of the job. To achieve the long-term corrosion resistance your JAC can deliver, the owners cooperation and assistance is also required.

Common Causes of Corrosion

The most common causes of corrosion on your car are:

- Road salt, dirt and moisture that is allowed to accumulate underneath the car.
- Removal of paint or protective coatings by stones, gravel, abrasion or minor scrapes and dents which leave unprotected metal exposed to corrosion.

High-Corrosion Areas

If you live in an area where your car is regularly exposed to corrosive materials, corrosion protection is particularly important. Some of the common causes of accelerated corrosion are road salts, dust control chemicals, ocean air and industrial pollution.

Moisture Breeds Corrosion

Moisture creates the conditions in which corrosion is most likely to occur. For example, corrosion is accelerated by high humidity, particularly when temperatures are just above freezing. In such conditions, the corrosive material is kept in contact with the car surfaces by moisture that is slow to evaporate.

Mud is a particular enemy of corrosion protection because it is slow to dry and holds moisture in contact with the vehi-

cle. Even though the mud appears to be dry, it can still retain moisture and promote corrosion.

High temperatures can also accelerate corrosion of parts that are not properly ventilated so the moisture can be dispersed. For all these reasons, it is particularly important to keep your car clean and free of mud or accumulations of other materials. This applies not only on the visible surfaces but particularly to the underside of the car.

TO HELP PREVENT CORROSION

You can help prevent corrosion from getting started by observing the following:

Keep Your Car Clean

The best way to prevent corrosion is to keep your car clean and free of corrosive materials. Attention to the underside of the car is particularly important.

- If you live in a high-corrosion area where road salts are used, near the ocean, areas with industrial pollution, acid rain, etc. You should take extra care to prevent corrosion. In winter, hose off the underside of your car at least once a month and be sure to clean the underside thoroughly when winter is over.
- When cleaning underneath the car, give particular attention to the components under the fenders and other areas that are hidden from view. Do a thorough job; just dampening the accumulated mud rather than washing it away will accelerate corrosion rather than prevent it. Water under high pressure and steam are particularly effective in removing accumulated mud and corrosive materials.
- When cleaning lower door panels, rocker panels and frame members, be sure that drain holes are kept open so that moisture can escape and not be trapped inside to accelerate corrosion.

APPEARANCE CARE

In order to maintain the value of your vehicle, it is necessary to perform regular maintenance using the proper procedure. Be sure to maintain your vehicle in compliance with any pertinent environmental pollution control regulations. Carefully select the materials to be used for washing, etc. to be sure that they do not contain corrosives; if in doubt, contact an authorized JAC dealer for assistance in the selection of these materials.

Washing

Chemicals contained in the dirt and dust picked up from the road surface can damage the paint coat and body of your vehicle if left in prolonged contact.

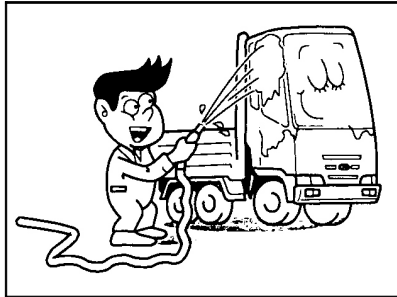

Frequent washing is the best way to protect your vehicle from this damage. This will also be effective in protecting it from environmental elements such as rain, snow, salt air, etc. Do not wash the vehicle in direct sunlight. Park the vehicle in the shade and spray it with water to remove dust. Next, using an ample amount of clean water and a vehicle washing brush or sponge, wash the vehicle from top to bottom. Use a mild vehicle washing soap if necessary. Rinse thoroughly and wipe dry with a soft cloth. After washing the vehicle (including washing in an automatic vehicle wash), carefully clean the joints and flanges of the doors, etc. where dirt is likely to remain. Clean the engine room and the bottom of chassis with steam cleaner. Be careful, at this time, not to blow steam onto such electrical devices as starter, generator, etc.

CAUTION:

When washing your vehicle, pay attention to the following points.

- Be sure to stop the engine beforehand.
- Cover the starter, generator and other electrical devices to prevent direct exposure to steam of a steam cleaner or water.
- Do not spray water against the air cleaner inlet and its vicinity.

Waxing

Waxing the vehicle will help prevent the adherence of dust and road chemicals to the paintwork. Apply a wax solution after washing the vehicle, and ply wax at least once every three months.

Polishing

The vehicles should only be polished if the paintwork has become stained or lost its luster. Mat-finish parts and plastic bumpers must not be polished; polishing these parts will stain them or damage their finish.

Spot Cleaning

Don't use gasoline, strong solvents or corrosive cleaning agents. These can damage the finish of the car. To remove road tar, use turpentine on a clean, soft cloth. Be gentle.

To remove dead insects or tree sap, use warm water and mild soap or car-washing solution. Soak the spot and rub gently. If the paint has lost its luster, use a commercial car-cleaning polish.

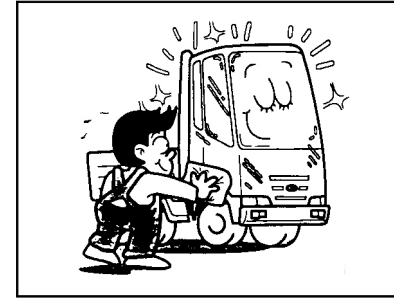

CLEANING THE INTERIOR

To Clean the Vinyl Upholstery

To clean the vinyl upholstery, first remove loose dirt and dust with a vacuum cleaner. Then apply a solution of mild soap or detergent and water using a clean sponge or soft cloth. Allow this to stay on the surface to loosen the dirt, then wipe with a clean damp sponge or cloth. If all the dirt stains are not removed, repeat this procedure until the upholstery is clean. Do not use gasoline, solvent, paint thinner or other strong cleaners.

Cleaning the Carpets

Use a foam-type carpet cleaner. Cleaners of this type are available in aerosol cans in liquid form or powder. Read the instructions and follow them exactly. Using a vacuum cleaner with the appropriate attachment, remove as much dirt from the carpets as possible. Apply the foam following the manufacturers directions, then rub in overlapping circles. Do not add water. These cleaners work best when the carpet is kept as dry as possible.

Cleaning the Seat Belts

To clean the seat belts, use a cloth or sponge with mild soap or detergent and warm water. Do not use strong detergents, dye, bleach or abrasive materials on the seat belts as this may weaken the fabric.

While cleaning the belts, inspect them for excessive wear, cuts, fraying or other signs of damage and replace them if necessary.

Cleaning the Windows

You may use any household window cleaner on the windows.

Any Questions?

If you have any questions about the care of your car, consult your JAC dealer.

VEHICLE MAINTENANCE REQUIREMENTS

SCHEDULED MAINTENANCE

The following maintenance services must be performed to assure good vehicle control and performance. Keep receipts for all vehicle services to protect your warranty.

Where both kilometers and time are shown, the frequency of service is determined by whichever occurs first.

R: Replace I: Inspect and after inspection, clean adjust, repair or replace if necessary

	Interval(Kilometers)×1000	1	5	10	15	20	25	30	35	40	45	50	55	60	65	70	75	80	85	90	95	100	
	Interval(Mile)×1000	0.6	3	6	9	12	15	18	21	24	27	30	33	36	39	42	45	48	51	54	57	60	
NO.	Item																						
Engine Control System Maintenance																							
1	Air,fuel oil coolant for leakage			I		I																	
2	Oil filter	R		R		R		R		R		R		R		R		R		R		R	
3	Air cleaner element		I	I	I	R		I	I	I	R		I	I	I	R		I	I	I	R		I
4	V- belt tention and damage		I	I	I	I		I	I	I	I		I	I	I	I		I	I	I	I		I
5	Injection tightening					I																	
6	Injection pressure and injection condition of the nozzle					I																	
7	Injecting timing																						
8	Fuel feed pump filter			I		I																	
9	Fuel filter	Replace every 2000km~2500km																					
10	Air compressor																						
11	Removal of foreign matter in the fuel tank			I		I		I		I		I		I		I		I		I		I	
12	Valve clearance	Adjust the valve clearance every 40,000km after first adjusment of 5,000km																					
13	Cylinder head bolts	I																					
14	Engine operation condition (Starting,Idling speed,Max speed,Acceleration)	I	I	I		I		I		I		I		I		I		I		I		I	
15	Engine coolant(or every 2 years)				R			R				R				R				R			

	Interval(Kilometers)×1000	1	5	10	15	20	25	30	35	40	45	50	55	60	65	70	75	80	85	90	95	100	
	Interval(Mile)×1000	0.6	3	6	9	12	15	18	21	24	27	30	33	36	39	42	45	48	51	54	57	60	
NO.	Item																						
Power Line																							
1	Transmission oil	I																					
2	Clutch/brake pedal free play and operation condition		I	I	I	I	I	I	I	I	I	I	I	I	I	I	I	I	I	I	I	I	I
3	Clutch oil	Replace every 7 year or 24,000km																					
Driving system																							
1	Rear axle oil		I	I	I	I	I	I	I	I	I	I	I	I	I	I	I	I	I	I	I	I	I
2	Propeller shaft universal jiont,slip jiont&Center bearing						I																
3	Front, rear wheel hub bearing damage&free play							I															
4	Wheel stub bolts and nuts																						
5	Tire pressure and damage																						
6	Tire rotation	Replace every 20,000km~25,000km																					
Steering system																							
1	Power steering gear oil																						
2	Steering system oil leakage																						
3	Overall axle alignment	Adjust the valve clearance every 40,000km after first adjusment of 5,000km																					
4	Steer angle and stopper bolt retightenning	I																					
5	Steering free play & linkage for looseness (in driving the engine)	I	I	I		I		I		I		I		I		I		I		I		I	
Service brake																							
1	Brake fluid							R															
2	Brake system for fluid leakage		I	I	I	I	I	I	I	I	I	I	I	I	I	I	I	I	I	I	I	I	I
3	Brake lining clearance	Inspect and replace if necessary																					
4	Brake lining for wear		I	I	I	I	I	I	I	I	I	I	I	I	I	I	I	I	I	I	I	I	I
5	Brake drum for wear																						

	Interval(Kilometers)×1000	1	5	10	15	20	25	30	35	40	45	50	55	60	65	70	75	80	85	90	95	100	
	Interval(Mile)×1000	0.6	3	6	9	12	15	18	21	24	27	30	33	36	39	42	45	48	51	54	57	60	
NO.	Item																						
Service brake																							
6	Brake pedal free play																						
7	Air dryer	Inspect every 1 year or 50,000																					
8	Air dryer heater plug	Inspect every 2 year or 100,000km																					
Parking brake																							
1	Parking brake function	Inspect every 5,000km and every 2,000km after first adjustment of 5,000km or if necessary																					
2	Drum for wear																						
3	Lining for wear																						
Suspension																							
1	Suspension for damage																						
2	U-bolt *	Adjut the U.bolt every 20,000km after first adjustment of 5,000km or if necessary																					
3	Leaf spring for damage		Inspect every 5,000km or if necessary																				
4	Shock absorbers for oil leakage or damage		Inspect every 5,000km or if necessary																				
Chassis																							
1	Bolts and units on chassis and body		Inspect every 5,000km or if necessary																				
2	Oil for cab tilt	Inspect every 1 year ,replace every 2 year																					
3	Tractor coupler function and kingpin bearing for damage and looseness																						
4	Pintle hook and lunette-rye																						

Engine oil and filter

The engine oil and filter should be changed at those intervals specified in the maintenance schedule. If the car is being driven in severe conditions, more frequent oil and filter changes are required.

Valve clearances

An incorrect valve clearance will not only result in rough engine operation but will also cause excessive noise and reduced engine output.

Inspect valve clearance and adjust as required while the engine is cold.

Fuel lines and connections

Check the fuel lines and connections for leakage and damage. Replace any damaged or leaking parts immediately.

Fuel filter

A clogged filter can limit the speed at which the vehicle may be driven, damage the emission system and cause hard starting. If an excessive amount of foreign matter accumulates in the fuel tank, the filter may require replacement more frequently.

After installing a new filter, run the engine for several minutes, and check for leaks at the connections.

Vacuum and crankcase ventilation hoses

Inspect the surface of hoses for evidence of heat and/or mechanical damage. Hard and brittle rubber, cracking, tears, cuts, abrasions, and excessive swelling indicate deterioration. Particular attention should be paid to examining those hose surfaces nearest to high heat sources, such as the exhaust manifold.

Inspect the hose routing to assure that the hoses do not come in contact with any heat source, sharp edges or moving

component which might cause heat damage or mechanical wear. Inspect all hose connections, such as clamps and couplings, to make sure they are secure, and that no leaks are present. Hoses should be replaced immediately if there is any evidence of deterioration or damage.

Fuel hose, vapor hose and fuel filler cap

The fuel hose, vapor hose and fuel filler cap should be inspected at those intervals specified in the maintenance schedule. Make sure that a new fuel hose, vapor hose or fuel filler cap is correctly replaced. Consult your JAC dealer if you have any questions.

Air cleaner filter

A genuine JAC part is recommended for replacement of the air cleaner filter.

Drive belts

Inspect all drive belts (water pump and alternator) for evidence of cuts, cracks, excessive wear or oiliness, and replace if necessary. Drive belts should be checked periodically for proper tension and adjusted as necessary.

Engine coolant

The coolant should be changed at those intervals specified in the Vehicle Maintenance Requirements Section.

Brake hoses and lines

Visually check for proper installation, chafing, cracks, deterioration and any leakage. Replace any deteriorated or damaged parts immediately.

Brake fluid

Check brake fluid level in the brake fluid reservoir. The level should be between % - and "H" marks on the side of the

reservoir. Use only hydraulic brake fluid conforming SAE J706

Brake drums and linings

Check for scoring, burning, leaking fluid, broken parts, and excessive wear.

Brake pads, calipers and rotors

Check the pads for excessive wear, discs for run out and wear, and calipers for leaking fluid leakage.

Parking brake

Inspect the parking brake system such as parking brake lever, cables, and so on. For detailed service procedures, refer to the Shop manual.

Exhaust pipe connections, muffler and suspension bolts

Check the exhaust pipe, muffler, and suspension connections for looseness or damage.

Steering gear box, linkage and boots

With the car stopped and engine off, check for excessive free-play in the steering wheel, check the linkage for bends or damage. Check the dust boots and ball joints for deterioration, cracks, or damage. Replace any damaged parts.

Wheel bearing grease

Check the wheel bearings and grease according to the maintenance schedule. For inspection procedures, see Shop Manual.

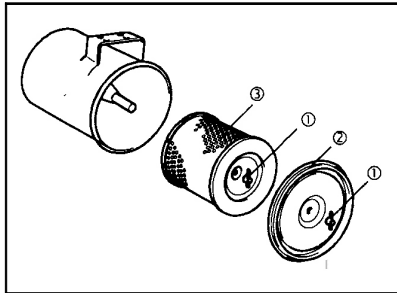

PAPER ELEMENT TYPE AIR CLEANER MAINTENANCE

The air cleaner element should be cleaned or replaced when the dust indicator light in the cluster comes on.

Removal and installation of element

1. Loosen the wing nut ① and remove the cover
- ② straight and withdraw the element ③.

2. Check the element for contamination.

The cleaning procedure varies with the degree of contamination.

3. After cleaning, install by reversing the removal procedure.

NOTE:

The inner element should be replaced when the outer element is replaced.

Note that the inner element is not washable.

CAUTION:

Make sure that the element and cover are securely installed, if they are loose, the cleaner will absorb dust and will fail to function properly.

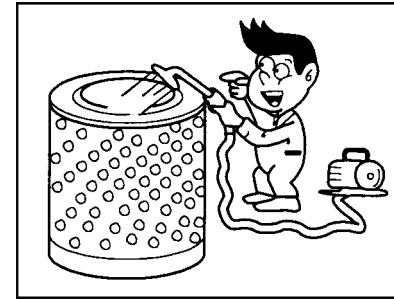

Cleaning of element

Dry dust buildup

Blow clean compressed air evenly up and down from inside the element to loosen and remove the dust.

NOTE:

Do not strike the element or hit it against other object. Make sure that the pressure of the compressed air used for cleaning does not exceed 2 kgf/cm².

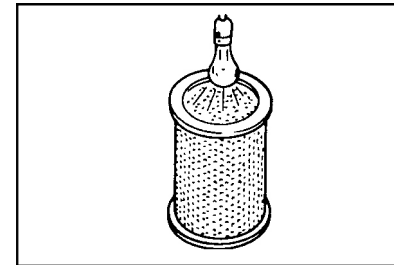

Checks to make after drying

Check the filter paper for damage, pinholes and thin portions. If a defective portion or broken packing is evident, replace the element with a new one.

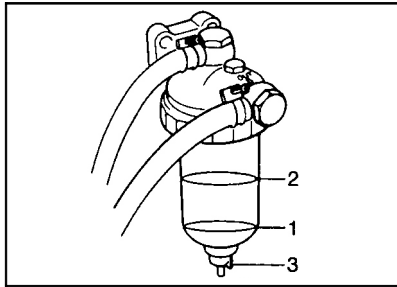

REMOVAL OF CONDENSATE FROM WATER SEPARATOR

Check the water separator about once a week. Remove the condensate before the float 1 in the water separator reaches the position of the red line 2.

To remove the condensate proceed as follows:

1. Loosen the plug 3 to discharge the condensate.
2. After the float has come down, tighten the plug.
3. Wipe clean the water separator and its neighborhood.
4. Check for fuel leaks.

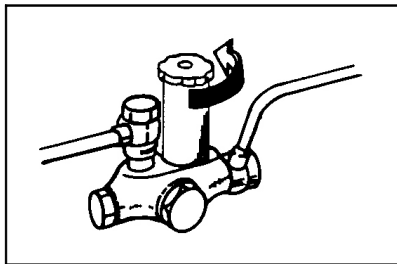

BLEED OF FUEL FILTER

If the engine stops by being used up fuel, cleaning the fuel system or changing the fuel filter the engine does not start through fuel is replenished due to be come air into the fuel system .

Air should be removed from the fuel system to make it start your engine.

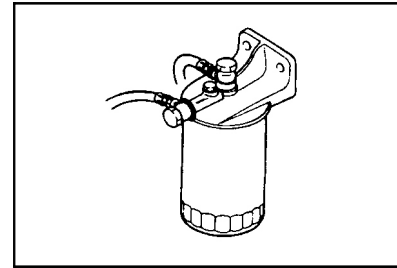

Bleed air by the following procedure

1. Loosen the air bent cock on the top of the fuel filter.
2. Turn the priming pump couterclckwise with pressing down and then the pump piston is pushed out by a spring.
3. Operate the priming pump until the fuel without air bubble flow out.
4. Tighten the air bent cock and fix the pump piston by turning clockwise with pressing down.
5. Start the engine and check for fuel leaks.

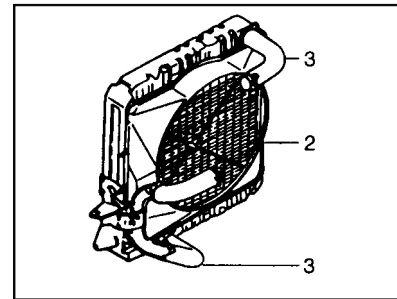

CHECK RADIATOR AND RADIATOR HOSE

Check the radiator 2, radiator hose 3, etc. for water leaks.

Check for the traces of water leaks on the g round where the vehicle has been parked. If there are water leaks in the cooling system, take the vehicle to the nearest service shop for service.

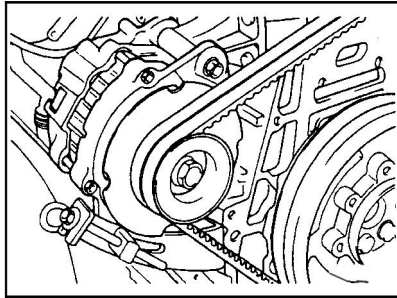

Adjustable Generator freeplay

Slightly loosen the generator attaching bolts and adjust by moving the whole generator.

CAUTION:

- After adjustment, tighten the bolts and nuts firmly. Overtension will cause damage to the V-belt and bearing.
- Make sure that the V-belt is not fouled with oil or grease. Oil or grease will cause the belt to slip and will shorten its life.
- When a V-belt is defective, make sure that the two V-belts are replaced as a set.

REMOVAL OF CONDENSATE WATER FROM AIR TANK

Open all drain cocks to remove the water collected in the air tank.

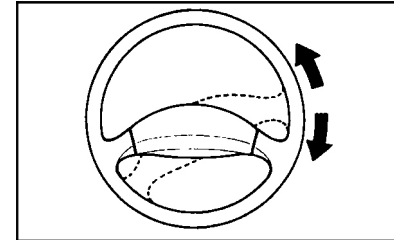
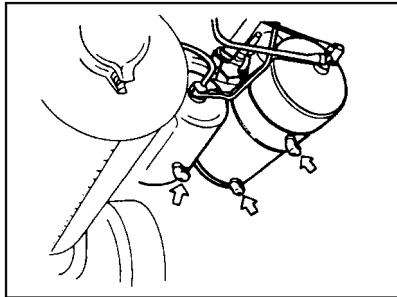

STEERING WHEEL FREE PLAY

Lightly rock steering wheel at the center position to check for free play. If the free play exceeds 15 to 35 mm, have the steering wheel adjusted by your nearest Authorized Dealer.

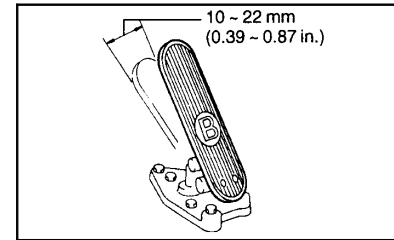

CHECKING BRAKE PEDAL FREE PLAY

Check the pedal free play by depressing the pedal with finger.

The pedal free play is the stroke made by the pedal moves until you feel a change in resistance.

This is the brake pedal free play. The freeplay should be within the limits specified in the illustration below. If it is not, have it inspected by your JAC dealer and adjusted or repaired if necessary.

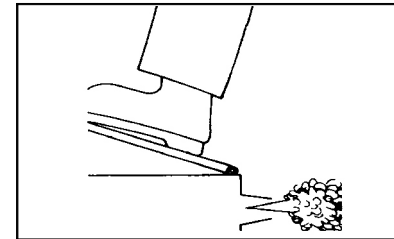

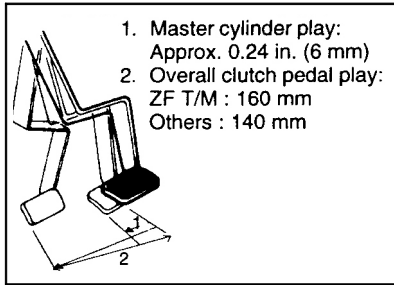

CLUTCH PEDAL PLAY

The clutch pedal play will decrease as the disc wears. If it is not adjusted, the clutch will slip, making it impossible to operate the vehicle. When the clutch pedal play has decreased to less than 8.3 in. (210 mm), adjustment is required.

Check the pedal play by depressing the pedal with finger. Depressing the pedal will make you feel resistance in two stages. The pedal play is the stroke made by the pedal until it reaches the second stage and is 0.24 to 0.31 in. (6 to 8mm) standard. The play in the first stage is the master cylinder play. In the second stage, it is the clutch booster push rod play. The play is easier to check when the compressed air pressure is lower. If it is out of specification, have it inspected and adjusted or repaired if necessary.

Adjust the clutch master cylinder play, which is the movement of the pedal up to the first resistance encountered when the pedal is depressed with your finger. Adjust this play to about 6 mm (0.24 in.) by turning the center belt of the master cylinder push rod. After adjusting, firmly tighten the nut on the center belt while holding the belt in position with a corech.

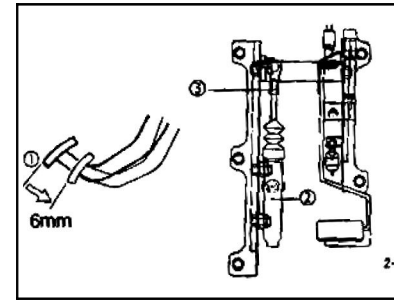

- 1) Master cylinder play:
Approx. 0.24 in. (6 mm)
- 2) Master cylinder
- 3) Play adjusting nut

NOTE:

If the adjustment cannot be made to this play specification, the clutch disc is worn down to the service limit. Take the vehicle to your nearest service facility for correction.

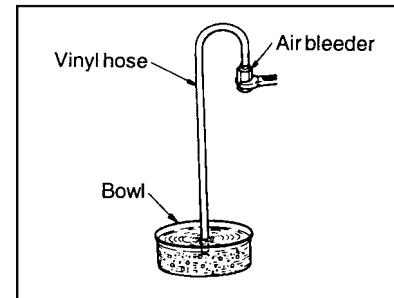

BLEEDING OF CLUTCH PIPING

If there is air in the piping, the clutch will be hard to disengage.

When the fluid reservoir tank has been emptied, be sure that the clutch piping is bled. Have an assistant in bleeding the piping and proceed as follows:

1. Fill the clutch fluid reservoir tank with brake fluid up to the "MAX" level. Since the level falls during the bleeding operation, add brake fluid to prevent emptying the tank.

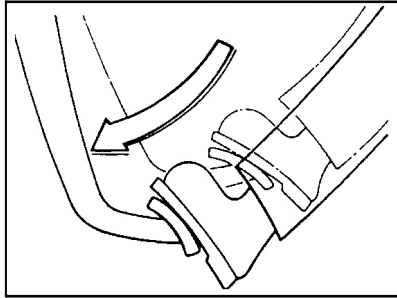

2. Remove the rubber cap from the air bleeder of the clutch booster, mount one end of a transparent vinyl hose, and put the other end in a bowl containing brake fluid.

3. Depress the clutch pedal several times. After the stroke has settled, keep the pedal depressed.

Let the assistant loosen the air bleeder to discharge the air along with the brake fluid. Let him tighten the air bleeder immediately after air has been discharged.

NOTE:

If the brake fluid is discharged from the air bleeder, the stroke of the pedal will change. Tighten the air bleeder immediately after the pedal has touched the stopper.

4. After the air bleeder has been tightened, release the pedal.

5. Repeat steps 3 and 4 until there are no more air bubbles in the brake fluid that runs out from the air bleeder. As a final step, tighten the air bleeder firmly and install the rubber cap.

6. Check the fluid level in the fluid reservoir tank and add brake fluid up to the "H" level. Depress the clutch pedal to check for fluid leaks.

CHECKING THE BRAKES

CAUTION:

Because brakes are essential to the safe operation of the car, it is suggested that they be checked and inspected by your JAC dealer. The brakes should be checked and inspected for wear at those intervals specified in the vehicle maintenance schedule in Section 6-3.

Checking the Brake Fluid Level

WARNING:

Use caution when handling brake fluid. It can damage your vision if it get into your eyes. It will also damage your vehicles paint if spilled on it and not removed immediately.

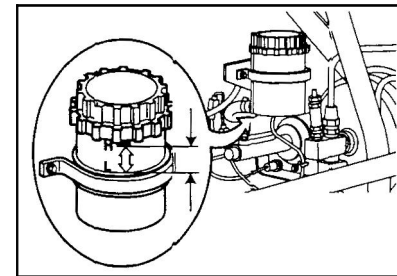

To Check the Fluid Level (If installed)

The fluid level in the brake fluid reservoir should be checked periodically. The level should be between the "L" and "H" marks on the side of the reservoir. If the level is at or below the "L" mark, carefully add fluid to bring it up to "H". Do not overfill.

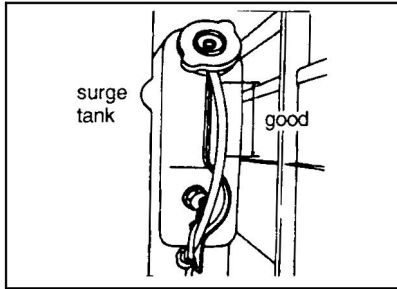

COOLANT LEVEL AND LEAKS IN COOLING SYSTEM

If lamp is illuminated add the coolant after removing the surge tank cap at first.

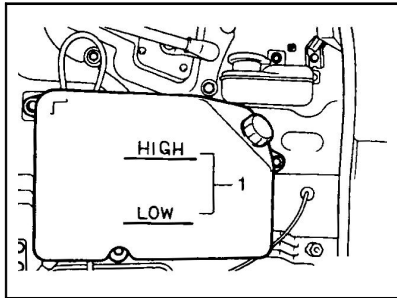

Check reservoir tank for the coolant level. The coolant level should be within the range 1 shown in the illustration. If the level is low, add coolant by reference to "Replacement of coolant".

CAUTION:

- Check the coolant level before vehicle operation while the engine is cold.
- After checking the coolant level, be sure to reinstall the cap positively.
- Be sure to add the coolant containing antirust or anti-freeze of the same concentration as the coolant in the cooling system.
- Do not check the coolant level after the engine has been stopped. Be sure to check the level when the coolant temperature is low.

Checking and changing the engine coolant

WARNING:

Do not remove the surge tank cap when the engine is hot. When the engine is hot, the coolant is under pressure and may erupt through the opening if the cap is removed. You could be seriously burned if you do not observe this precaution.

Do not remove the surge tank cap until the radiator is cool to the touch.

Handling of cooling system

Engine overheating is caused by the low coolant level or rust and scale accumulations in the cooling system. If the radiator clogs very badly or coolant is very dirty, perform cleaning and coolant replacement as described below. If the coolant level is low, add coolant as necessary.

Replacement of coolant

If the radiator clogs badly or coolant becomes dirty, replace coolant immediately regardless of the specified replacement intervals. In making this kind of replacement, be sure to clean the cooling system by the procedure shown in "Cleaning method".

Cleaning method

Run the engine at idle to heat the coolant to 90°C or higher. Then clean by the following procedure.

1. Open the radiator and engine drain cocks to drain the coolant.
2. After complete draining, close each drain cock and fill the system with city water.
3. Close the drain cocks and fill the system with city water. Run the engine for a while and drain the system.

Repeat this operation until a colorless, transparent water flows out from the drain cock.

4. Fill the radiator with city water containing genuine anti-rust 'RADIPET 9' or genuine anti-freeze at a specified concentration. Run the engine until the coolant is heated to the temperature (90°C) at which the thermostat opens, and bleed air thoroughly from the cooling system.

5. Stop the engine and make sure that the coolant is at the proper level. If the coolant level is low, add city water.

CAUTION:

When the cooling system is cleaned, the coolant or cleaning solution is drained at elevated temperature. Therefore, be careful not to get scalded.

Addition of coolant

If the warning lamp lights when the starter switch is set to "ON", the coolant level is low. Note that the procedure for adding coolant varies according to the type of the engine cooling system on vehicle. Use city water as coolant and add anti-rust or anti-freeze to have a specified concentration for prevention of engine or cooling system corrosion.

Do not use hard water from well river etc.

Antifreeze

Select proper concentration between 30 and 53% by reference to the table shown below.

Atmosphere temperature (°C)	Antifreeze fluid (%)	Coolant (%)
-10	30	70
-15	36	64
-20	42	58
-25	45	55
-30	50	50
-35	53	47

CAUTION:

- Be sure to use anti-freeze at the concentration most appropriate for the atmospheric temperature within a range from 30 to 53%. If the concentration is below 30%, the anti-corrosion property will be adversely affected. If the concentration is above 53%, the anti-freeze property will decrease and engine overheating will also be caused. Use anti-freeze at the specified concentration.
- If winter is over, be sure to drain the coolant containing antifreeze and put in genuine anti-rust "RADIPET 9".

ADJUSTMENT OF BRAKE SHOE CLEARANCE

Air over hydraulic brake vehicles

If the brake linings are worn and the clearance between the brake drum and linings (brake shoe clearance) increases, it can be dangerous because the brake performance deteriorates.

If the BRAKE pilot lamp lights, adjust and bleed the system immediately.

Leakage of brake fluid also causes the BRAKE pilot lamp to light. Check for fluid leaks, too.

1. Apply chocks to the tires before the wheel to be adjusted is jacked up.

2. Strongly push the outside periphery of tire with both hands to check for wheel looseness. If the wheel is loose, it cannot be correctly adjusted. Take the vehicle to your nearest service shop for correction.

3. Remove the dust plug from the shoe clearance adjusting hole.

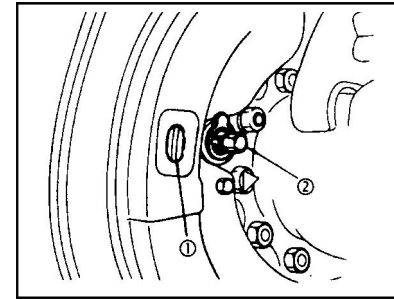

NOTE:

Be sure not to hurt yourself.

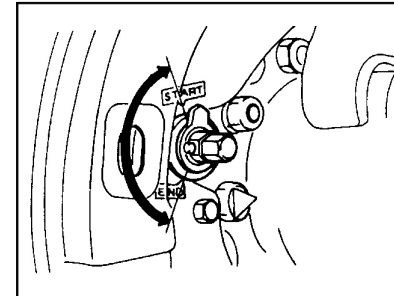

4. Turn the adjusting cam in the direction of the arrow until it is blocked. Slightly back it off.

5. Insert a 0.4 mm (0.016 in.) thickness gauge over the entire width of lining through the adjusting hole and turn the adjusting cam to adjust the clearance to the extent that the thickness gauge can be pulled out with some resistance.

6. Each wheel has two adjusting holes at the front and rear. Be sure to adjust both by the same method.

1) Adjusting hole

2) Adjusting cam

7. After adjustment, check the lining wear indicator of the adjusting cam. If the pointer of the indicator is not in the wear range, the brake linings are worn down beyond the service limit. Have your nearest service shop replace the linings.
8. Turn the wheel in the forward direction and depress the brake pedal to stop rotation of the wheel. Thereafter, turn the wheel to check for dragging. With slight foot pressure on the brake pedal, turn each wheel by hand, ensure that the front wheels are slightly lighter to turn than the rear wheels or there is no gear difference, and that the right and left wheels are about equal.
9. As a final step, install the dust plug. Operate the vehicle at slow speed and make brake tests to check for poor performance, uneven braking and other troubles.

Air brake vehicles

If the brake linings are worn and the clearance between the brake drum and linings (brake shoe clearance) increases, it can be dangerous because the brake performance deteriorates. Check and adjust the brake shoe clearance at regular intervals.

- The brake shoe clearance should be determined on the basis of the stroke of the brake chamber push rod. If the push rod stroke exceeds 40 mm (1.57 in.) on the front wheels or 50 mm (1.97 in.) on the rear wheels when the brake pedal is depressed all the way, adjust the clearance.

1. Apply chocks to the tires before the wheel to be adjusted is jacked up.
2. Strongly push the outer periphery of tire to check for wheel looseness. If the wheel is loose, it cannot be correctly adjusted. Take the vehicle to your nearest service shop for correction.

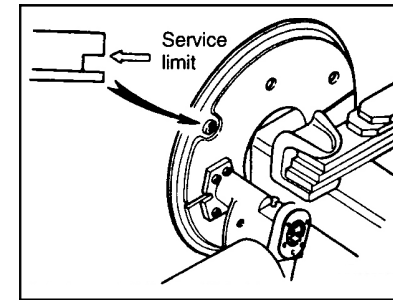

3. Start the engine to increase the compressed air pressure to more than 6.4 kgf/cm² (625kPa). Leave the engine running at idle.
 4. Push the knob of the cab control valve to release the emergency brakes.
 5. Remove the dust cap from the wheel brake inspection hole and check the lining thickness. If the lining is worn down to the notch shown in illustration, it is worn beyond the service limit. Have your nearest service shop replace the linings. Make sure that the dust cap is reinstalled after inspection.
 6. Turn the worm shaft of the slack adjuster in the direction that the push rod extends until the worm shaft touches the stopper.
 7. Back off the worm shaft 3 or 4 notches on the front wheels or 4 or 5 notches on the rear wheels.
- The notches are indicated by the clocks the worm shaft makes when turned.

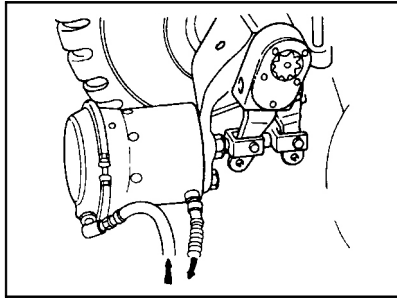

8. Measure the stroke made by the push rod of the brake chamber when the brake pedal is depressed all the way. Verify that the stroke is up to specifications given in the following table if it is out of specification, adjust with the worm shaft.

Standard stroke of brake chamber push rod

Front wheel	25 mm (0.98 in.)
Rear wheel	30 mm (1.18 in.)

9. Turn the wheel in the forward direction by hand and depress the brake pedal to stop rotation of the wheel. Turn the wheel to check for dragging. With slight foot pressure on the brake pedal, turn each wheel by hand to check that the front wheels are slightly lighter to turn than the rear wheels or there is not great difference and that right and left wheels are about equal.

10. As a final step, install the dust plug. Operate the vehicle at a slow speed and perform brake tests to check for brake performance, uneven braking and other troubles.

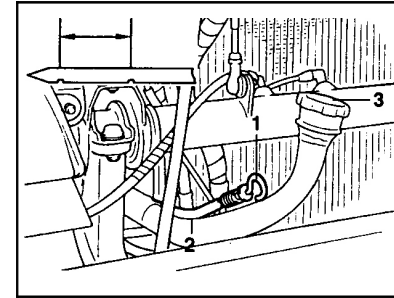

ENGINE OIL LEVEL

Position the vehicle on a level surface. The best time to check the oil level is before operating the engine or about 30 minutes after stop of engine.

The checking procedure is as follows:

1. Wipe the level gauge 1 well with a cloth, insert it into the level gauge guide 2 and remove the gauge to check the oil level. The oil level should be between "FULL" and "LOW" inscribed lines.

CAUTION:

If the oil level is checked when the engine is stopped before sufficient rise of oil temperature, the detected level will be lower than the actual level, because some oil accumulation in the engine does not flow back into the oil pan.

2. If the level is low, add engine oil through the filler cap 3. After addition of engine oil, allow more than six minutes and then recheck the oil level.
3. If a badly contaminated engine oil is obvious when checking the oil level, replace the engine oil irrespective of the service intervals.

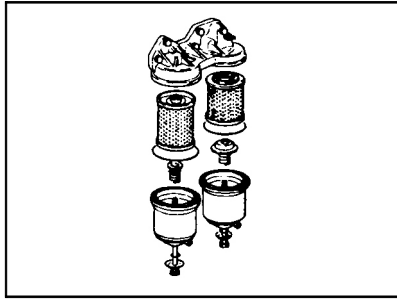

OIL FILTER

- The engine oil and filter should be changed at those intervals specified in the maintenance schedule. If the car is being driven in severe conditions, more frequent oil and filter changes are required.
- If the filter is blocked the warning light is on and if the oil pressure is low the buzzer sounds at the same time. Replace it independent of the mileage.
- An element assembly cannot be reused.

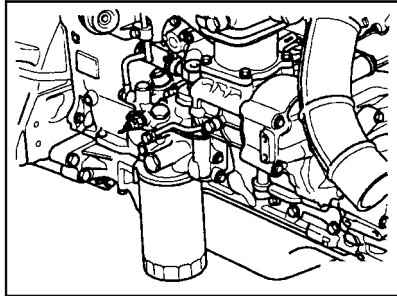

Replacement of filter type

1. Put an empty container below the oil filter drain hose. Remove the air bleeding plug and drain the engine oil out.
2. Disassemble the case by pulling the center bolt on the oil filter out and remove the element.
Use the genuine parts when you assemble. Replace the element and rub packing of the case simultaneous. Apply engine oil on the rub packing before assembling. Tighten the center bolt with specified torque 5.5 ± 0.5 kg.m.
3. When you replace only the oil filter replenish the engine oil.
4. Crank the engine and check the oil leakage and the oil level later.

CAUTION

Be very careful when draining the engine oil as it may be hot enough to burn you. Dropped oil may cause a fire. Wipe and clean each part in the engine room.

Replacement of cartridge type

If the filter is blocked, the warning light is on when the RPM is high.

Replace it independent of the mileage

If the oil pressure decreases the warning light also is on and the buzzer sounds simultaneous. But the parking brake is applied on it does not sound.

1. Put an empty container below the oil filter and remove the drain plug. Drain the engine oil out.
2. When the draining is finished pull the oil filter out with a wrench.
3. Use the genuine parts when you assemble. Assemble the rub packing on top of the filter after applying the engine oil on.
4. When you replace the oil filter replenish the engine oil.
5. Start your engine. Check whether the oil leaks. The checking should be done before driving and after.

CAUTION

Split oil may cause a fire. Wipe and clean each part in the engine room. Never reuse the filter assembly.

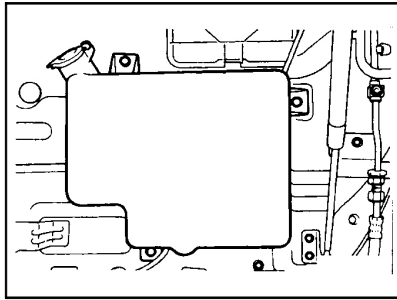

WINDSHIELD WASHER FLUID LEVEL

Check to ensure that windshield washer fluid is at a proper level.

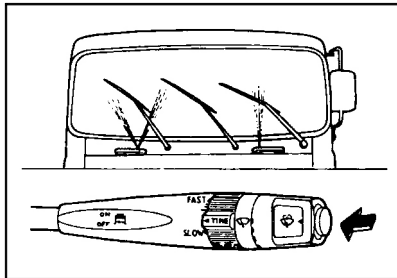

Operation of wipers

- Push the knob to check that the windshield washer fluid is sprayed at the correct position.
- Turn the lever and check the wipers for proper operation.

NOTE:

Be sure to operate the windshield washer before the wipers are operated.

Do not operate the wipers on dry glass,

This can result in more rapid wear of the wiper blades and may scratch the glass.

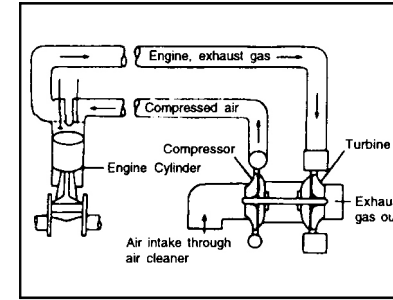

TURBOCHARGER

Principle of turbo charger operation

Turbo engine is a device that produces more power by supplying sufficient air into the combustion chamber by using the energy of exhaust gas is usually wasted in the general engine.

The exhaust gases are accelerated in the turbine housing and directed onto the turbine wheel to turn it.

This spins the compressor wheel, which results in the intake air being forced into the engine cylinders.

As the intercooler is installed that improves the fuel economy and power of the engine, while reducing harmful exhaust gases to a minimum.

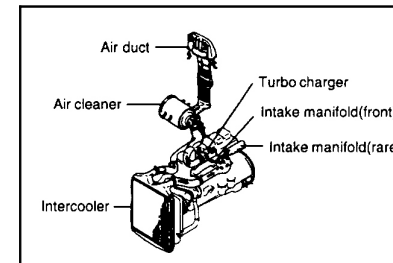

Intercooler

The intake air compressed by the turbocharger increases to 170~C and as a result, power of the engine is limited by engine overheated. The intercooler cools the heat. This improves the combustion efficiency and as a result, it increases that the fuel economy and power of the engine, while reducing harmful exhaust.

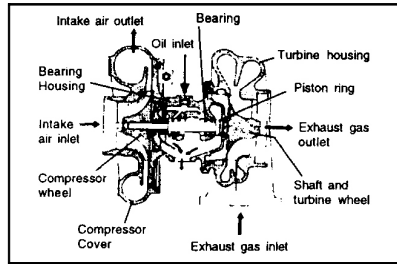

Precautions while operating

1. Check the oil level and oil pressure

Before starting the engine, measure the crankcase oil level. As soon as the engine starts, check oil pressure indicator for normal rise.

2. Warm the engine up

After the engine starts, avoid sudden acceleration or sudden start.

Enough RPM is needed before starting engine until the engine is warm for 3 to 10 minutes.

3. No starting suddenly and No accelerating heavily

If you accelerate heavily, start suddenly or when you turn off the engine suddenly it may damage to the engine and turbocharger parts.

CAUTION

- If running a vehicle without air cleaner filter, foreign material drawn can destroy engine and turbo charger.
- When you turn off an engine suddenly may damage bearing, hi-speed rotation part of turbo charger inside, so let the engine run at idle for sufficient time.

BATTERY INSTRUCTIONS

Check the battery fluid level and specific gravity at regular intervals.

CAUTION:

- The battery generates highly inflammable gases. Take special care not to use a fire or produce sparks near the battery.
- The battery fluid contains sulfuric acid. In case of contact with the skin or clothes, immediately wash away with a large amount of clean water and seek medical help.

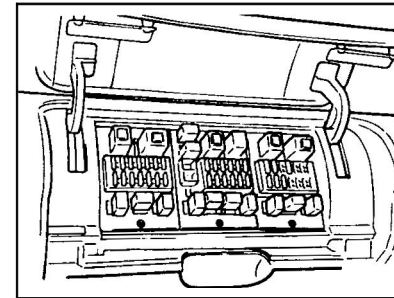

Cleaning of battery terminals

1. Clean the battery terminals if they are stained or corroded. If there is white powder on the terminals, wash with hot water.
2. Remove and polish the terminals with a wire brush or emery paper if they are markedly corroded.
3. Apply a thin coat of grease to the terminals after cleaning and tightening.

NOTE:

The terminals must be firmly tightened. Before cleaning the terminals, make sure the caps are installed securely to prevent foreign matter from entering the battery.

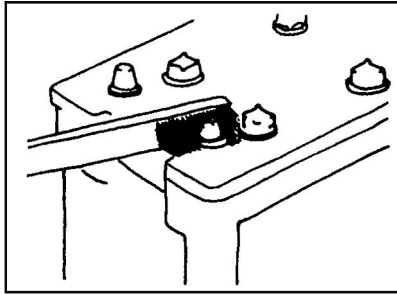

Fluid Quantity

The fluid level should be between the "UPPER" and "LOWER" level lines. If the level is low, add distilled water up to the 'UPPER' line.

NOTE:

If your battery has only one level line, the line indicates the "LOWER" level (lowest).

If your battery has no level line, the fluid level should be between 10 and 15mm above the plates.

If the level is low, add distilled water until it is 15mm above the plates.

NOTE:

After addition of water, be sure to charge the battery (by operating the vehicle), because otherwise the fluid could be frozen in winter.

Specific gravity

Measure the specific gravity. If it is less than 1.220 (at a fluid temperature of 20~C), recharge the battery.

NOTE:

The standard specific gravity of battery is 1.260 to 1.270 (at a fluid temperature of 20~C).

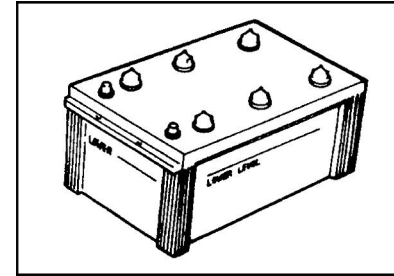

REPLACEMENT OF FUSE

If the electrical system is out of order, open the cover and check for a blown fuse in the following sequence.

1. Open the cover.
2. Remove the circuit checker from the reverse side of the cover.
3. Insert the female terminal of the circuit checker into 'CHECKER' ground terminal and touch the male terminal to the fuse top surface.
4. If the lamp lights, the fuse is good.

The headlamp circuit should be checked with the head light switch at lighting position.

5. Replace the defective fuse.

CAUTION:

- Use of a fuse out of specification or wire could be dangerous. Be sure not to use a substitute fuse. Make sure that a blown fuse is replaced with a genuine fuse. If a defective point cannot be located, have inspection made at your nearest service shop.

- Do not pour water over the relay and fuse box. Do not put your foot on the box or kick it. When the inside of the cab was cleaned with water, remove the water completely through the drain hole in the floor and then tilt the cab.

CENTRALIZED LUBRICATION SYSTEM(If installed)

C.L.S (Centralized Lubrication System) is the device to lubricate a proper quantity of grease into all major chassis parts (except propeller shaft) automatically at regular interval of time through an exclusive lubrication pipe with a control unit during driving.

Inspecting & Replenishing Grease

Pour grease to the MAX remarked on the reservoir tank.

- Inspect or add grease every 2 months
- Recommended grease: NGL 100,000

CAUTION

- When the grease is poured into the reservoir tank it must be a pure thing.
- Replenish grease through the exclusive lubrication inlet to avoid entering foreign material.

NOTE

Lubricate manually with pressing the manual lubrication switch beside the timer as required especially in rainy time or after washing a vehicle. Lubricating interval has specified 6 hour when the vehicle is delivered. Do not necessary to adjust again.

CLS Inspection

- Pour grease into the reservoir tank. Turn the ignition key to the ON position and push the manual button.
- Check the operating condition of the pump. If it is normal open a plug on the end of the fractionator. The pump should be operated continuously until the grease is flowed.
- Turn the main switch off after bleeding air completely from the main pipe and then lock the plug.

- Turn the battery switch on for 15 seconds and off for 5 repeatedly and then check whether the grease lubricates.
- Check the indicator lamp is off when the pump is operated.

CAUTION

Do this procedure once a day before driving.

NOTE

- The auto grease indicator light is turned on at the same time with operation of the pump, and after 3 seconds the light is off. The pump is operated for 154 seconds at one time.
- If the auto grease indicator light is illuminated continuously even after 3 seconds there is a malfunction in the CSL. Have the CLS inspected and repaired by an authorized JAC dealer.

CAUTION

- Turn the main switch off after having the pump worked for 154 seconds although the lamp is off after 3 seconds normally.
- Inspect the tightening condition of leak age of the conjunction part and grease line.

Management of CLS

- Check that there is the grease lubricated at a necessary part around the refueling hole and leaking grease at connecting part of the lubricator and fractionator, periodically.
- Wash the grease container with benzene or mineral oil. Never use trichloroethelene or equivalent solvent.
- Maintain the main switch is OFF when the vehicle is not working for a long time.
- If you work the CLS when the tank is empty, it may be damaged. Inspect frequently.

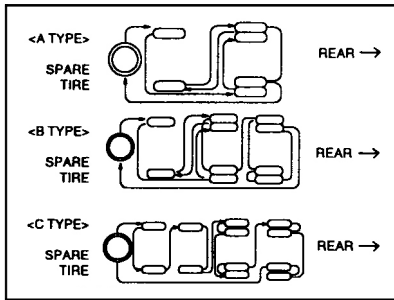

TIRE ROTATION

Tires should be rotated every 8,000 km (5,000miles). If you notice that tires are wearing unevenly between rotations, have the car checked by a JAC dealer so the cause may be corrected.

After rotating, adjust the tire pressure and be sure to check wheel nut tightness.

NOTE:

- Do not mix bias-ply and radial-ply under any circumstances.
- In ace double rear wheel, the difference of outer diameter between outer wheel and inner wheel is less than 12mm.

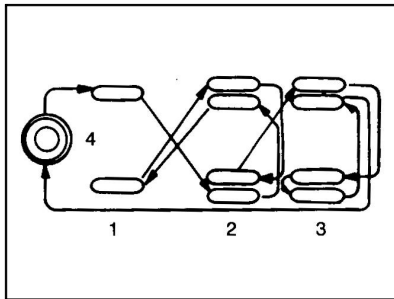

DOUBLE REAR AXLE

1. Front tire
 2. Rear front tire
 3. Rear reartire
- Spare tire

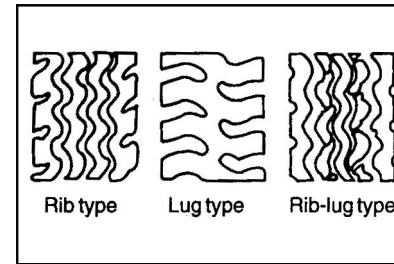

PRECAUTIONS BEFORE HIGH SPEED OPERATION

The higher the vehicle speed, the more heat the tires generate, and eventually there is a danger or a burst.

The heat generated by the tires varies greatly with the tire pattern, tire inflation pressure, load and speed. Pay attention to the following points.

- Keep the tires inflated at normal pressure.
- Avoid overloading.

The lug type pattern tires are not suited for high speed operation, as they tend to skid. If your vehicle is equipped with the lug type tires, care should be taken not to operate it at very high speed.

Exercise special care when controlling the steering wheel or applying brakes on a wet road surface.

TROUBLESHOOTING

Refer to the following causes when the vehicle fails, and take the corrective action as soon as possible. If the causes can not be founded out, have the vehicle checked and repaired by an authorized dealer.

When the starter switch is in 'S' position, engine doesn't start.
 Starter does not rotate at all or rotates slowly.

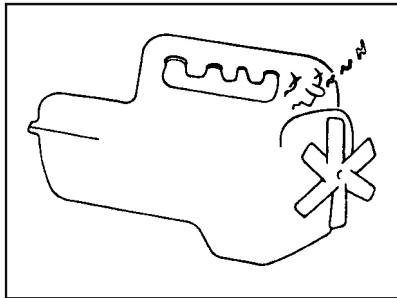

CAUSE	ACTION
Battery discharged	Recharge or replace
Battery terminal disconnected, loosened or corroded	Secure terminal and clean corroded portion
Engine oil viscosity too high	Replace with oil or proper viscosity

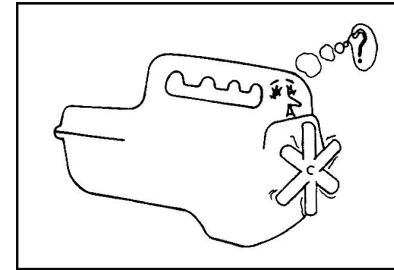

Engine stalls when speed is reduced

Engine too cold	Close radiator cover
Air cleaner clogged	Clean or replace element
Idling speed low	Adjust with engine control button

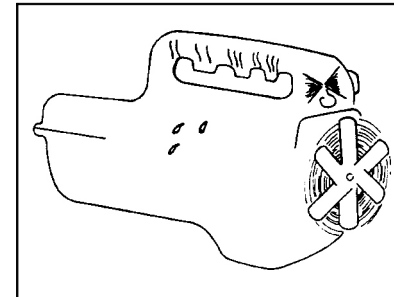

Engine overheating

Radiator cover closed	Open cover
Coolant level low	Add coolant and check for leaks
Radiator front surface contaminated	Clean
Fan belt loose or broken	Adjust tension or replace
Rust or scale in radiator	Clean radiator or replace coolant

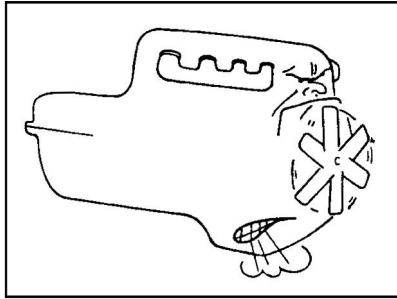

Starter rotates but engine does not start

Air heater circuit fuse blown-out	Replace fuse
Insufficient pre-heating	Preheat fully
Fuel short	Refill
Air cleaner clogged	Clean or replace element
Air in fuel system	Bleed

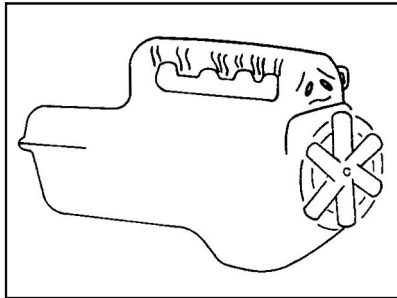

Low torque

Parking brakes applied	Releases all the way
Air cleaner clogged	Clean or replace element



poor exhaust emissions

Air cleaner clogged	Clean or replace element
---------------------	--------------------------

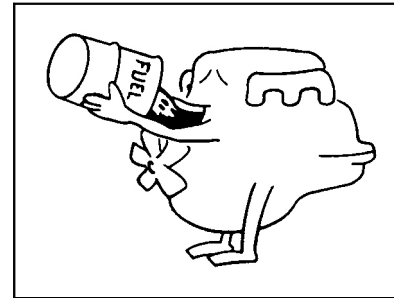

Excessive fuel consumption

Fuel leaks	Correct leaks
Low tire inflation pressure	Adjust tire inflation pressure
Engine too cold	Close radiator cover
Air cleaner clogged	Clean or replace element

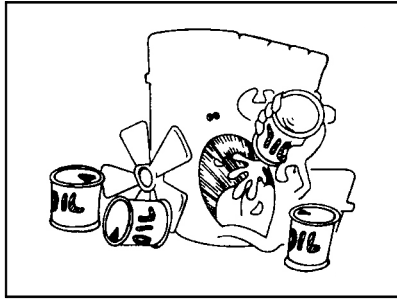

Excessive engine oil consumption

Oil level high	Adjust to specified level
Oil leaks	Correct leaks
Warm-up neglected	Be sure to warm-up

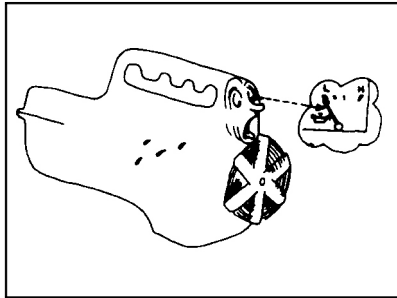

Engine oil pressure does not rise

Low oil level	Adjust to specified level
---------------	---------------------------

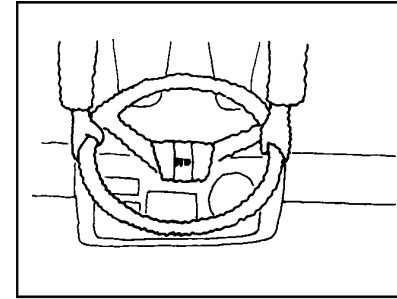

Steering wheel and vehicle make abnormal vibration

Tires unevenly inflated	Adjust to specified inflation pressures
Tires unevenly worn	Replace
Wheel nuts loose	Tighten to specifications

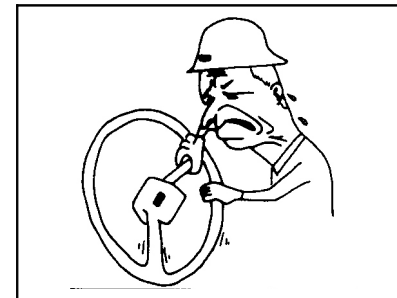

Hard steering

Front tires under-inflated	Adjust to specified inflation pressures
----------------------------	---

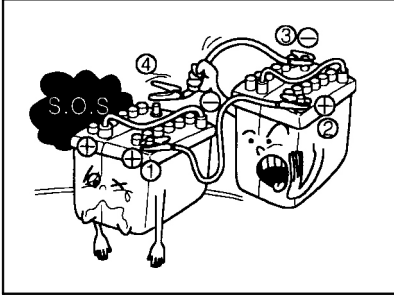

Run-down battery

Lamps or switches left ON	Turn off all unnecessary switches
Battery terminal disconnected, loose or corroded	Reconnect terminal securely and clean corroded portions
Low battery fluid level	Add
Fan belt loose or broken	Adjust tension or replace belt
Battery out of life	Replace

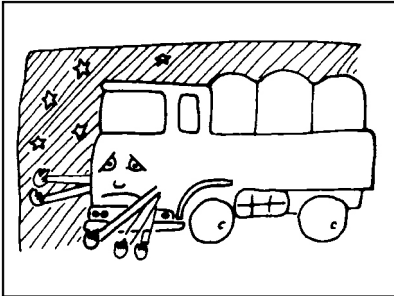

Lamps do not light

Fuse blow	Replace
Bulb defective	Replace

DUMP TRUCK

BEFORE DRIVING

Before driving your tipper, the following information is important for proper care and economical operation and long service life of your JAC tipper.

1. Check if the oil in the hydraulic oil tank is sufficient.

The hydraulic oil is regulated as follows: in winter in the northern areas it is mobile oil No.3 or YC-N46D hydraulic oil, low freezing; in the middle and southern areas of China it is mobile oil No.2 mixed with 30% of machine oil or YB-N45 antiwear hydraulic oil.

2. Check if the operational valve leaks air and if the air roads and oil roads leak when the air pressure is not lower than 0.78Mpa.
3. Check the lifting structure and observe whether the main parts such as hydraulic cylinder, gear pump, operational valve, etc. function normally and whether there are problems such as binding, jumping, sliding, abnormal voice etc. when the dump truck are unloaded
4. Check whether the locking system of the back carriage functions normally in the process of lifting.
5. Check whether it has all the tools and technical documents.

RUNNING-IN OF NEW DUMP TRUCK

1. The running-in period of the dump truck is measured according to the numbers of the lifting of the carriage. Every 1000 times of lifting is counted as one running-in period.
2. In the running-in periods, the load must be controlled. It is regulated as follows:
 - Within 100 times, it is better not to load the dump truck or load it with a small volume of cargos.
 - 100-300 times, the load shall be not larger than 50% of the rating load.
 - 300-600 times, the load shall be not larger than 65% of the rating load.
 - 600-1000 times, the load shall be not larger than 80% of the rating load
3. After 100 times of lifting of the carriage, the hydraulic oil should be completely changed.
4. In the running-in periods, every 50 times of lifting or every one week the lubrication point should be lubricated at least once.
5. In the running-in periods, check condition of the bracket bolt, U type bolt and other linking bolts of the hydraulic cylinder.

WORKING PRINCIPLE AND OPERATION INSTRUCTIONS OF HYDRA-ULIC DUMPING MECHANISM

The dump trucks produced in our company have different control methods: air-controlled, electricity-controlled, controlled by electricity and hydraulic system, and controlled by electricity and air. Before operating the vehicle that you choose, you have to fully understand its dumping control system and master its control method.

Working Principle and Operation Instructions of Air-controlled Dumping Mechanism

1. Working principle (see Diagram 1)

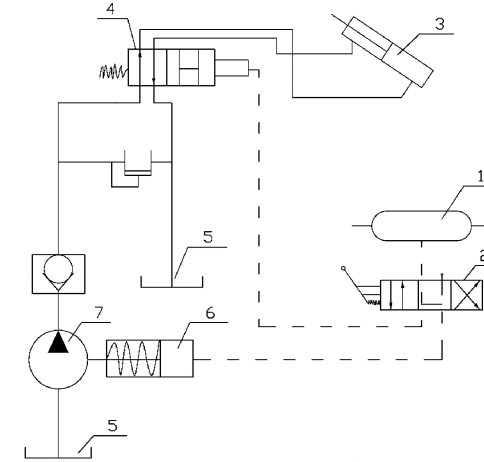

- 1. Air chamber 2. Pneumatic control valve 3. Hydraulic cylinder 4. Turning valve
- 5. Fuel tank 6. Cylinder of the power take 7. Gear pump (with an inverted valve)

--- Gas path — Oil circuit

Diagram 1

When the control handle is pushed to the "lift" position, the compressed air in the reservoir will flow to the power take-off cylinder, thus push the power take-off gear and make the gear pump start to work. Have been pressed by the gear pump, the hydraulic fluid in the fuel tank will flow into the lower chamber of the hydraulic cylinder through the single check valve and the selector valve to push the piston rod and lift the carriage via the connecting rod.

When the piston of the hydraulic cylinder reaches the oil drain hole, the high-pressure oil will flow back into the fuel tank through the oil drain hole and the pipe. Meanwhile, the carriage will stop lifting and maintain the maximum lifting angle.

When the control handle is pushed to the "fall" position, the compressed air in the reservoir will flow to the selector valve and keep it in the open state. At that time, the upper and lower chamber of the hydraulic cylinder is interlinked with the fuel tank, and the carriage's weight will force the oil in the lower chamber of the hydraulic cylinder to flow through the selector valve and flow back into the fuel tank, thus enable the carriage to fall down. When the control handle is at the "pause" position, the selector valve is closed. The gear pump will stop working and the oil in the lower chamber of the hydraulic cylinder will be sealed, enabling the carriage to stop at any position during the process of lifting or falling.

2. Operation Instructions

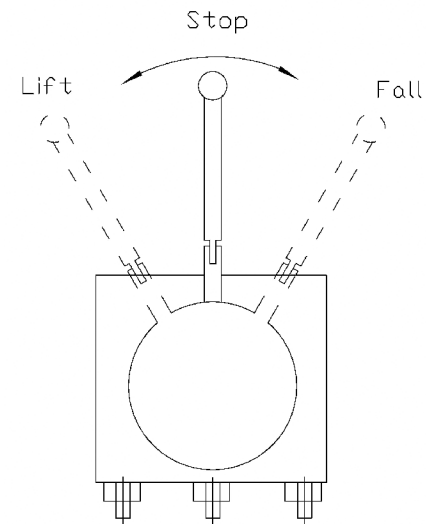

Pneumatic control valve
Diagram 2

The position of the handle
(from left to right): Lift→Pause→Fall

- **Switching on the gear pump**
Press the clutch pedal and push the control handle to the "lift" position. Release the clutch pedal smoothly and the gear pump will start working.
- **Carriage lift**
After the gear pump is started, the carriage begins rising. Increase the throttle and the lifting will be faster. The increase of the throttle is not permitted when the carriage is lifted to the maximum lifting angle. Otherwise, the cylinders and other tilting mechanisms will be damaged.
- **Carriage fall**
Press the clutch pedal and push the control handle to the "fall" position, the carriage will start to fall. When the carriage is back at its original place, push the control handle to "pause" so as to avoid the accidental lifting of the carriage.
- **Pause control**
 1. During the process of carriage lift, press the clutch pedal and push the control handle to "pause"
 2. During the process of carriage fall, push the control handle to "pause".

Note: The operation of lifting after pausing is the same as "Switching on the gear pump" and "Carriage lift". As for the operation of falling after pausing, you only need to push the control handle to "fall".

Working Principle and Operation Instructions of Dumping Mechanism controlled by Electricity and Hydraulic System

1. Working principle (see Diagram 3)

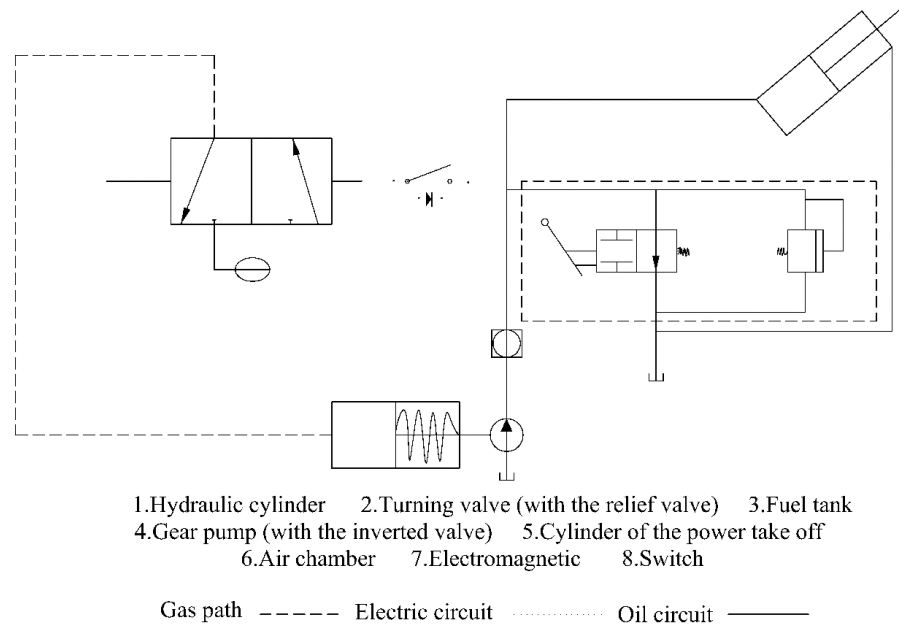

Diagram 3

When the control handle is pushed to the "lift" position and the switch is switched on, the electromagnetic priority valve will be opened. The compressed air in the reservoir will flow to the power take-off cylinder, thus push the power take-off gear and make the gear pump start to work. Being pressed by the gear pump, the hydraulic fluid in the fuel tank will flow into the lower chamber of the hydraulic cylinder through the single check valve, push the piston rod and lift the carriage via the connecting rod.

When the piston of the hydraulic cylinder reaches the oil drain hole, the high-pressure oil will flow back into the fuel tank through the oil drain hole and the pipe. At the same time, the carriage will stop lifting and maintain the maximum lifting angle.

When the control handle is pushed to "fall", the control valve is opened and the lower chamber of the hydraulic cylinder is interlinked with the fuel tank. The carriage's weight will force the hydraulic fluid in the lower chamber of the hydraulic cylinder, through the control valve, back into the fuel tank, thus enable the carriage to fall smoothly. At the same time, the gear pump is still working, and the high-pressure oil is flowing back into the fuel tank through the single check valve and the control valve.

Turn off the switch and the gear pump will stop. Push the control handle to the "lift" position and the oil in the lower chamber of the hydraulic cylinder will be sealed, and enable the carriage to stop at any position during the process of lifting or falling.

2. Operation Instructions

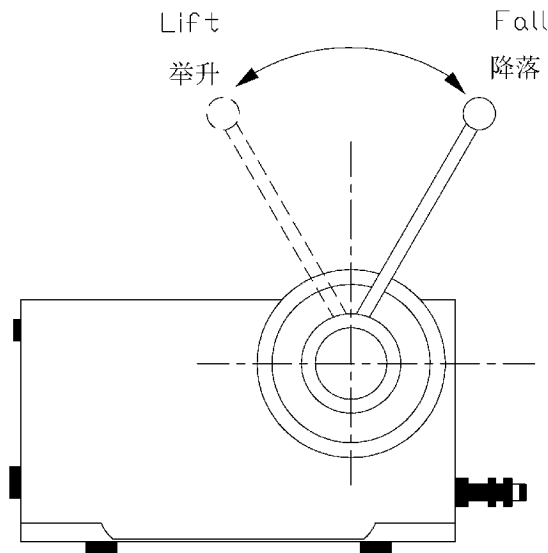

Hydraulic Control Valve
Diagram 4

The position of the handle(from left to right): Lift→Fall

- Switching on the gear pump

Press the clutch pedal and turn the switch to the "on" position. Then release the clutch pedal smoothly and the gear pump will start working.

- Carriage lift

After the gear pump is started, push the control handle to "lift" and the carriage begins rising at an uniform speed. Increase the throttle and the lifting will be faster. The increase of the throttle is not permitted when the carriage is lifted to the maximum lifting angle.

- Carriage fall

Press the clutch pedal; turn off the switch; push the control handle to the "fall" position, then the carriage will start to fall. The speed of falling can be regulated by the opening degree of the control valve.

- Pause control

If you want to stop the carriage during the process of lifting, you only need to press the clutch pedal. Meanwhile, the control valve is still on the "lift" position. But if the pause will last for a long time, you need to turn off the switch. If you want to stop the carriage during the process of carriage fall, push the control handle from "fall" to "lift".

Note: If you want to resume the lifting after pausing, release the clutch pedal and turn off the switch.

If you want to resume the falling after pausing, push the control handle to "fall".

Special notes:

Before starting driving, make sure that the control handle is on the "fall" position so as to avoid the accidental carriage lifting when the car is moving. The power take-off also needs to be switched off. Otherwise, the gear pump will continue working, which will result in the excessive wearing and early damage of the pump.

Working Principle and Operation Instructions of Electricity-controlled Dumping Mechanism

1. Working principle of the hydraulic system

- ◆ The working principle of power take-off control system (see Diagram 5)

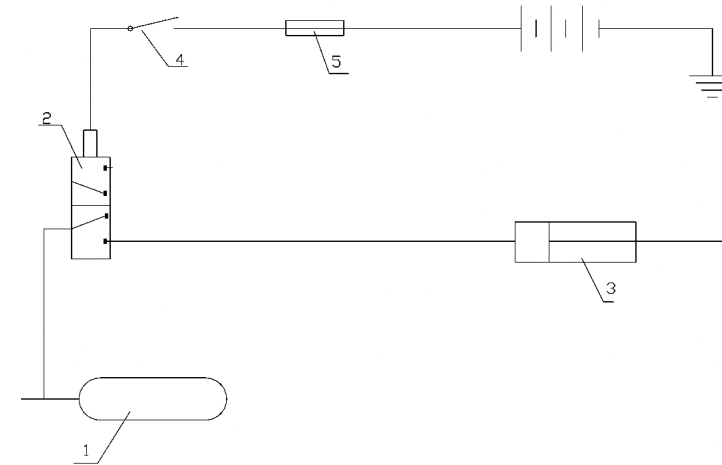

1.Air chamber 2.Electromagnetic air vavle 3.Cylinder of the power take off
4.Double-hole switch 5.Safety device

Diagram 5

Diagram 5 illustrates the working principle of power take-off control system. When the switch is turned on, the compressed air in the reservoir will flow to the power take-off cylinder through the electromagnetic valve, which will push the gear of the power take-off to mesh with the gear of the transmission. When the power is turned off, the air in the cylinder, under the influence of the return spring of the power take-off cylinder, will be discharged into the environment through the vent of electromagnetic valve. The gear of the power take-off will be separated from that of the transmission, cutting off the power of the pump.

◆ The hydraulic principle diagram of dumping system

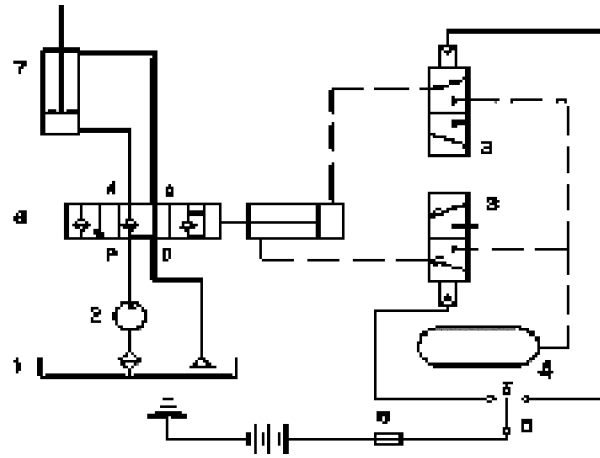

1. hydraulic oil tank
2. gear pump
3. electromagnetic gas valve
4. air tank
5. 3-gang switch
6. air slide valve
7. hydraulic oil tub
8. the fuse

Diagram 6 shows the hydraulic principle of the dumping system. From it we can see that the carriages in the system can pause or fall down, free of the influences of the oil pump's working conditions. Namely, as the carriages are being paused or falling, the oil pump can still be at work. The simplification of the operation in the pausing condition is achievable. The air slide valve, numbered 6, which is factually a 5/4 way air control valve, helps lift, pause or drop the carriages by means of the switch (numbered 5). When the air control valve is on the left, the hydraulic oil flows through the oil tank (1), the gear pump (2), and "P" & "A": the entrances to the air control valve fall down towards the bottom of the oil tub, the carriages are lifted. The oil on the upper part of the tub, however, retreats to the tank by way of "B" & "O". In the case where the air control valve is in the middle (as is signified in the diagram), the line along which the hydraulic oil finally returns to the tank consists of the tank, the bump gear and entrances "P" & "O"; now the carriages are paused. On the right as the air control valve is (the carriages having been raised), part of the oil, due to the gravity of the carriages, comes back through entrances "A" & "O" to the tank; still a certain amount of the oil goes back, passing the tank, the bump gear and entrances P&O. Meanwhile, the downward movement of the tank's piston renders the upper part of the tank vacuum. Some oil, under this situation, enters the upper part of the tank through entrance B.

2. The operational methods

◆ The PTO (Power Take Off) System

Get the engine started and make sure if it is at usual work; remember not to invigorate the gearlever. The moment the air pressure gauge tells that the air pressure of the brake system exceeds 0.4Mpa, separate the clutch, and then, a few seconds after the power is cut off, give a press to the button, which serves as the self-lock switch of the PTO, to turn it on. Afterwards, slowly put through the clutch. With all of the above-mentioned procedures done, the oil pump, driven by the PTO output shaft, is set in motion. To remove it out of work, just separate the clutch and press the button to turn off the PTO.

◆ The Lifting of the Carriages

With the oil pump at work, press the self-lock switch button for lifting and transfer the handle from "O" to "lifting", the carriages are so raised. When they reach the most possible height, the lifting itself is no longer under way, because of the automatic oil spill of the system. The speed of the lifting, though, is in direct proportion with that of the engine's rotating. What should be heeded is that it is inadvisable for the carriages to be lifted too fast. Mostly, for the lifting, the engine needs to be set under the condition of medium accelerograph, and the engine's rotating speed should be kept below the maximum, in case the oil pump should rotate over fast, thus bringing about self-damage.

◆ Bringing -down and Relocating the Carriages

As soon as the carriages are unloaded, the quicker they are brought down the better they are relocated. Press the self-lock switch button for lifting, turn the handles from "lifting", past "O", to "bringing down", then the carriages go into gradual falling until the final relocation comes. Now, again press the button and maintain the handles of lifting and TPO at "O";

the vehicle gets started without delay; and the accidental lifting of carriages is simply out of question.

◆ The Pausing of the Carriages

Suppose you want them to stop at a certain angle (0~48°) when they are being lifted or brought down, what you need to do is merely to turn the lifting switch to "O". A momentary pause does not claim the cut-off of the PTO power, which diminishes the degree of the operational complication. Long-time pausing, however, asks for the cut-off of the power; such being the case, the pump quits working. Therefore, improper operating which harbors accidents is hampered and the amount of unnecessary oil-consuming finds itself reduced.

Notice: You ought to bear in mind that the controlling switch of TPO complies with electricity-liquid circuit and that of the lifting electricity-gas-liquid circuit. So, when it comes to operating, the voltage of the battery must stay at no less than 24V and the air pressure of the gas container at no less than 0.4Mpa. Otherwise, neither the solenoid valve nor the air slide valve would work as usual. Worse still, the valve core being closed is not tight enough, it occurs that the carriages refuse to be lifted and paused in a steady way.

The Working Principle and Operational Instructions of the Dumping Mechanism Controlled by Combinative Electricity-Gas

1. The Working Principles of the Hydraulic System

◆ Principle of the power take off system

For the knowledge of the principles of the PTO system, check it back in(iii)1、(1)

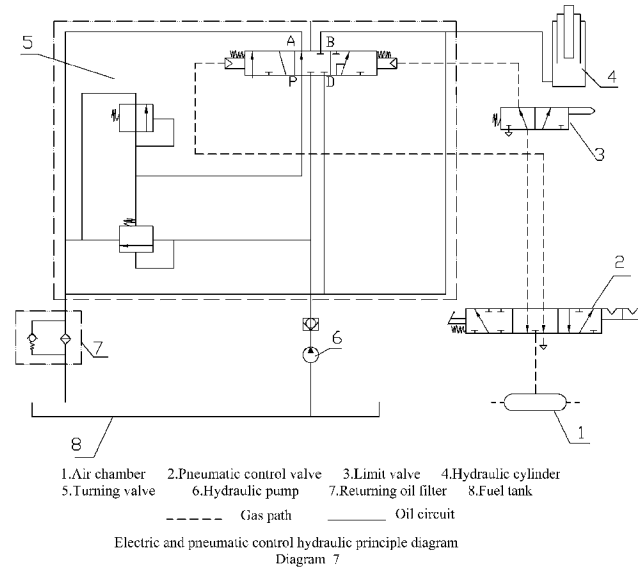

◆ The Hydraulic Principle Diagram of the Dumping System(see Diagram 7)

From the diagram, you can grab the idea that, in the system, the pausing and falling of the carriages are independent of the working condition of the oil dump. In other words, while the carriages are being paused or brought down, the working of the oil pump still continues, so that the operation of the mid-parking procedure is simplified. Valve (1) is an air valve; it relies on the manipulation of valve (2) to direct the high pressure gas, and furthermore, to control the lifting valve, for the sake of steering the carriages freely. When the carriages reach a certain height, some part of them push open the limit valve, and the air path gets cut through. Here comes the right occasion to unload the carriages. As for the hydraulic lifting valve, it functions like this: as valve (1) is on the right, the hydraulic oil, pressurized by the pump, passes through entrances "P" & "A" down towards the bottom of the tub. At this moment, the carriages are on the lift. In the middle as the valve is, two kinds of situation account for the pause of the carriages. Firstly, the pressurized hydraulic oil, past the check valve and the dumping valve, returns to the tank; or, with the PTO turned off, the oil pump quits working. The other kind of condition should be the one in which the hydraulic oil in the tub is blocked. Likewise, two kinds of reasons are sound for the falling of the carriages. Of them, the first one shares the same nature as the first one just above-mentioned; and another should be the fact that the oil in the hydraulic tub, by way of entrances "B" & "A", finally retires in the tank.

2. The Operational Instructions

- ◆ The PTO System(as for its operational instructions, see (iii)2、(1))
- ◆ The Lifting of the Carriages

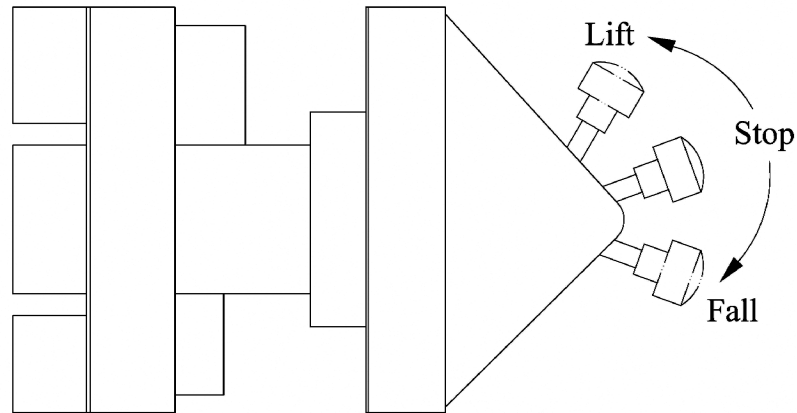

Pneumatic vavle
Diagram 8

As the PTO is on, switch the handle of the air control valve to its "lifting" position, and the carriages automatically rise, upwards till the pre-designated height. At this instant, the limit valve opens itself, the oil becomes released, and the lifting itself is over. The lifting pace of the carriages walks together with that of the engine's rotating. If you use the mid-carriages to do the lifting, you had better not operate them in a hasty way. Normally, in lifting, the engine should be set in the medium accelerator and rotate within the maximum speed; otherwise, the oil pump is likely to be damaged.

◆ Bringing down and Replacing the Carriages

Switch the handle of the air control valve to its "bringing down" position, and the carriages, thanks to the help of their own gravity, will fall down back into the total replacement. Now, the handle should be placed at "pause", so as to prevent the carriages, in moving, from being accidentally lifted. The area the handle you switch around covers, in a sense, commands the falling pace.

◆ The Pausing of the Carriages

When the carriages are being lifted, release the handle and it will come back to the "pausing" position itself; yet if they are falling, you have to turn the handle yourself. The carriages thus stop at their current places in either case.

The Working Principle and Operational Instructions of the Double Cylinder Side Dump

Its principle is demonstrated by Diagram 9 and its operational instruction can be referred to in (iii),

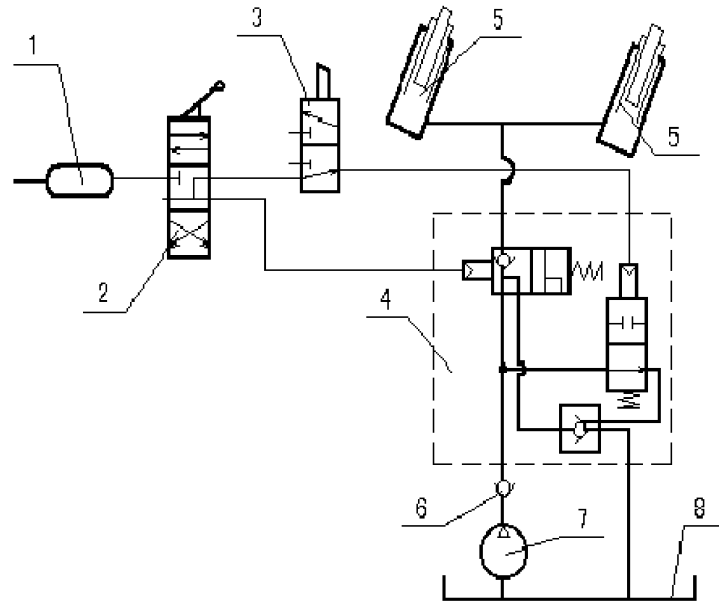

1. air tank
2. air control valve KQF34-B
3. Position control air valve XQF23
4. air control distributing valve
5. hydraulic oil tank
6. check valve
7. oil pump
8. oil tank

1. Lift the carriages

If you want to lift the carriages, just turn the air control valve (2) to the position proper for "lifting", afterwards, the pressurized oil, past the multi-functional distribution valve (numbered 4) straight into the bottom of every oil tub, and now, it's available to do the lifting.

2. The Pausing

At the "pause" position as the air control valve is, it does not matter either the carriages are moving upwards or downwards, the pressurized oil, through distribution valve 4, will thus circulate for the dumping. It turns out that the output of the pressurized oil would cease, and the non-return valve, set in the distribution valve, is forced to be closed, under the effect of the oil pressure prevailing the tubs' bottom parts. Since there is no way for the oil to flow back, the carriages have to stop at a certain place.

3. The Falling

Switch the air control valve to the "falling" part; then the hydraulic oil, with the help of the carriages' gravity, retreat to the tank by way of the distribution valve. The carriages then begin to move downwards.

4. The Fixing of the Carriages

In the procedure of their rising, a pre-designated height is there for the carriages to push open the distribution valve 3. And the pressurized oil find their way through the non-return valve back into the tank, the carriages hereafter stop the motion.

5. Safe pressure regulation

The pressure of the multi-functional distributing valve is regulated when delivered. If the customers have special de-

mands, it can be regulated accordingly. But this must be done with the consultation of the factory. If not, the factory will not be responsible for any possible problems.

Note: The operation of power take-off on the dump truck installed with gearbox, like Shanxi Fuller transmission:

Turning on of the power take-off

Only when the truck is in the low gear (1-4gear) will power take-off be used. The procedure of turning on the PTO is as follows:

- Step down the clutch pedal;
- Turn on the neutral gear and the power take-off in turn;
- Shift gear, and release the clutch, then the power take-off will be turned on and the dumping indicator on the dashboard will shine. (Only when the truck is in gear can the power take-off function.)

Turning off of the power take-off:

- Step down the clutch pedal;
- Shift the gear lever to the neutral position;
- Turn the PTO and neutral gear on the dumping control structure to the "off " position, release the clutch, then the PTO will be turned off and the dumping indicator on the dashboard will go out. The driving power train is connected now.

TIPS OF USAGE

1. Check before driving the handle of the operational valve and the switch of the power take-off, and make sure they are on the "pause" position. Make sure the gear pump is not at work, lest the carriage will lift automatically on the way and cause unnecessary losses.
2. To make the gear pump work in the process of lifting or landing, step down the clutch pedal first. Otherwise, it will cause serious wear to or break the PTO gears when they joggle.
3. When the dump truck are fully loaded, check whether the manual handle, hook and other parts are open so as to make sure the door can be opened normally in the process of lifting, in case there are large accidents such as the turnover of the truck.
4. During the lifting of the carriage, the engine speed should not exceed 2400r/min as to avoid the damage of the oil pump when it exceeds the speed limit or the turnover of the carriage because of the imbalance caused by quick lifting. When it is lifted nearly to the biggest angle, do not accelerate, or the carriage may be over lifted, which will further cause the back carriage to hit the ground and be distorted, the big carriage to turn over and be damaged, and other damage to other parts in charge of lifting.
5. When the dump truck are loaded by other machines, make sure the machine pours the cargo into the carriage in a low position. Otherwise the strong bump will cause damage and distortion to the bottom board or even the girder of the main machine and other parts.
6. Check consistently whether there is leakage of the dumping system. When filling into the tank the hydraulic oil, check whether the filter mesh at the mouth of the tank is damaged, and change it when necessary. Otherwise the impu-

rity will go into the tank and cause damage to the hydraulic components. Do not fill the tank with the mixture of different brands and types of hydraulic oil or the oil which is on the instructions.

7. Always check the engagement condition of power take-off and gear pump to avoid the accidental lifting of the carriage caused by incomplete separation of the gears. Besides, pay attention to the unusual phenomena such as the abnormal voice and overheat under the working condition in order to expel them in time. Or they will cause earlier damage to the power take-off, gear pump, valves and other parts.

8. Always pay attention to the condition of the hydraulic cylinder and other parts when lifting. There should not be phenomena like binding, sliding, jumping or abnormal sounds. These abnormal phenomena should be fixed in time to avoid the earlier damage to the oil tank.

9. Always check whether the locking structure of the back carriage is in good condition, and make sure it is in the right angle capable of automatic open and close to avoid the trouble or accidents caused by the accidental open of the back carriage or when it doesn't open during lifting. When dumping large rocks, heavy lumps or other similar objects, remove the back carriage to avoid damage to it.

10. During maintenance, pay attention to the working planes of the hydraulic cylinder and the gear pump to see whether there are bruises and scores, because they will damage the function of the hydraulic cylinder.

11. Pay attention to the solitariness in maintenance, in case that the impurity such as silt and thread residue will infiltrate into the hydraulic system to pull the components and block the valves and finally damage the working function.

12. If the tipper has not been used for a long time, it must be inspected following the inspection contents for the new one and then can be reused.

13. You should inspect the conditions of such parts as the carriage, second frame and spare wheel frame, and deal with such problems as loosening and sealing off to avoid serious accidents.

14. You should examine whether the main frame and second frame are connected firmly, whether U wire and iron are loose, whether the punch is padded, the cushion and rubber cushion block are fixed, and if they are loose or in version, you must fasten them and put them the right place and cannot transport goods and unload them, for the frame, the secondary frame and lift system will be deformed or damaged, the tipper will even be turned over, which will threaten safety of life and property.

15. Loading, transportation and unloading

- The goods should be distributed evenly and can not run over the carriage itself, and their density should not be over 1600Kg/m³ with their rest angle be smaller than 45 centigrade;

- The fully loaded vehicle should be driven at an appropriate speed according to road condition. When it is inclined in bad road, it can only be moved on the condition that the goods have been discharged. They can be taken out by manual labor from the carriage (if the carriage is mobile, they can be taken out from the side door) and cannot be taken out by lifting system.

16. Important suggestion: in any of the following conditions, the vehicle will possibly be damaged and accident will take place. Please pay special attention to them and do not operate in the situations A-I (altogether 9 kinds).

A. Running or lifting them when goods are being loaded will:

- make both the vehicle and man in insecure situation
- shorten the service life of the vehicle
- damage in the earlier period the refitted part

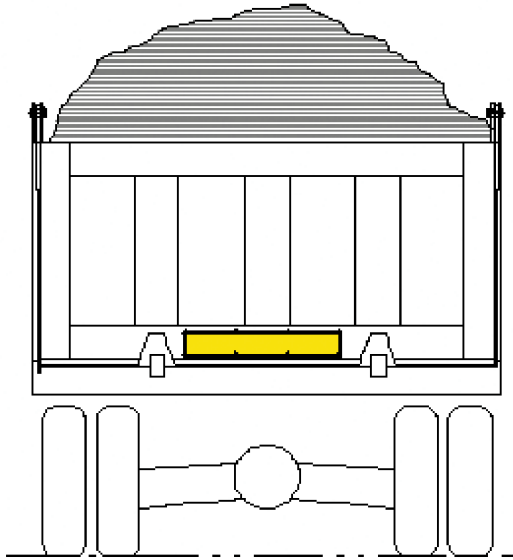

B. Running or lifting them when the goods are unevenly loaded will

- make the vehicle turn over
- make the tire burst and the carriage and frame deform
- distort and damage lift system and make the vehicle prone to accidents

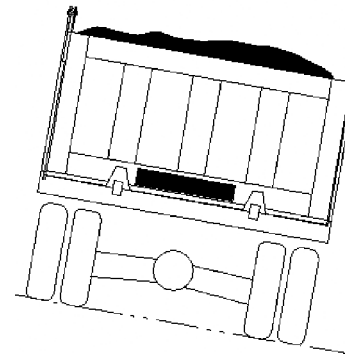
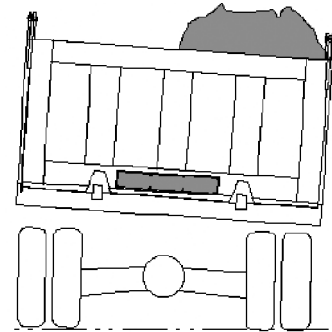

C. Unloading the goods on a slope with an angle of over 5 degrees or on soft ground will:

- make the vehicle turn over easily and lead to death and loss of property
- deform or damage easily the lift system

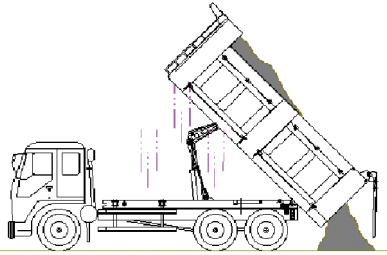

D. Lowering the carriage fall suddenly when the goods have not still been unloaded will

- distort or destruct the lift system
- deform the frame and chassis, make the tire burst and even lead to other serious accidents

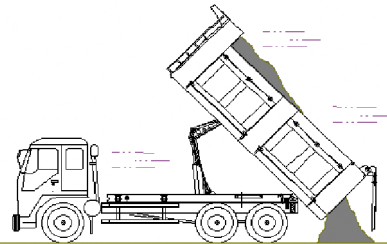

E. Driving the vehicle forward when the goods are unloaded partially will:

- make the vehicle out of control, front wheels off ground and the tipper turn over etc because of high gravitational center
- distort or damage lift system, frame and back hinge point because of high gravitational center

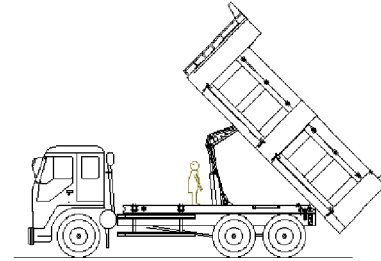

F. If man remain under the carriage that has not yet been propped or propped firmly,

- his life will be in danger when hydraulic system leaks or control system stops functioning suddenly
- accident will take place if the carriage fall suddenly by other's wrong operation

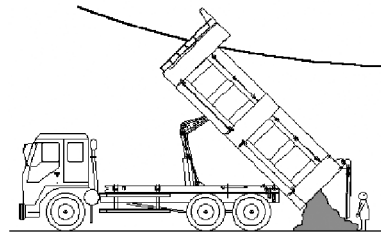

G. If man remains in the working area of the tipper or unload the goods in the place where there are other interferences,

- such accidents as people are injured by carriage and goods, electricity wire cut and carriage or other equipments damaged will be easy to happen

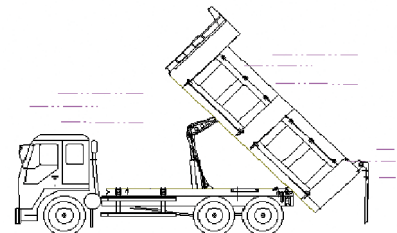

H. If you drive the tipper when the carriage is still being lifted,

- the lift system will be damaged, the carriage crashed, the electricity line cut, other equipment destroyed and even life is in danger

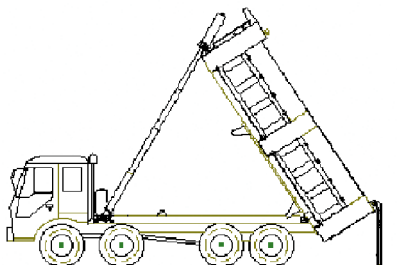

I. If the tipper is lifted out of its limit,

- the carriage will turn over, hydraulic cylinder and other components be damaged, the back carriage crashed and opening destroyed

Special notes

- All the above-mentioned notes apply to all kinds of dump truck produced by our company
- Driving against the rule and disobeying the above notes are regarded as signs of users' giving up the right to be served by us, and all the consequences and responsibilities brought about will be undertaken by users instead of us.

TECHNICAL MAINTENANCE

Regular technical maintenance can help avoid the early abrasion of motion parts, reduce the accident frequency when the vehicle is used and stop some potential accidents, so it is a key point to improving the efficiency and prolong its service life. The details are:

1. The new vehicle should be loaded in strict compliance with the rules in its running-in period;
2. Everyday before and after you drive your vehicle:
 - Inspect the hydraulic oil amount and add more if the oil is inadequate; inspect whether hydraulic system is damaged or leak, and repair it if so:
 - Inspect whether such parts as the top and bottom bolster of the hydraulic cylinder and connecting rod are connected and fixed. Observe whether all the motion parts and their neighboring fixed parts are damaged or deformed;
 - Inspect the condition of the carriage, second frame and spare wheel frame and observe with special attention whether the weld joints are open or cracked; inspect the work or abrasion conditions of gear pump, power take-off and hydraulic cylinder, maintain and repair or replace the damaged parts.
3. Every week or after 50 working hours:
 - Inspect all the gas lines and hydraulic tie-ins leak, if so, replace the damaged hoses;
 - Inspect all the bolts and nuts to see whether they are loose, if so, fasten them;
 - Inspect all kinds of velvets and hydraulic cylinder, and clean them if they are dirty;
 - Inject oil to all the injection locations once to ensure the vehicle can work normally;
 - Inspect the conditions of stow-wood, rubber cushion blocks and rubber cushion belts, and replace them in time if

they are corrupted or aged.

4. The high pressure hoses must be changed every other year, and must be replaced in time if they are damaged or swell partially;
5. The hydraulic oil must be kept clean and can not contain water and impurities; it must be changed regularly and its deposits be cleared; hydraulic oil must deposit 48 hours before injected into oil tank; the filtration accuracy of hydraulic oil should be lesser than 25 μ m.(The oil tank must be cleaned once each week or after 50 hours; the hydraulic oil should be changed once when the carriages have been lifted 600-800 times, and must be changed any time when the oil is dirty or aged; the longest period is one year.)

Attachment: the main lubrication points and their locations of all kinds of dump truck:

A. The lubrication diagram of direct push tipper with front cylinder

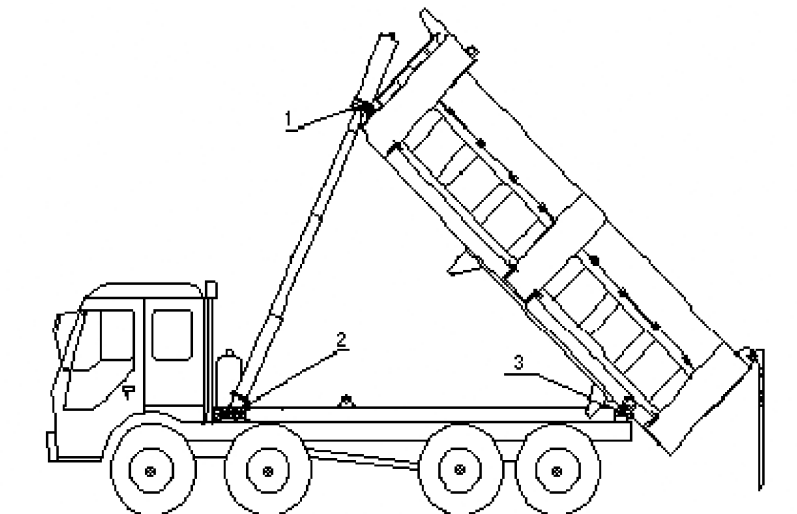

1. the hinge point between cylinder and top frame (two places)
2. the hinge point between cylinder and bottom frame (two places)
3. the hinge point between top frame and bottom frame (two places)

B. The lubrication diagram of composing tipper with cylinder and front push connecting rod

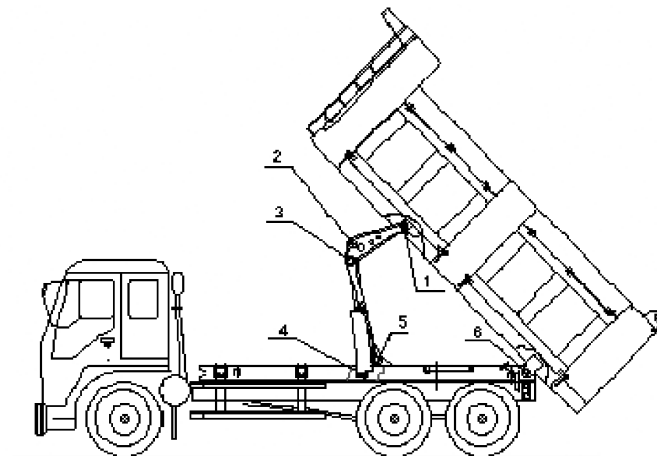

1. the hinge point between arm and top frame (two places)
2. the hinge point between arm and top of lift cylinder (two places)
3. the hinge point between arm and drawbar (two places)
4. the hinge point between lift cylinder and bottom frame (two places)
5. the hinge point between drawbar and bottom frame (two places)
6. the hinge point between top frame and bottom frame (two places)

C. The diagram of composing tipper with floating cylinder and connecting rod

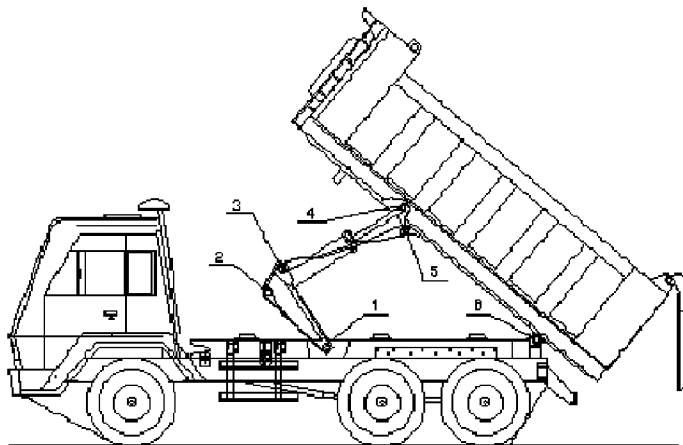

1. the hinge point between arm and bottom frame (two places)
2. the hinge point between arm and bottom of lift cylinder (two places)
3. the hinge point between arm and drawbar (two places)
4. the hinge point between top lift cylinder and top frame (two places)
5. the hinge point between drawbar and top frame (two places)
6. the hinge point between top frame and bottom frame (two places)

D. The lubrication diagram of drop side tipper with double cylinders

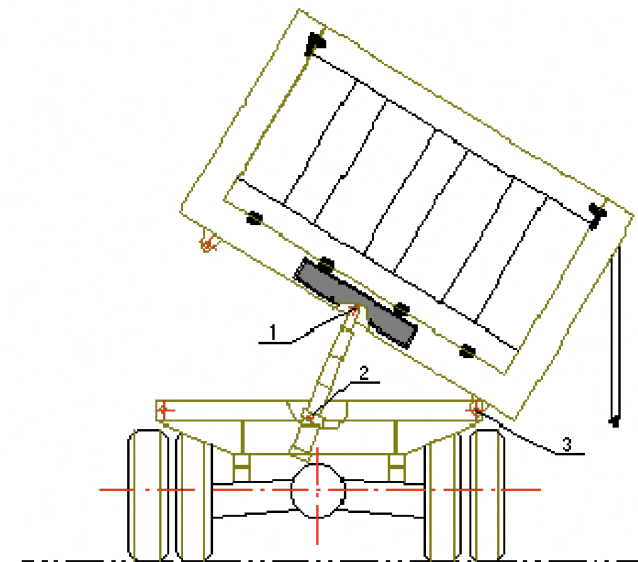

1. the hinge point between top cylinder and carriage (two places)
2. the hinge point between bottom cylinder and secondary frame (two places)
3. the hinge point between carriage and secondary frame (two places)

Notice

- All the lubricate parts mentioned above must adopt auto general lithium grease No.2.
- Don't apply any grease to the surface of lift cylinder or piston lever. Wipe away the stains using dry silk fabric or a towel.

TRANSPORTATION AND STORAGE

1. When transported by railway or water, the tipper should be lifted using lifting equipment, in case of damages to the products.
2. The products should be fastened to ensure security and avoid accidents during the transportation.
3. When the tipper is kept unused for a long time, keep it according to the rules about the cart refitting and chassis maintenance.

TROUBLE SHOOTING:

possible problems	analysis of reasons	solutions
Operational valve is in the lifting position, but the carriage is not.	<ol style="list-style-type: none"> 1.power take-off doesn't joggle 2.insufficient oil amount in the oil tank 3.malfunction of the control system <ul style="list-style-type: none"> ● lack of voltage or obstructed circuit ● lack of air pressure or air leakage ● electromagnetic valve malfunction 4.oil leakage of the hydraulic system 5.too much inner leakage of gear pump 6.directional control valve isn't shut 7.the plug doesn't recover the original position when in the limited valve 8.too much leakage in the oil tank 9.the operational valve doesn't work 	<ol style="list-style-type: none"> 1.solve the gear engagement problems, repair or change the power take-off. 2.put the oil in the tank according to the rules 3.solve the control system problems <ul style="list-style-type: none"> ● fully charge or connect the circuit ● inflate the system or repair the leakage parts. ● repair or change the electromagnetic valve 4.repair the oil leakage parts 5.change the gear pump 6.cheek if the plug is blocked up and adjust it 7.check and adjust the post guide and plug 8.change the gasket set or oil tank 9.repair or change the operational control valve

possible problems	analysis of reasons	solutions
The carriage is not lifted to the proper position or doesn't stop after being lifted	<ol style="list-style-type: none"> 1.shortage of hydraulic oil amount 2.the directional control valve isn't fully shut 3.one-way valve leakage 4.valve moves up and down when in limited valve 5.inner leakage of the gear pump 	<ol style="list-style-type: none"> 1.fill up with the hydraulic oil 2.check, maintain and change for new ones. 3.check and change for new ones. 4.refit the limited valve. 5.change the gear pump.
The carriage moves up and down when lifted or is lifted too slowly	<ol style="list-style-type: none"> 1.air in the hydraulic system 2.the directional control valve isn't fully shut 3.some inner leakage of the gear pump 4.small holes on the oil tank filter are blocked up 5.one-way valve is blocked up 6.shortage of hydraulic oil 	<ol style="list-style-type: none"> 1.re-lift to let out the air 2.adjust the directional control valve 3.change the gear pump 4.check and change the oil filter and the hydraulic oil 5.repair and change the one-way valve 6.fill up with the hydraulic oil

possible problems	analysis of reasons	solutions
The carriage cannot descend	1.binding of the directional control valve plug 2.the directional control valve cannot open the valve 3.leakage of the gas way leading to the descending position of the directional control valve or shortage of air pressure or malfunction of the electric control valve circuit	1.refit the plug and clean the filth 2.repair the air leakage parts 3.check and repair the air way and circuit
The carriage descend automatically or too quickly or too slowly	1.the directional control valve isn't fully shut 2.one-way valve isn't airproof 3.serious inner leakage of the hydraulic cylinder 4.the directional control valve retrieves oil too slowly or too quickly	1.check and change the oil if it's dirty 2.check, repair and change 3.check and repair the gasket sets or change the hydraulic cylinder 4.adjust the oil retrieving speed of the directional control valve
directional control valve leakage	1,the oil jam in the hydraulic oil tank 2,the gasket set wears off 3,the valve fixed bolt loosens	1,change the hydraulic oil and clean the plug 2,change the gasket sets 3,fasten the bolt
hydraulic cylinder leakage	1,oil-proof or gasket set wears away 2,the scrapes on the surface of oil tank	1,change the oil-proof or gasket sets 2,check, repair and change for new ones.

INSTRUCTIONS OF SIDE-DUMP TIPPER

1.Working Principles Graph:

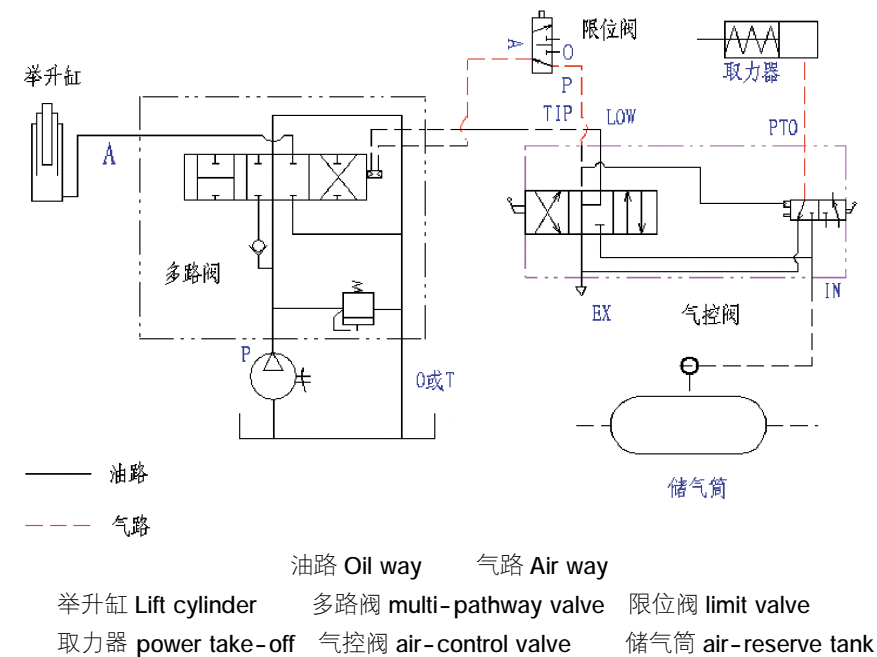

2. Instructions Of Usage:

- After the auto is fully stopped, pull out the right-side cotter pin, take out the right-side dumping pin and open the door manual handle(left-side short lock) ;
- Back on the driving seat, step down the clutch pedal, and shift into the low gear (1st and 2nd gear, similarly hereinafter), open the power take-off at the "on" position, loose the clutch pedal and then the power take-off begins to work.
- Lift up the air control valve handle of the operational oil tank (assembled valve) to the "lift" position, and after the lifting movement, all the goods are downloaded(heavy goods are not allowed to be dumped directly here, otherwise accidents may happen). Then retrieve the handle to the "descend" position. Last, after the carriage goes back in place, shift the handle to the "pause" position, the gear to the "neutral" gear, and put the power take-off control handle to the "off" position.
- Put in the right-side dumping pin and the right-side cotter pin, put back the door manual handle (left-side short lock bar), and only in this way can the tipper drive.

3. Notice:

- Before shifting the power take-off control handle to the "off" position, be sure that the gear is put in the "neutral" position to avoid the moving on of the tipper and possible accidents.
- Before the lifting, be sure to open the left-side short lock bar!!!
- The tipper is forbidden to dump heavy loads in case accidents may happen.
- Please follow the rules mentioned before carefully. The company will not be responsible for the accidents disobeying these rules.

VEHICLE SPECIFICATION

DUMP TRUCK SPECIFICATION

Half Height Roof	Drive mode	HFC3251KR1	HFC3251KR1	HFC3251KR1
Cab, tilt cab	Model	6×4	6×4	6×4
Engine	Model	WD615.46with BOSCH pump	WD615.50	L340 20 (CUMMINS made in China)
	Displacement(cc)	9726	9726	8900
	Max output power (Hp/rpm)	360/2400	290/2200	340/2200
	Max torque (N.m/rpm)	1460/1450	1160/1500	1350/1400
Transmission	Model	9JS150T-B+QH50 US Eaton Technology with synchronizer	RT11509C+QH50\9JS150T-B+QH50 US Eaton Technology	ZF 16S 1650 ZF made in China
	Gear position	8 6 4 2 L 7 5 3 1 R	8 6 4 2 L 7 5 3 1 R	1 3 5 7 R 2 4 6 8
Clutch	Mode	Single, dry plate, diaphragm spring	Single plate,dry,screw spring	SACHS Single plate,dry,diaphragm spring,SACHS made in Germany
Rear Axle	Model	Steyr Technology (5.73)	Steyr Technology(5.73/6.72)	Steyr Technology(4.8)
Main parameter	Overall Dimension (mm)	8960×2560×3330	8265/8355×2495×3500	8265/8355×2495×3500
	Rear cargo dimension (mm)	5660×2300×1350	5400/5600×2300×1500	5400/5600×2300×1500
	Wheel base (mm)	4350+1350	3690+1350	3690+1350
	Tread (mm)	2040/1860	2040/1860	2040/1860
	Suspension arm (mm)	1495/1765	1495/1730,1495/1820	1495/1730,1495/1820
	Curb weight (Kg)	14400	13350/13580	13350/13580
	Rated payload (Kg)	28500	26650/26420	26650/26420
	GVW (Kg)	42900	40000	40000
	Max speed (Km/h)	80	80	80
Radius of turning (m)	10	9	9	
Tire		12.00-20/12.00R20/12.00R22.5	11.00R20/11.00-20, 12.00-20/12.00R20	12.00-20/12.00R20

Half Height Roof	Drive mode	HFC3251KR1	HFC3251KR1	HFC3251KR1
Cab, tilt cab	Model	6×4	6×4	6×4
Engine	Model	ISM440E 20(CUMMINS made in China)	ISME 20(CUMMINS made in China)	WP10.290
	Displacement(cc)	10800	10800	9.726
	Max output power (Hp/rpm)	440/1800	380/1800	290/2200
	Max torque (N.m/rpm)	2100/1200	1825/1200	1160/1200-1600
Transmission	Model	ZF 16S 221 ZF made in Germany	ZF 16S 1950 ZF made in China	RT11509C+QH50 US Eaton Technology
	Gear position	1 3 5 7 R 2 4 6 8	1 3 5 7 R 2 4 6 8	8 6 4 2 L 7 5 3 1 R
Clutch	Mode	SACHS Single plate,dry, diaphragm spring,SACHS made in Germany	SACHS Single plate,dry, diaphragm spring,SACHS made in Germany	Single plate,dry,screw spring
Rear Axle	Model	Steyr Technology (4.8)	Steyr Technology (4.8)	Steyr Technology(5.73/6.72)
Main parameter	Overall Dimension (mm)	9395×2495×3330	8960×2560×3330	8265/8355×2495×3500
	Rear cargo dimension (mm)	/	5660×2300×1350	5400/5600×2300×1500
	Wheel base (mm)	4350+1350	4350+1350	3690+1350
	Tread (mm)	2040/1860	2040/1860	2040/1860
	Suspension arm (mm)	1495/2200	1495/1765	1495/1730,1495/1820
	Curb weight (Kg)	14400	14400	13350/13580
	Rated payload (Kg)	28500	28500	26650/26420
	GVW (Kg)	42900	42900	40000
	Max speed (Km/h)	80	80	80
Radius of turning (m)	10	10	9	
Tire		12.00R22.5	12.00R22.5	11.00R20/11.00-20, 12.00-20/12.00R20

Half Height Roof	Drive mode	HFC3251KR1	HFC3252KR1	HFC3310KR1
Cab, tilt cab	Model	6×4	6×4	8×4
Engine	Model	WP10.290	WP10.336	WD12.336
	Displacement(cc)	9.726	9.726	11596
	Max output power (Hp/rpm)	290/2200	336/2200	336/2200
	Max torque (N.m/rpm)	1160/1200-1600	1250/1200-1600	1300/1400
Transmission	Model	9JS150T-B+QH50 US Eaton Technology with synchronizer	9JS150T-B+QH50 US Eaton Technology with synchronizer	12JS160T+QH50 US Eaton Technology
	Gear position	8 6 4 2 L 7 5 3 1 R	8 6 4 2 L 7 5 3 1 R	12/6 10/4 8/2 11/5 9/3 7/1 R2/R1
Clutch	Mode	Single plate,dry,screw spring	Single plate,dry,screw spring	Single, dry plate, diaphragm spring
Rear Axle	Model	Steyr Technology(5.73/6.72)	Steyr Technology(5.73/6.72)	Steyr Technology(5.73/6.72)
Main parameter	Overall Dimension (mm)	8265/8355×2495×3500	8265/8355×2495×3500	10575/10655*2495*3240
	Rear cargo dimension (mm)	5400/5600×2300×1500	5400/5600×2300×1500	7600/7800*2300*1500
	Wheel base (mm)	3690+1350	3690+1350	1700+3870+1350
	Tread (mm)	2040/1860	2040/1860	2040/1860
	Suspension arm (mm)	1495/1730,1495/1820	1495/1730,1495/1820	1925/1730,1925/1820
	Curb weight (Kg)	13350/13580	13350/13580	19500/19720
	Rated payload (Kg)	26650/26420	26650/26420	30060/30280
	GVW (Kg)	40000	40000	50000
	Max speed (Km/h)	80	80	80
	Radius of turning (m)	9	9	9
Tire		11.00R20/11.00-20、12.00-20/12.00R20	11.00R20/11.00-20、12.00-20/12.00R20	11.00R20/11.00-20、12.00-20/12.00R20

CARGO SPECIFICATION

Half Height Roof	Drive mode	HFC1200KR1	HFC1251KR1	HFC1251KR1
Cab, tilt cab	Model	6*2	6*4	6*4
Engine	Model	CA6DF2-22	WD615.44 with BOSCH pump	6CL280-2
	Displacement(cc)	7127	9726	8270
	Max output power (Hp/rpm)	220/2300	330/2100	280/2200
	Max torque (N.m/rpm)	780/1500	1250/1400	1250/1400
Transmission	Model	F6J95TB	9JS150T-B US Eaton Technology with synchronizer	8JS118TC
	Gear position	5 4 2 6 3 1 R	8 6 4 2 L 7 5 3 1 R	8 6 4 2 7 5 3 1 R
Clutch	Mode	Single plate,dry,screw spring	Single, dry plate, diaphragm spring	Single plate,dry,screw spring
Rear Axle	Model	468 Axle(4.875)	Steyr Technology(4.8/5.73)	457 Axle(4.875)
Main parameter	Overall Dimension (mm)	11990*2495*3220/3530	10990*2495*3220/3530	11990*2495*3220/3530
	Rear cargo dimension (mm)	9500*2340*550/800	8500*2340*550	9500*2340*550/800
	Wheel base (mm)	1700+5300	6000+1350	6000+1350
	Tread (mm)	2040/1840	2040/1860	2040/1860
	Suspension arm (mm)	1925/3065	1495/2145	1495/3145
	Curb weight (Kg)	9500	11700	11700
	Rated payload (Kg)	17000	21300	21300
	GVW (Kg)	26500	34000	34000
	Max speed (Km/h)	90	90	90
Radius of turning (m)	9	11	11	
Tire		11.00-20	12.00-20/12.00R20	11.00-20

Half Height Roof	Drive mode	HFC1251KR1	HFC1312KR1
Cab, tilt cab	Model	6*4	8*4
Engine	Model	CA6DF2-26	CA6DF2-26
	Displacement(cc)	7127	7127
	Max output power (Hp/rpm)	260/2200	260/2200
	Max torque (N.m/rpm)	930/1400	930/1400
Transmission	Model	8JS118TC	8JS118TC
	Gear position	8 6 4 2 7 5 3 1 R	8 6 4 2 7 5 3 1 R
Clutch	Mode	Single plate,dry,screw spring	Single plate,dry,screw spring
Rear Axle	Model	153 Axle(4.875)	457 Axle(4.875)
Main parameter	Overall Dimension (mm)	11990*2495*3220/3530	11990*2495*3220/3530
	Rear cargo dimension (mm)	9500*2340*550/800	9500*2340*550/800
	Wheel base (mm)	6000+1300	1700+4525+1350
	Tread (mm)	2040/1860	2040/1850
	Suspension arm (mm)	1495/3145	1925/2490
	Curb weight (Kg)	11700	13000
	Rated payload (Kg)	21300	31000
	GVW (Kg)	34000	44000
	Max speed (Km/h)	90	90
Radius of turning (m)	11	12	
Tire		11.00-20	11.00-20