



CRAWLER EXCAVATORS

28 – 66 Metric Ton

DX300LC	30 740 kg	67,770 lb.	213 hp (159kw)
DX350LC	35 653 kg	76,601 lb.	281 hp (210 kw)
DX420LC	42 866 kg	94,503 lb.	362 hp (270 kw)
DX490LC	51 030kg	112,502 lb.	389 hp (290 kw)
DX530LC	54 074 kg	119,213 lb.	389 hp (290 kw)



DOOSAN DELIVERS *a heritage of dedication*

DOOSAN, a strong, stable and global company with a 115-year legacy, has a heritage in equipment manufacturing that began in 1937. Since 2005, we've grown to become the fifth largest construction equipment manufacturer in the world.





Doosan can be found in every area of the infrastructure support business, which encompasses many facets of the heavy construction equipment industry.

Many contractors might be surprised to know that, while Doosan is a relatively young brand in the North American construction equipment market, the organization has a global manufacturing history going back more than 75 years.

Today, Doosan Infracore Construction Equipment America (DICEA) and its affiliates are industry leaders in the engineering, manufacturing and marketing of construction equipment including skid-steers, excavators, wheel loaders, articulated dump trucks, attachments, air compressors, lighting systems and generators as well as compact construction equipment and engine power systems.

Building Your Tomorrow Today

Our construction equipment group leads Doosan's infrastructure support business (ISB) segment. Other ISB businesses include:

- Forklifts & Material Handling
- Machine Tools
- Castings & Forgings
- Construction & Engineering
- Power Generation
- Water Treatment & Desalination
- Renewable Energy

Your North American partners.

Throughout our decades of selling equipment in North America, we've been building a network of dealers designed to surpass the standards for customer service. From coast to coast, there's a solid infrastructure that supports your equipment, including a parts distribution facility in Chicago and a service training facility in Georgia, sales training center in Arizona, attachments design and development in Minnesota and sales & marketing support in North Dakota.



West Fargo, ND
Sales & Marketing

Tucson, AZ
Product Training & Testing

Litchfield, MN
Heavy Attachments

Chicago, IL
Parts Distribution

Suwanee, GA
Service Training & Product Management

Atlanta, GA
DICEA, NA Headquarters

DOOSAN DELIVERS *Performance*

Take the controls. For every dollar you spend on your equipment, Doosan gives you more. Powerful hydraulic forces with high horsepower and torque characteristics bring superior production. Low-emission engines utilize high pressure common rail electronic fuel injection for superior top-end performance and a strong low-end torque rise. Powerful arm and bucket forces on our excavators allow you to move dirt with ease. Performance is what it's all about; Doosan delivers what you need and then some.

Arm and Bucket Force

Superior hydraulics deliver ample power to the arm and bucket for digging, loading trucks and more. A one-touch power boost momentarily amplifies your hydraulic power, helping you take on difficult digging conditions that slow other machines down. Add it all up for exceptional productivity.

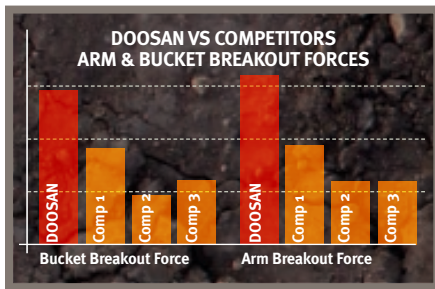

Swing Torque

New Doosan models have an 8-11 percent increase in swing torque that allows the excavator to swing uphill with ease – and improve backfilling performance. That means less excavation time per foot of trench.

Four Power Modes

Selectable power modes give you more control over your excavator's performance. Manage the balance of fuel consumption and machine power to your liking, based on your working conditions.

P+ **Power+ mode** delivers the fastest workgroup speeds to save more time when loading trucks. Top digging performance delivers extra power for digging in hard ground and other tough digging conditions.

P **Power mode** provides excellent power and superior performance for tough digging and heavy lifting. It also provides quick truck loading and fast travel speed to save time.

S **Standard power mode** optimizes your fuel consumption and delivers high performance in everyday digging, grading and lifting.



E **Economy mode** reduces fuel consumption for low-demand applications and slows down machine movement, which is handy for fine digging, light grading conditions and jobsite conditions that require extra precision.

One-Touch Power Boost

The convenient button on the right-hand joystick provides momentary increased hydraulic power to break through hard ground and other tough digging conditions.





DOOSAN

DOOSAN

Lifting Capacity

Lift more weight with each cycle and complete the job faster with Doosan excavators designed and tested to maximize lifting capability. With an optimal swing radius, lift height and tilt position you can lift and place loads and dig with greater productivity.

DOOSAN DELIVERS *Productivity*

Fast, powerful and efficient, Doosan excavators are designed to pack more work into the average workday.

Fast Cycle Times

Two variable displacement axial piston pumps deliver superior cycle times while hydraulic flow regeneration maximizes efficiency.



Interim Tier 4 (iT4) Compliant

Optimized to provide the ultimate in power delivery and fuel economy, Doosan excavators are designed with iT4 compliant engines to reduce air pollution.

Cooled Exhaust Gas Recirculation (CEGR)

CEGR recycles a portion of the engine exhaust to reduce oxygen and lower the temperature in the combustion chamber. This greatly reduces nitrogen oxide emissions (NOX).

Variable Geometry Turbocharger (VGT)

Changes the air flow to the engine as needed for more complete fuel combustion and increased boost at lower RPMs, delivering more power and efficiency.

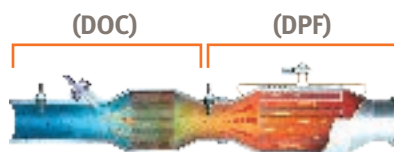

Diesel Oxidation Catalyst (DOC)

Using DOC technology, particulate matter (PM) emissions are transformed into harmless water and carbon dioxide.

Diesel Particulate Filter (DPF)

Exhaust enters the DPF where it's filtered further. The result is cleaner diesel exhaust and a healthier environment.

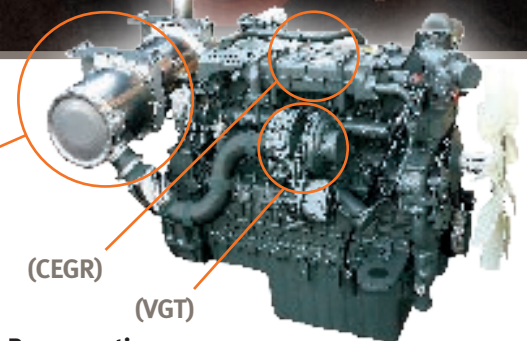

Regeneration

The DPF requires continuous regeneration to filter exhaust properly. Passive regeneration occurs with exhaust heat only. An active regeneration initiates automatically if the ECU detects certain levels of particulate matter in the DPF. It does not interfere with normal machine operation. If required, manual regeneration can be initiated by the operator.



Auto Idle

The standard auto idle feature automatically idles your engine when machine functions are not used for four seconds. This reduces noise, improves jobsite communications and saves fuel. When you move the controls, the excavator automatically returns to your previous engine throttle setting.

Auto Downshift

When turning, pushing and maneuvering, auto downshift reduces the hydraulic flow to the drive system – improving machine responsiveness and controllability. When the load decreases, the excavator automatically shifts back into high range.

Electronic Power Optimizing System (EPOS)

The EPOS works in conjunction with the engine’s ECU to monitor and optimize machine performance for increasing productivity while reducing fuel consumption.

D·ECOPOWER

Improve productivity and save fuel.

A pressure controlled pump, closed center main control valve and various sensors in the DX350LC-3, electronically detect and control the precise amount of hydraulic oil required to perform a task. The hydraulic system output requirements are optimized with engine horsepower. The resulting efficiency improves productivity and reduces fuel consumption. Improved feedback through the controls results in smoother machine control and enhanced operator comfort.

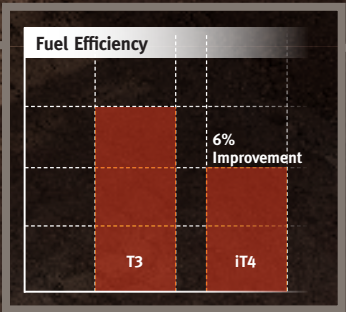

Fuel Efficiency

The Doosan excavator’s efficient horsepower curve delivers increased torque while using less fuel. Its high pressure common rail fuel injection system aides in reducing emissions and allows your Interim Tier 4-compliant engine to save fuel and improve performance.



X-Chassis Undercarriage

Get increased ground clearance and maneuverability in softer ground with the X-Chassis undercarriage design. The sloped surfaces also shed debris faster, reducing material buildup and cutting back your cleanup time.

DOOSAN DELIVERS *Durability/Reliability*

Like you, Doosan excavators are ready to keep at it until the job is finished. They're protected with solid construction and heavy-duty features that keep you running longer—so you can make more money working and spend less downtime in the shop.

Cast Ends and Pin Bosses

All the major pin points on the boom and arm are castings for extra strength in tough working conditions. Plus, additional reinforcement around the bosses and internal gussets give a long life for the workgroup.



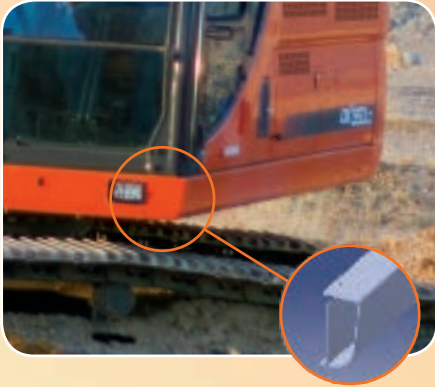

D-Channel Frame Design

This innovative upper structure frame design adds strength to withstand more side shock, protecting your machine's vital components.

Air-to-Air Fuel Cooler

The air-to-air fuel cooler reduces fuel temperature to increase your machine's overall efficiency and protect engine components.

Split Cooling

The split cooling system allows the oil cooler and radiator to operate independently to optimize the hydraulic system and engine temperatures, even in severe working conditions. The system increases cooling capacity while protecting and extending the life of engine components.

Reversible Fan

Standard on the DX420LC — DX530LC, the variable speed radiator cooling fan can be reversed to assist in keeping the cooling system clean in extremely dusty applications. The operator can reverse the fan by pressing a console switch to assist in keeping the machine running at optimal performance.



Heavy Duty Wear Plates

Ultra-hard and wear-resistant, these plates at the end of your arm and H-link extend the service intervals for your bucket pin-up point. By minimizing the tolerance between the bucket and arm, they maintain high breakout forces and ensure greater productivity.

Variable Speed Cooling Fan

The oil cooler on the DX300LC-3 — DX530LC-3 and also the radiator on the DX420LC-3 — DX530LC-3 utilize the variable speed cooling fan. The speed of the fan changes as required by the demands of your excavator. In tough, difficult applications, the fan runs faster for optimized cooling. When you're in lighter duty conditions, the fan runs slower to increase efficiency and reduce noise.

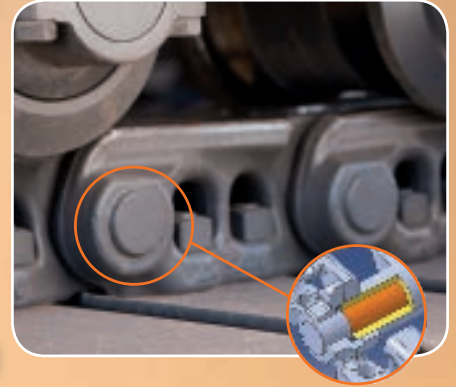

Permanently Sealed, Lubricated Track Pins

Pin links on Doosan excavator tracks are permanently sealed. They never need greasing. That means you reduce your operating costs and increase your uptime.



Recessed Drive Motors

Drive motors contained and recessed within the track width are protected from potential damage, resulting in more uptime.



DOOSAN DELIVERS *Comfort*

An operator can't push performance to the limit if the cabin isn't comfortable. Doosan knows how essential comfort is for its operators. From its great visibility to its deluxe, adjustable seat, Doosan cabins are easy to enter and exit, give you awesome standard features and bring superior comfort to the job.



Visibility

Sightlines to the work group are essential to operator performance. The large Doosan cabin provides an excellent viewing area on the front and side windows. When loading trucks or working overhead, the overhead window gives you great visibility above the machine. Narrow corner pillars, small

window joints and a wiper mounted on the pillar – instead of on the glass surface – give the operator a better view. Sun shades on the front and top windows shield operators from the sun and reduce eye strain. It's a complete visibility package that allows you to focus on your work instead of struggling to see it.

Other Cabin Features

- Improved floor space for your feet, increased cab space for your legs, arms, and head
- 180-degree swinging door
- Wide entry/exit area
- Grab handles
- Standard radio and antenna
- Standard CD player and MP3 player input
- 12 V power port
- Adjustable side window openings for fresh air

Quiet Operation

A complete, sound-isolating cabin seal reduces the noise inside the pressurized cab to an extremely low level. Compartmentalized components reduce noise output outside the cab. Even the cabin frame and seat are designed to absorb vibration and significantly increase operator comfort.

Adjustable comfort

The standard air suspension seat has multiple adjustment points, allowing you to select the most comfortable position.

- A Control Stand/Seat Base Fore/Aft
- B Control Stand/Seat move with suspension
- C Control Stand/Seat Height
- D Seat Fore/Aft
- E Seat Cushion Fore/Aft
- F Seat Cushion Angle
- G Back Recline
- H Lumbar Support
- I Headrest Fore/Aft & Up/Down
- J Control Stands Up/Down
- K Seat Heater

Automotive Style Heat and Air Conditioning

High capacity heating and cooling vents and an easy-to-control temperature keep you comfortable all year long. Automatic temperature control senses and adjusts to the temperature setting automatically. A memory function returns it to your preferred temperature if you shut the machine off and restart later.

Standard Rearview Camera

Provides the operator with an additional means to view the machine's surroundings allowing for increased productivity.



Easy-to-read LCD Display Panel

An easy-to-read LCD display panel is placed within easy view for monitoring critical machine data, viewing errors, warnings and the rearview camera display. A big, seven-inch display also switches to a night view.



DOOSAN DELIVERS *Easy Maintenance*

Even the best equipment needs regular maintenance. When it's time to take care of your excavator, Doosan makes it easy with onboard diagnostic systems, easy component access plus a standard fleet management system. If you want a long lasting machine and minimum effort to get it, Doosan delivers everything you need.



Ground level access to all filters



Easy access to regular inspection points



Doosan Telematics (GPS)

A simple user interface, accessible online via a web-enabled computer or cell phone, provides location information and a full range of machine operational information to you, your dealer and Doosan, allowing a complete machine maintenance management strategy to reduce operating costs.

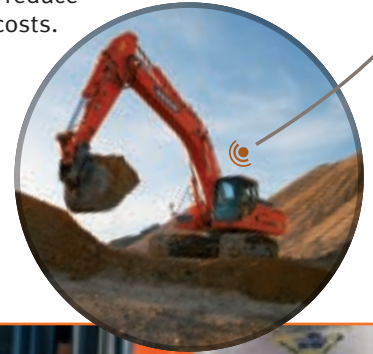

Easy Component Access

Access panels are easy to find and open from the top, bottom and sides of the excavator. A large engine bonnet provides plenty of room to reach the top side of the engine, while a hinged belly pan allows access from the bottom. Solid steel side panels provide access to regular daily maintenance items which make for quick, easy service and a lower cost of operation.



Oil & Filter Life

Easily review the hours since the last maintenance for filters and oils. Your machine will remind you when each oil and filter needs replacing 10 working hours before service is due, assisting you in regular maintenance scheduling.

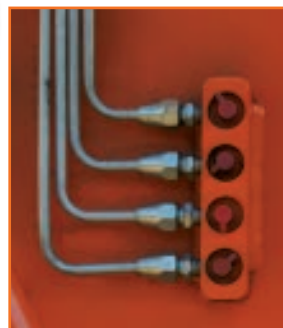

Centralized Arm and Boom Grease Points

Daily maintenance is critical—and it's simple with the centralized grease banks on the arm and base of the boom.

Doosan Monitoring System with Laptop Access

The Doosan Monitoring System is a diagnostic program that gives your dealer's technician a direct communications link with your excavator. During operation, it monitors all critical data and provides a complete history of operation and a real-time log of machine failures. Armed with information like this, your dealer service personnel can fix issues faster — and you can get back to work.

Auxiliary Mode Switch

If needed, an auxiliary mode switch allows you to finish a job or move your excavator to a convenient location for service.

Self-Diagnostics

The LCD monitor helps you monitor critical systems in real time. Plus, you can access historical machine alerts right from the screen in the cabin.

DOOSAN DELIVERS *Versatility*

Doosan excavators are optimized for attachment versatility. They can be matched to virtually any attachment designed for its operating weight and load ratings.

Doosan Attachments

Gear up for your job with the hard-working line of Doosan attachments for excavators and loaders. We build our own tough breakers, grapples, clamps, plate compactors and a wide array of bucket types and sizes. All of them are built to Doosan machine specifications for superior reliability and performance.



Selectable Work Modes

Four unique work modes enable you to tailor your excavator's performance to the work in front of you. Two modes recalibrate machine power for digging or lifting. Two change the auxiliary hydraulic flow for specific types of attachments. Just change a few settings with the LCD display panel to quickly optimize performance and protect your hydraulic components:

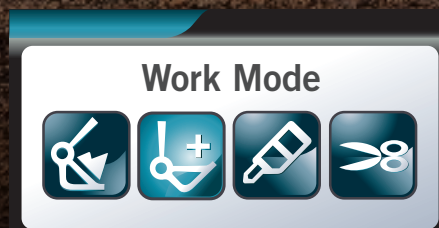

Digging

Your default setting delivers the performance you need for general excavation, loading and lifting. The four power modes give it a huge range of versatility for many different digging applications.



Lifting

The increased pump torque, low engine RPMs and automatic power boost provides extra muscle when lifting materials – like pipe or concrete barriers.



Hydraulic Attachment Management

Using the LCD screen, the operator can configure 10 different attachment presets: 5 each for 1-way and 2-way flow. Each preset selection can be matched to specific operational requirements of an attachment by limiting the maximum pressure and the minimum/maximum flow rate that is delivered to the attachment.

When changing hydraulic attachments, the operator can easily select the appropriate preset to optimize machine and attachment functionality. Password protection functionality within the system discourages improper attachment preset selection for operators or rental users with limited understanding of hydraulic systems.

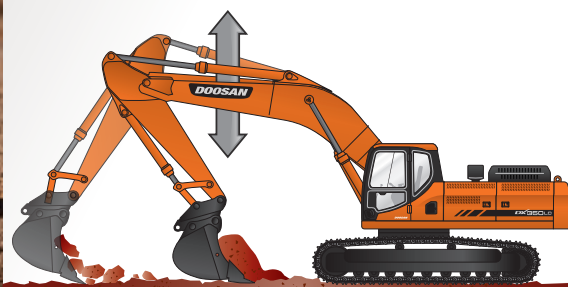

Breaker, or one-way auxiliary hydraulic flow, works great for attachments that only require hydraulic power from one direction, such as breakers or plate compactors. This mode also maintains consistent downward pressure for maximum attachment performance and component protection.



Shear, or two-way auxiliary hydraulic flow, is ideal for attachments that need bi-directional hydraulic flow, such as a hydraulic clamp, tilting bucket or shear.

Roller Switch

Easily control and vary the speed at which a two-way hydraulic attachment functions, such as opening and closing a hydraulic clamp, with the roller switch on the right joystick.



Intelligent Floating Boom

The boom float setting allows the boom to move freely with the contours of the ground. Ideal for finishing work, operators can focus on the arm and bucket. When engaged, the boom does not utilize hydraulic flow, increasing efficiency and productivity by saving fuel and improving cycle times.

General

STANDARD CONFIGURATION

	UNIT	DX300LC-3	DX350LC-3	DX420LC-3	DX490LC-3	DX530LC-3
ENGINE						
MODEL		Doosan DL08K	Doosan DL08K	Isuzu AL-6UZ1X	Isuzu AL-6WG1X	Isuzu AL-6WG1X
NUMBER OF CYLINDERS		6	6	6	6	6
RATED POWER GROSS (HP per SAE J1995)	hp (kW) @ rpm	213 (159) @ 1,800	281 (210) @ 1,800	362 (270) @ 2,000	389 (290) @ 1,800	389 (290) @ 1,800
RATED POWER NET (HP per SAE J1349)	hp (kW) @ rpm	201 (152) @ 1,800	271 (202) @ 1,800	345 (258) @ 2,000	370 (276) @ 1,800	370 (276) @ 1,800
MAXIMUM TORQUE (GROSS) (SAE J1995)	ft.-lb. (Nm) @ rpm	716 (971) @ 1,300	940 (1275) @ 1,300	1,056 (1432) @ 1,500	1,431 (1940) @ 1,350	1,431 (1940) @ 1,350
PISTON DISPLACEMENT	in ³ (cc)	466 (7640)	466 (7640)	573 (9389)	957 (15 681)	957 (15 681)
BORE AND STROKE	in. x in. (mm x mm)	4.3" x 5.5" (108 x 139)	4.3" x 5.5" (108 x 139)	4.7x5.7 (120x145)	5.8x6.1 (147x154)	5.8x6.1 (147x154)
STARTER	V, kW	24V, 6 kW	24V, 6 kW	24 V, 5.5 kW	24 V, 7.0 kW	24 V, 7.0 kW
BATTERIES	V, AH	2 x 12V, 150AH	2 x 12V, 150AH	2 x 12V, 150AH	2 x 12V, 150AH	2 x 12V, 150AH
AIR CLEANER		Double Elements	Double Elements	Double Elements	Double Elements	Double Elements
HYDRAULICS						
MAIN PUMPS	gpm (L/min)	2 x 65.5 (2 x 248)	2 x 95.1 (2 x 360)	2x88 (2x333)	2x95.1 (2x360)	2x95.1 (2x360)
PILOT PUMP Gear design	gpm (L/min)	7.5 (28.5)	6.4 (24.1)	6.37 (24.12)	6.37 (24.12)	6.37 (24.12)
RELIEF PRESSURE (Normal)	psi (kg/cm ²)	4,978 (350)	5,512 (387.5)	4,694 (330)	4,694 (330)	4,694 (330)
RELIEF PRESSURE (Boost)	psi (kg/cm ²)	5,263 (370)	N/A (N/A)	4,978 (350)	4,978 (350)	4,978 (350)
MAXIMUM SYSTEM PRESSURE						
BOOM/ARM/BUCKET (Normal Mode)	psi (kg/cm ²)	4,978 (350)	5,512 (387.5)	4694 (330)	4,694 (330)	4,694 (330)
BOOM/ARM/BUCKET (Power Mode)	psi (kg/cm ²)	5,263 (370)	N/A (N/A)	4978 (350)	4,978 (350)	4,978 (350)
TRAVEL (Normal Mode)	psi (kg/cm ²)	4,978 (350)	5,512 (387.5)	4694 (330)	4,694 (330)	4,694 (330)
TRAVEL (Power Mode)	psi (kg/cm ²)	5,263 (370)	N/A (N/A)	4978 (350)	4,978 (350)	4,978 (350)
SWING (Normal Mode)	psi (kg/cm ²)	4,978 (350)	5,512 (387.5)	4694 (330)	4,694 (330)	4,694 (330)
SWING (Power Mode)	psi (kg/cm ²)	5,263 (370)	N/A (N/A)	4978 (350)	4,978 (350)	4,978 (350)
UNDERCARRIAGE						
UPPER ROLLERS (Each Track)		2	2	2	3	3
LOWER ROLLERS (Each Track)		9	9	9	9	9
NUMBER OF SHOES (LINKS PER SIDE)		48	48	50	53	53
TOTAL LENGTH OF TRACK	ft. in. (mm)	16'2" (4940)	16'2" (4940)	17'1" (5200)	17'11" (5455)	17'11" (5455)
ENVIRONMENT						
SOUND LEVEL (2000/14/EC)	dB(A)	104	104	104	107	107
CABIN SOUND LEVEL (ISO 6396)	dB(A)	71	71	72	72	72
SWING MECHANISM						
SWING SPEED	rpm	0 - 9.9	0 - 9.3	0 - 8.82	0 - 8.54	0 - 8.54
SWING TORQUE	lbf.-ft. (kgf-m)	83,398 (11 530)	92,839 (12 835)	118,332 (16 360)	145,600 (20 130)	145,600 (20 130)
DRIVE SYSTEM						
TRAVEL SPEED [LOW - HIGH]	mph (km/h)	1.9 - 3.3 (3.0 - 5.3)	2.1 - 3.4 (3.4 - 5.4)	2.1/3.4(3.3/5.5)	1.9/3.4(3.1/5.4)	1.9/3.4(3.1/5.4)
DRAWBAR PULL	lbf. (kgf)	76,941 (34 900)	83,516 (37 882)	85,747 (38 894)	95,603 (43 365)	95,603 (43 365)
MAXIMUM GRADE	% / Degrees	70 / 35°	70 / 35°	70 / 35°	70 / 35°	70 / 35°
REFILL CAPACITIES						
FUEL TANK	gal. (L)	132.1 (500)	158.5 (600)	169 (640)	181 (685)	181 (685)
COOLING SYSTEM (RADIATOR CAPACITY)	gal. (L)	13.2 (50)	13.7 (52)	18.5 (70)	23.8 (90)	23.8 (90)
ENGINE OIL	gal. (L)	9.5 (36)	9.5 (36)	10.8 (41)	15.1 (57)	15.1 (57)
SWING DRIVE	gal. (L)	1.6 (6)	1.6 (6)	2.1 (7.9)	2x1.32(2x5)	2x1.32 (2x5)
FINAL DRIVE (EACH SIDE)	gal. (L)	1.8 (7)	1.8 (7)	2x1.7 (2x6.3)	2x2.64 (2x10)	2x2.64 (2x10)
HYDRAULIC SYSTEM	gal. (L)	82 (310)	119 (450)	132 (500)	132 (500)	132 (500)
HYDRAULIC TANK	gal (L)	44 (165)	63 (240)	103 (390)	103 (390)	103 (390)

NOTE — Where applicable, dimensions are in accordance with Society of Automotive Engineers (SAE) and ISO standards. Specifications and design are subject to change without notice. Pictures of Doosan excavators may show other than standard equipment. All dimensions are shown in inches. Respective metric dimensions are enclosed by parentheses. Doosan equipment is manufactured with a Quality Management System that is in compliance with ISO 9001:2008.

All Dimensions are given for Doosan excavators equipped with standard tracks.

Weight

	UNIT	DX300LC-3	DX350LC-3	DX420LC-3	DX490LC-3	DX530LC-3
CATEGORY						
BOOM	ft. in. (mm)	20'6" (6245)	21'4" (6500)	22' (6700)	23'4" (7100)	23'4" (7100)
ARM	ft. in. (mm)	10'2" (3100)	10'6" (3200)	10'8" (3250)	11' (3350)	9'6" (2900)
BUCKET	yd ³ (m ³)	1.66 (1.27)	1.96 (1.49)	2.5 (1.9)	2.8 (2.14)	3.7 (2.85)
DIMENSIONS (TRIPLE GROUSER)						
SHOE WIDTH - 2'0" (600mm) OPERATING WEIGHT GROUND PRESSURE	lb. (kg) psi (kgf/cm ²)	66,095 (29 980) 8.1 (0.57)	76,926 (34 893) 9.4 (0.66)	92,374 (41 900) 10.8 (0.76)	108,467 (49 200) 12.1 (0.85)	115,178 (52 244) 12.7 (0.89)
SHOE WIDTH - 2'4" (700mm) OPERATING WEIGHT GROUND PRESSURE	lb. (kg) psi (kgf/cm ²)	66,932 (30 360) 7.1 (0.5)	77,764 (35 273) 8.1 (0.57)			
SHOE WIDTH - 2'6" (750mm) OPERATING WEIGHT GROUND PRESSURE	lb. (kg) psi (kgf/cm ²)			93,970 (42 624) 8.8 (0.62)	110,672 (50 200) 9.8 (0.69)	117,383 (53 244) 10.4(0.73)
SHOE WIDTH - 2'7" (800mm) OPERATING WEIGHT GROUND PRESSURE	lb. (kg) psi (kgf/cm ²)	67,770 (30 740)* 6.3(0.44)*	78,601 (35 653)* 7.1 (0.5)*	94,503 (42 866)* 8.2 (0.58)*	111,285 (50 478) 9.2 (0.65)	117,996 (53 522) 9.8 (0.69)
SHOE WIDTH - 2'9" (850mm) OPERATING WEIGHT GROUND PRESSURE	lb. (kg) psi (kgf/cm ²)	68,167 (30 920) 5.7 (0.40)	78,998 (35 833) 6.8 (0.48)			
SHOE WIDTH - 2'11" (900mm) OPERATING WEIGHT GROUND PRESSURE	lb. (kg) psi (kgf/cm ²)		79,395 (36 013) 6.5 (0.46)	95,566 (43 348) 7.5 (0.53)	112,502 (51 030)* 8.2 (0.58)*	119,213 (54 074)* 8.8 (0.62)*
CATEGORY		DX300LC-3 SLR				DX530LC-3 SLR
BOOM	ft. in. (mm)	20' 6" (6245)				36'1" (11 000)
ARM	ft. in. (mm)	10' 2" (3100)				26'3" (8000)
BUCKET	yd ³ (m ³)	0.84 (0.64)				1.22(.93)
DIMENSIONS (TRIPLE GROUSER)						
SHOE WIDTH - 2'9" (850mm) OPERATING WEIGHT GROUND PRESSURE	lb. (kg) psi (kgf/cm ²)	68,167, (30 920)* 5.7 (0.40)*				
SHOE WIDTH - 2'11" (900mm) OPERATING WEIGHT GROUND PRESSURE	lb. (kg) psi (kgf/cm ²)					118,013 (53 530)* 8.7 (0.61)*

* = Standard Shoe Size

Hydraulic Cylinders

	UNIT	DX300LC-3	DX350LC-3	DX420LC-3	DX490LC-3	DX530LC-3
BOOM (2)						
BORE x ROD DIAMETER x STROKE (STD & SLR)	in. x in. x in. (mm x mm x mm)	5.5" x 3.7" x 57" (140 x 95 x 1450)	5.9" x 3.9" x 57" (150 x 100 x 1450)	6.7" x 4.5" x 58.5" (170 x 115 x 1485)	6.7" x 4.5" x 65" (170 x 115 x 1650)	6.7" x 4.5" x 65" (170 x 115 x 1650)
ARM (1)						
BORE x ROD DIAMETER x STROKE (STD & SLR)	in. x in. x in. (mm x mm x mm)	5.9" x 4.1" x 66" (150 x 105 x 1670)	6.7" x 4.7" x 71" (170 x 120 x 1805)	7.1" x 4.7" x 71.7" (180 x 120 x 1820)	7.15" x 5.1" x 78" (190 x 130 x 1980)	7.5" x 5.1" x 78" (190 x 130 x 1980)
BUCKET (1)						
BORE x ROD DIAMETER x STROKE (STD)	in. x in. x in. (mm x mm x mm)	5.3" x 3.5" x 45" (135 x 90 x 1150)	5.9" x 3.9" x 51" (150 x 100 x 1300)	6.3" x 4.3" x 52" (160 x 110 x 1320)	6.7" x 4.5" x 53" (170 x 115 x 1341)	6.7" x 4.5" x 53" (170 x 115 x 1341)
BORE x ROD DIAMETER x STROKE (SLR)	in. x in. x in. (mm x mm x mm)	3.7" x 2.6" x 35" (95 x 65 x 900)				4.7" x 3.1" x 42" (120 x 80 x 1060)

The piston rods and cylinder bodies are made of high-strength steel. A shock absorbing mechanism is fitted in all cylinders to ensure shock-free operation and extend piston life.

Specifications

Bucket

DX300LC-3

					20' 3" (4600 mm)			
					10' 2" (3100 mm)		12' 3" (3750 mm)	
					FIXED		FIXED	
					31.5" (800 mm)		33.5" (850 mm)	
					PIN ON	QUICK COUPLER	PIN ON	QUICK COUPLER
BUCKET TYPE	MODEL	CAPACITY ¹ yd ³ (m ³)	WIDTH in. (mm)	WEIGHT lb. (kg)				
HEAVY DUTY ^{2,3}	HF50-024	0.67 (0.51)	26 (660)	1,530 (694)	A	A	A	A
	HF50-030	0.89 (0.68)	32 (813)	1,709 (775)	A	A	A	A
	HF50-036	1.12 (0.86)	38 (965)	1,975 (896)	A	A	A	A
	HF50-042	1.36 (1.04)	44 (1118)	2,097 (951)	A	A	A	A
	HF50-048	1.61 (1.23)	50 (1270)	2,229 (1011)	A	A	A	B
	HF50-054	1.84 (1.41)	56 (1422)	2,423 (1099)	A	B	B	C
DITCHING ⁴	BS960	1.26 (0.96)	60 (1500)	1,798 (816)	A	A	A	A
	BS972	1.54 (1.18)	72 (1829)	1,951 (885)	A	A	A	B
	BS984	1.82 (1.39)	84 (2134)	2,369 (1075)	A	B	B	C

DX300LC-3 SLR

					32' 10" (10 000 mm)			
					23' (7000 mm)			
					FIXED			
					33.5" (850 mm)			
					PIN ON			
BUCKET TYPE	MODEL	CAPACITY ¹ yd ³ (m ³)	WIDTH in. (mm)	WEIGHT lb. (kg)				
HEAVY DUTY ^{2,3}	HF40-018	0.27 (0.21)	20 (508)	772 (350)	A			
	HF40-024	0.41 (0.31)	26 (660)	878 (398)	A			
	HF40-030	0.55 (0.42)	32 (813)	1,013 (459)	A			
	HF40-036	0.68 (0.52)	38 (965)	1,147 (520)	B			
	HF40-042	0.82 (0.63)	44 (1118)	1,253 (568)	C			
DITCHING ⁴	BS8B48	0.64 (0.49)	48 (1219)	602 (273)	A			
	BS8B60	0.80 (0.61)	60 (1524)	908 (412)	C			
	BS8B72	0.98 (0.75)	72 (1829)	1,047 (475)	C			

- 1 Capacity based on ISO 7451
- 2 Equipped with Side Cutters
- 3 Equipped with Bolt On Teeth
- 4 Equipped with Bolt On Cutting Edge

Maximum Suitable Material Density
 A 3,370 lb./yd³ (2000 kg/m³)
 B 2,700 lb./yd³ (1600 kg/m³)
 C 1,850 lb./yd³ (1100 kg/m³)
 X Not Approved

DX350LC-3

					21' 4" (6500 mm)			
					10' 6" (3200 mm)		13' (3950 mm)	
					FIXED		FIXED	
					31.5" (800 mm)		33.5" (850 mm)	
					PIN ON	QUICK COUPLER	PIN ON	QUICK COUPLER
BUCKET TYPE	MODEL	CAPACITY ¹ yd ³ (m ³)	WIDTH in. (mm)	WEIGHT lb. (kg)				
HEAVY DUTY ^{2,3}	HF58-030	1.06 (0.81)	32 (813)	2,280 (1034)	A	A	A	A
	HF58-036	1.32 (1.01)	38 (965)	2,530 (1148)	A	A	A	A
	HF58-048	1.88 (1.44)	50 (1270)	3,018 (1369)	A	B	B	C
	HF58-054	2.17 (1.66)	56 (1422)	3,224 (1462)	B	C	B	C
	HF58-060	2.46 (1.88)	62 (1575)	3,443 (1557)	B	C	C	X
DITCHING ⁴	BS972	1.54 (1.18)	72 (1829)	1,951 (885)	A	A	A	A
	BS984	1.82 (1.39)	84 (2134)	2,369 (1075)	A	A	A	B

DX420LC-3

					22' (6700 mm)			
					10' 8" (3250 mm)		13' (3950 mm)	
					Fixed		Fixed	
					31.5" (800 mm)		35.4" (900 mm)	
					PIN ON	QUICK COUPLER	PIN ON	QUICK COUPLER
BUCKET TYPE	MODEL	CAPACITY ¹ yd ³ (m ³)	WIDTH in. (mm)	WEIGHT lb. (kg)				
HEAVY DUTY ^{2,3}	HF60-036	1.50 (1.15)	38 (965)	2,841 (1289)	A	A	A	A
	HF60-048	2.14 (1.64)	50 (1270)	3,382 (1534)	A	B	A	B
	HF60-054	2.51 (1.92)	56 (1422)	3,646 (1654)	A	B	B	C
	HF60-060	2.80 (2.14)	62 (1575)	3,922 (1779)	B	C	C	C
	HF60-066	3.23 (2.47)	68 (1727)	4,387 (1990)	C	C	C	X

Bucket

DX490LC-3

BOOM	23' 4" (7100 mm)			
ARM	11' (3350 mm)		11' (3350 mm)	
TRACK TYPE	Variable		Fixed	
SHOE SIZE	35.4" (900 mm)		35.4" (900 mm)	
MOUNT	PIN ON	QUICK COUPLER	PIN ON	QUICK COUPLER

BUCKET TYPE	MODEL	CAPACITY ¹ yd ³ (m ³)	WIDTH in. (mm)	WEIGHT lb. (kg)				
HEAVY DUTY ^{2,3}	HF65-042	2.0 (1.53)	44 (1118)	3,629 (1646)	A	A	A	B
	HF65-048	2.35 (1.80)	50 (1270)	4,015 (1821)	A	B	A	C
	HF65-054	2.71 (2.07)	56 (1422)	4,202 (1906)	A	C	B	C
	HF65-060	3.07 (2.35)	62 (1575)	4,515 (2048)	B	C	C	X
	HF65-066	3.56 (2.72)	68 (1727)	4,963 (2251)	C	X	C	X

DX530LC-3

BOOM	23' 4" (7100 mm)			
ARM	9' 6" (2900 mm)		11' (3350 mm)	
TRACK TYPE	VARIABLE		VARIABLE	
SHOE SIZE	35.4" (900 mm)		35.4" (900 mm)	
MOUNT	PIN ON	QUICK COUPLER	PIN ON	QUICK COUPLER

BUCKET TYPE	MODEL	CAPACITY ¹ yd ³ (m ³)	WIDTH in. (mm)	WEIGHT lb. (kg)				
HEAVY DUTY ^{2,3}	HF65-042	2.0 (1.53)	44 (1118)	3,629 (1646)	A	A	A	A
	HF65-048	2.35 (1.80)	50 (1270)	4,015 (1821)	A	A	A	A
	HF65-054	2.71 (2.07)	56 (1422)	4,202 (1906)	A	A	A	B
	HF65-060	3.07 (2.35)	62 (1575)	4,515 (2048)	A	B	A	B
	HF65-066	3.56 (2.72)	68 (1727)	4,963 (2251)	A	C	B	C
	HF65-072	3.81 (2.91)	74 (1880)	5,130 (2327)	B	C	B	C

DX530LC-3 SLR

BOOM	36' 1" (11 000 mm)
ARM	26' 3" (8000 mm)
TRACK TYPE	VARIABLE
SHOE SIZE	35.4" (900 mm)
MOUNT	PIN ON

BUCKET TYPE	MODEL	CAPACITY ¹ yd ³ (m ³)	WIDTH in. (mm)	WEIGHT lb. (kg)	
HEAVY DUTY ^{2,3}	HF50-024	0.67 (0.51)	26 (660)	1,530 (694)	A
	HF50-030	0.89 (0.68)	32 (813)	1,709 (775)	A
	HF50-036	1.12 (0.86)	38 (965)	1,975 (896)	A
	HF50-042	1.36 (1.04)	44 (1118)	2,097 (951)	B
	HF50-048	1.61 (1.23)	50 (1270)	2,229 (1011)	C
	HF50-054	1.84 (1.41)	56 (1422)	2,423 (1099)	C
DITCHING ⁴	BS960	1.26 (0.96)	60 (1500)	1,798 (816)	A
	BS972	1.54 (1.18)	72 (1829)	1,951 (885)	B
	BS984	1.82 (1.39)	84 (2134)	2,369 (1075)	C

- 1 Capacity based on ISO 7451
- 2 Equipped with Side Cutters
- 3 Equipped with Bolt On Teeth
- 4 Equipped with Bolt On Cutting Edge

Maximum Suitable Material Density

- A 3,370 lb./yd³ (2000 kg/m³)
- B 2,700 lb./yd³ (1600 kg/m³)
- C 1,850 lb./yd³ (1100 kg/m³)
- X Not Approved

Specifications

Dimensions

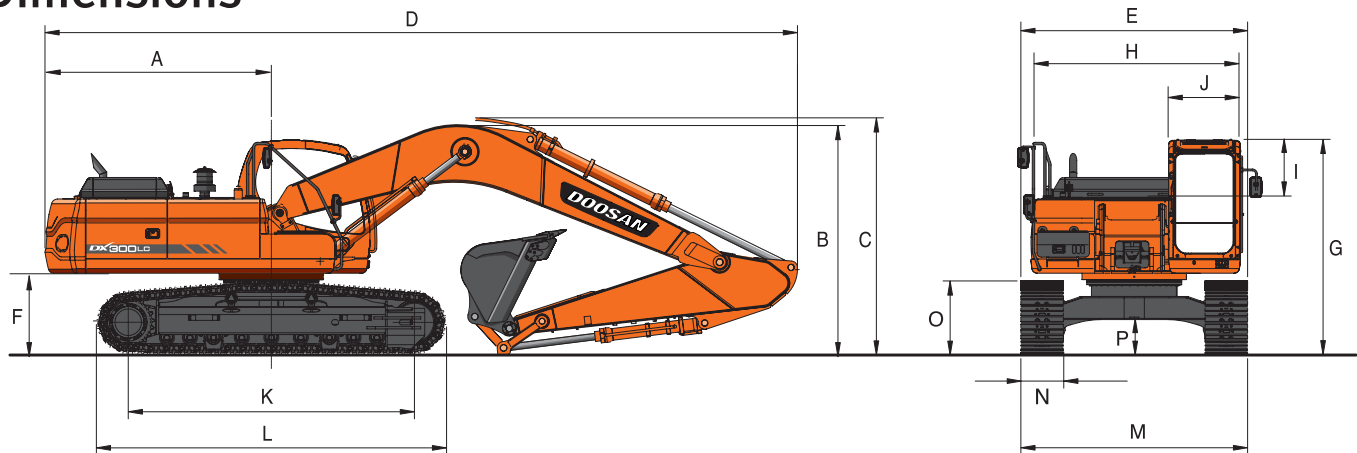

DX300LC-3

BOOM TYPE		ft-in (mm)	20'6" (6,245 mm) STD		32'10" (10,000) SLR
ARM TYPE		ft-in (mm)	10'2" (3100) STD	12'4" (3750)	23'0" (7000)
BUCKET TYPE (SAE)		yd ³ (m ³)	1.66 yd ³ (1.27)	1.35 yd ³ (1.03)	0.84 yd ³ (0.64)
TRACK TYPE			STANDARD	STANDARD	STANDARD
TAIL SWING RADIUS	A	ft-in. (mm)	10' 6" (3200)	10' 6" (3200)	10' 6" (3200)
SHIPPING HEIGHT (BOOM)	B	ft-in. (mm)	10' 9" (3265)	11' 4" (3455)	11' 0" (3365)
SHIPPING HEIGHT (HOSE)	C	ft-in. (mm)	11' 1" (3370)	11' 9" (3575)	11' 5" (3475)
SHIPPING LENGTH	D	ft-in. (mm)	34' 7" (10 540)	34' 11" (10 650)	46' 11" (14 290)
SHIPPING WIDTH	E	ft-in. (mm)	11' 2" (3400)	11' 4" (3450)	11' 4" (3450)
COUNTERWEIGHT CLEARANCE	F	ft-in. (mm)	3' 9" (1155)	3' 9" (1155)	3' 9" (1155)
CABIN HEIGHT	G	ft-in. (mm)	10' 1" (3070)	10' 1" (3070)	10' 1" (3070)
UPPER STRUCTURE WIDTH	H	ft-in. (mm)	9' 9" (2960)	9' 9" (2960)	9' 9" (2960)
CABIN HEIGHT ABOVE HOUSE	I	ft-in. (mm)	2' 9" (845)	2' 9" (845)	2' 9" (845)
CABIN WIDTH	J	ft-in. (mm)	3' 4" (1010)	3' 4" (1010)	3' 4" (1010)
TUMBLER DISTANCE	K	ft-in. (mm)	13' 3" (4040)	13' 3" (4040)	13' 3" (4040)
OVERALL TRACK LENGTH	L	ft-in. (mm)	16' 2" (4940)	16' 2" (4940)	16' 2" (4940)
UNDERCARRIAGE WIDTH	M	ft-in. (mm)	11' 2" (3400)	11' 4" (3450)	11' 4" (3450)
TRACK SHOE WIDTH	N	ft-in. (mm)	2' 7" (800)	2' 9" (850)	2' 9" (850)
TRACK HEIGHT	O	ft-in. (mm)	3' 6" (1058)	3' 6" (1058)	3' 6" (1058)
CAR BODY CLEARANCE	P	ft-in. (mm)	1' 8" (505)	1' 8" (505)	1' 8" (505)

DX350LC-3

BOOM TYPE		ft-in (mm)	21'4" (6,500 mm) STD	
ARM TYPE		ft-in (mm)	10'6" (3200) STD	13'0" (3950)
BUCKET TYPE (SAE)		yd ³ (m ³)	1.95 yd ³ (1.49)	1.63 yd ³ (1.25)
TRACK TYPE			STANDARD	STANDARD
TAIL SWING RADIUS	A	ft-in. (mm)	11' 6" (3500)	11' 6" (3500)
SHIPPING HEIGHT (BOOM)	B	ft-in. (mm)	10' 7" (3225)	11' 3" (3420)
SHIPPING HEIGHT (HOSE)	C	ft-in. (mm)	11' 1" (3390)	11' 8" (3550)
SHIPPING LENGTH	D	ft-in. (mm)	37' 0" (11 280)	37' 1" (11 300)
SHIPPING WIDTH	E	ft-in. (mm)	11' 5" (3480)	11' 5" (3480)
COUNTERWEIGHT CLEARANCE	F	ft-in. (mm)	3' 11" (1195)	3' 11" (1195)
CABIN HEIGHT	G	ft-in. (mm)	10' 3" (3125)	10' 3" (3125)
UPPER STRUCTURE WIDTH	H	ft-in. (mm)	9' 10" (2990)	9' 10" (2990)
CABIN HEIGHT ABOVE HOUSE	I	ft-in. (mm)	2' 9" (845)	2' 9" (845)
CABIN WIDTH	J	ft-in. (mm)	3' 4" (1010)	3' 4" (1010)
TUMBLER DISTANCE	K	ft-in. (mm)	13' 3" (4040)	13' 3" (4040)
OVERALL TRACK LENGTH	L	ft-in. (mm)	16' 2" (4940)	16' 2" (4940)
UNDERCARRIAGE WIDTH	M	ft-in. (mm)	11' 5" (3480)	11' 5" (3480)
TRACK SHOE WIDTH	N	ft-in. (mm)	2' 7" (800)	2' 7" (800)
TRACK HEIGHT	O	ft-in. (mm)	3' 5" (1048)	3' 5" (1048)
CAR BODY CLEARANCE	P	ft-in. (mm)	1' 8" (510)	1' 8" (510)

DX420LC-3

BOOM TYPE		ft-in (mm)	22' (6700) STD	
ARM TYPE		ft-in (mm)	10'8" (3250) STD	13' (3950)
BUCKET TYPE (SAE)		yd ³ (m ³)	2.49 yd ³ (1.9)	1.88 (1.44)
TRACK TYPE			STANDARD	STANDARD
TAIL SWING RADIUS	A	ft.-in. (mm)	12'4" (3760)	12'4" (3760)
SHIPPING HEIGHT (BOOM)	B	ft.-in. (mm)	11' (3350)	11'1" (3390)
SHIPPING HEIGHT (HOSE)	C	ft.-in. (mm)	11'4" (3455)	11'6" (3495)
SHIPPING LENGTH	D	ft.-in. (mm)	38'7" (11 750)	38'7" (11 750)
SHIPPING WIDTH	E	ft.-in. (mm)	11' 8" (3550)	12' (3650)
COUNTERWEIGHT CLEARANCE	F	ft.-in. (mm)	4'2" (1265)	4'2" (1265)
CABIN HEIGHT	G	ft.-in. (mm)	10'4" (3154)	10'4" (3154)
UPPER STRUCTURE WIDTH	H	ft.-in. (mm)	9'10" (2990)	9'10" (2990)
CABIN HEIGHT ABOVE HOUSE	I	ft.-in. (mm)	2'9" (845)	2'9" (845)
CABIN WIDTH	J	ft.-in. (mm)	3'4" (1010)	3'4" (1010)
TUMBLER DISTANCE	K	ft.-in. (mm)	13'11" (4250)	13'11" (4250)
OVERALL TRACK LENGTH	L	ft.-in. (mm)	17'1" (5200)	17'1" (5200)
UNDERCARRIAGE WIDTH	M	ft.-in. (mm)	11' 8" (3550)	12' (3650)
TRACK SHOE WIDTH	N	ft.-in. (mm)	31.5" (800)	35.4" (900)
TRACK HEIGHT	O	ft.-in. (mm)	3'5" (1050)	3'5" (1050)
CAR BODY CLEARANCE	P	ft.-in. (mm)	1'9" (540)	1'9" (540)

DX490LC-3

BOOM TYPE		ft-in (mm)	23'4" (7100) STD	
ARM TYPE		ft-in (mm)	11' (3350) STD	11' (3350)
BUCKET TYPE (SAE)		yd ³ (m ³)	2.8 yd ³ (2.14)	2.8 yd ³ (2.14)
TRACK TYPE			STD VARIABLE TRACK	FIXED TRACK
TAIL SWING RADIUS	A	ft.-in. (mm)	12'6" (3800)	12'6" (3800)
SHIPPING HEIGHT (BOOM)	B	ft.-in. (mm)	11'9" (3580)	11'3" (3430)
SHIPPING HEIGHT (HOSE)	C	ft.-in. (mm)	12'2" (3705)	11'8" (3555)
SHIPPING LENGTH	D	ft.-in. (mm)	40'1" (12 230)	40'3" (12 280)
SHIPPING WIDTH	E	ft.-in. (mm)	10'10" (3290)	11' (3350)
COUNTERWEIGHT CLEARANCE	F	ft.-in. (mm)	4'9" (1460)	4'4" (1310)
CABIN HEIGHT	G	ft.-in. (mm)	11' (3350)	10' 6" (3200)
UPPER STRUCTURE WIDTH	H	ft.-in. (mm)	9'10"/10'10" (2990/3296)*	9'10"/10'10" (2990/3296)*
CABIN HEIGHT ABOVE HOUSE	I	ft.-in. (mm)	2'9" (845)	2'9" (845)
CABIN WIDTH	J	ft.-in. (mm)	3'4" (1010)	3'4" (1010)
TUMBLER DISTANCE	K	ft.-in. (mm)	14'8" (4470)	14'8" (4480)
OVERALL TRACK LENGTH	L	ft.-in. (mm)	17'11" (5455)	17'11" (5465)
UNDERCARRIAGE WIDTH	M	ft.-in. (mm)	10' 10"/12' 5" (3290/3790)**	11' (3350)
TRACK SHOE WIDTH	N	ft.-in. (mm)	35.4" (900)	35.4" (900)
TRACK HEIGHT	O	ft.-in. (mm)	4' (1210)	4' (1140)
CAR BODY CLEARANCE	P	ft.-in. (mm)	2'6" (770)	1'10" (570)

DX530LC-3

BOOM TYPE		ft-in (mm)	23'4" (7100)		36'1" (11 000) SLR
ARM TYPE		ft-in (mm)	9' 6" (2900) STD	11' (3350)	26'3" (8000)
BUCKET TYPE (SAE)		yd ³ (m ³)	3.1 yd ³ (2.39)	2.8 yd ³ (2.14)	1.22 yd ³ (.93)
TRACK TYPE			Wide Variable Track	Wide Variable Track	Wide Variable Track
TAIL SWING RADIUS	A	ft.-in. (mm)	12'6" (3800)	12'6" (3800)	12'6" (3800)
SHIPPING HEIGHT (BOOM)	B	ft.-in. (mm)	12'6" (3800)	11'9" (3580)	12'11" (3935)
SHIPPING HEIGHT (HOSE)	C	ft.-in. (mm)	12'9" (3895)	12'2" (3705)	13'4" (4070)
SHIPPING LENGTH	D	ft.-in. (mm)	40'5" (12 330)	40'1" (12 230)	53'2" (16 195)
SHIPPING WIDTH	E	ft.-in. (mm)	11'11" (3640)	11'11" (3640)	11'11" (3640)
COUNTERWEIGHT CLEARANCE	F	ft.-in. (mm)	4'9" (1460)	4'9" (1460)	4'9" (1460)
CABIN HEIGHT	G	ft.-in. (mm)	11' (3350)	11' (3350)	11' (3350)
UPPER STRUCTURE WIDTH	H	ft.-in. (mm)	9'10"/10'10" (2990/3296)*	9'10"/10'10" (2990/3296)*	9'10"/10'10" (2990/3296)*
CABIN HEIGHT ABOVE HOUSE	I	ft.-in. (mm)	2'9" (845)	2'9" (845)	2'9" (845)
CABIN WIDTH	J	ft.-in. (mm)	3'4" (1010)	3'4" (1010)	3'4" (1010)
TUMBLER DISTANCE	K	ft.-in. (mm)	14'8" (4470)	14'8" (4470)	14'8" (4470)
OVERALL TRACK LENGTH	L	ft.-in. (mm)	17'11" (5455)	17'11" (5455)	17'11" (5455)
UNDERCARRIAGE WIDTH	M	ft.-in. (mm)	11'11"/13'9" (3640/4200)**	11'11"/13'9" (3640/4200)**	11'11"/13'9" (3640/4200)**
TRACK SHOE WIDTH	N	ft.-in. (mm)	35.4" (900)	35.4" (900)	35.4" (900)
TRACK HEIGHT	O	ft.-in. (mm)	4' (1210)	4' (1210)	4' (1210)
CAR BODY CLEARANCE	P	ft.-in. (mm)	2'6" (770)	2'6" (770)	2'6" (770)

* Without catwalk/with catwalks

** Retracted/extended

Specifications

Working Range

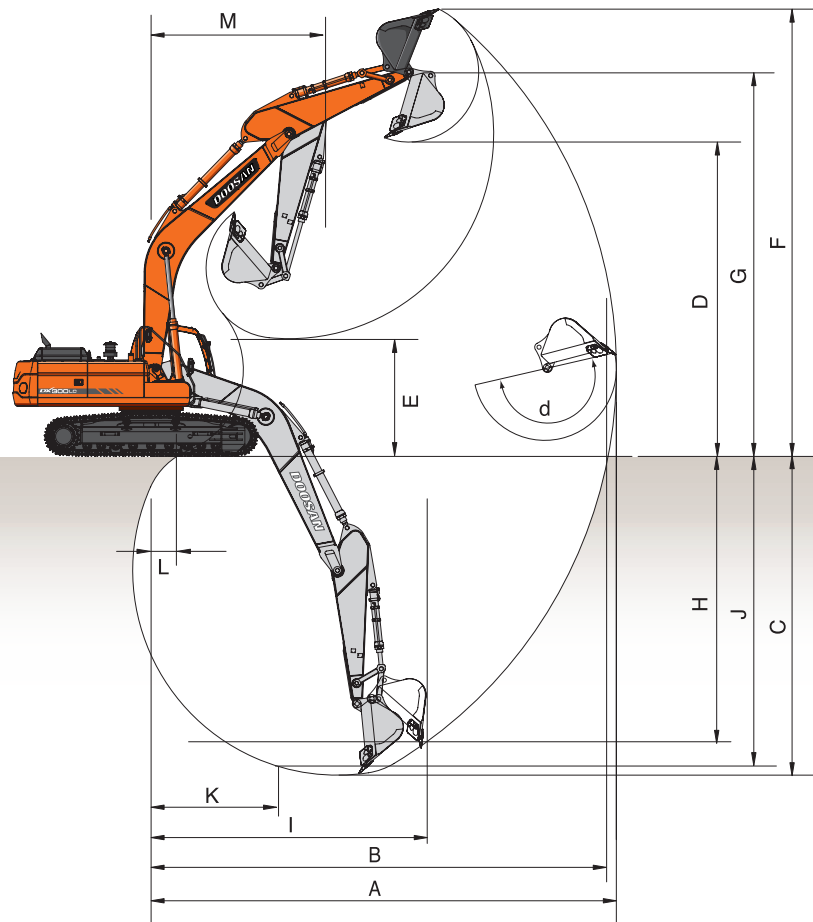

DX300LC-3

BOOM TYPE		ft-in (mm)	20'6" (6245) STD		32'10" (10 000) SLR
ARM TYPE		ft-in (mm)	10'2" (3100) STD	12'4" (3750)	23' (7000)
BUCKET TYPE (SAE) PCSA		yd ³ (m ³)	1.66 (1.27)	1.35 (1.03)	0.84 (0.64)
TRACK TYPE			STANDARD	STANDARD	STANDARD
MAX. DIGGING REACH	A	ft.-in. (mm)	35'2" (10 725)	36' 11" (11 240)	57' 5" (17 510)
MAX. DIGGING REACH (GROUND)	B	ft-in (mm)	34' 7" (10 530)	36' 4" (11 065)	57' 1" (17 390)
MAX. DIGGING DEPTH	C	ft.-in. (mm)	24' 0" (7305)	26' 1" (7950)	45' 3" (13 780)
MAX. LOADING HEIGHT	D	ft.-in. (mm)	23' 11" (7280)	24' 3" (7395)	39' 3" (11 975)
MIN. LOADING HEIGHT	E	ft.-in. (mm)	9' 0" (2750)	6' 11" (2110)	8' 11" (2730)
MAX. DIGGING HEIGHT	F	ft.-in. (mm)	33' 10" (10 325)	34' 2" (10 405)	46' 7" (14 195)
MAX. BUCKET PIN HEIGHT	G	ft.-in. (mm)	29' 2" (8880)	29' 6" (8990)	43' 7" (13 290)
MAX. VERTICAL WALL DEPTH	H	ft.-in. (mm)	20' 1" (6125)	21' 8" (6600)	38' 0" (11 590)
MAX. RADIUS VERTICAL	I	ft.-in. (mm)	22' 5" (6840)	23' 2" (7070)	35' 9" (10 900)
MAX. DEPTH TO 8' LINE	J	ft.-in. (mm)	23' 4" (7110)	25' 5" (7755)	43' 11" (13 395)
MIN. RADIUS 8' LINE	K	ft.-in. (mm)	9' 10" (3000)	9' 7" (2920)	13' 7" (4140)
MIN. DIGGING REACH	L	ft.-in. (mm)	2' 0" (620)	-0' 11" (-280)	3' 10" (1160)
MIN. SWING RADIUS	M	ft.-in. (mm)	13' 3" (4040)	13' 3" (4050)	20' 1" (6120)
BUCKET ANGLE (DEG)	d	Degrees	175°	174°	169°

DX350LC-3

		21'4" (6500) STD	
		10'6" (3200) STD	13'0" (3950)
		1.95 (1.49)	1.63 (1.25)
		STANDARD	STANDARD
MAX. DIGGING REACH	A	ft.-in. (mm)	36' 8" (11 170)
MAX. DIGGING REACH (GROUND)	B	ft-in (mm)	36' 0" (10 970)
MAX. DIGGING DEPTH	C	ft.-in. (mm)	24' 9" (7535)
MAX. LOADING HEIGHT	D	ft.-in. (mm)	23' 6" (7175)
MIN. LOADING HEIGHT	E	ft.-in. (mm)	8' 11" (2710)
MAX. DIGGING HEIGHT	F	ft.-in. (mm)	33' 10" (10 320)
MAX. BUCKET PIN HEIGHT	G	ft.-in. (mm)	29' 2" (8880)
MAX. VERTICAL WALL DEPTH	H	ft.-in. (mm)	19' 4" (5890)
MAX. RADIUS VERTICAL	I	ft.-in. (mm)	25' 4" (7720)
MAX. DEPTH TO 8' LINE	J	ft.-in. (mm)	24' 1" (7345)
MIN. RADIUS 8' LINE	K	ft.-in. (mm)	10' 11" (3320)
MIN. DIGGING REACH	L	ft.-in. (mm)	2' 4" (710)
MIN. SWING RADIUS	M	ft.-in. (mm)	14' 7" (4455)
BUCKET ANGLE (DEG)	d	Degrees	178°

DX420LC-3

BOOM TYPE		ft-in (mm)	22' (6700)	
ARM TYPE		ft-in (mm)	10'8" (3250) STD	13' (3950)
BUCKET TYPE (SAE) PCSA		yd ³ (m ³)	2.49 (1.9)	1.88 (1.44)
TRACK TYPE			STANDARD	STANDARD
MAX. DIGGING REACH	A	ft.-in. (mm)	37'9" (11 495)	40' (12 180)
MAX. DIGGING REACH (GROUND)	B	ft.-in. (mm)	37' (11 290)	39'4" (11 980)
MAX. DIGGING DEPTH	C	ft.-in. (mm)	25'5" (7740)	27'8" (8435)
MAX. LOADING HEIGHT	D	ft.-in. (mm)	25'4" (7710)	26'7" (8100)
MIN. LOADING HEIGHT	E	ft.-in. (mm)	9'10" (2995)	7'7" (2300)
MAX. DIGGING HEIGHT	F	ft.-in. (mm)	35'6" (10 820)	36'11" (11 240)
MAX. BUCKET PIN HEIGHT	G	ft.-in. (mm)	31' (9440)	32'3" (9830)
MAX. VERTICAL WALL DEPTH	H	ft.-in. (mm)	14'2" (4320)	16'9" (5110)
MAX. RADIUS VERTICAL	I	ft.-in. (mm)	31' (9440)	31'10" (9700)
MAX. DEPTH TO 8' LINE	J	ft.-in. (mm)	24'9" (7555)	27'2" (8290)
MIN. RADIUS 8' LINE	K	ft.-in. (mm)	11'3" (3420)	11'5" (3475)
MIN. DIGGING REACH	L	ft.-in. (mm)	2'7" (785)	(-225)
MIN. SWING RADIUS	M	ft.-in. (mm)	14'8" (4475)	14'11" (4555)
BUCKET ANGLE (DEG)	d	Degrees	183°	183.9°

DX490LC-3

BOOM TYPE		ft-in (mm)	23'4" (7100)	
ARM TYPE		ft-in (mm)	11' (3350) STD	11' (3350)
BUCKET TYPE (SAE) PCSA		yd ³ (m ³)	2.8 (2.14)	2.8 (2.14)
TRACK TYPE			STD VARIABLE TRACK	FIXED TRACK
MAX. DIGGING REACH	A	ft.-in. (mm)	39'9" (12 125)	39'9" (12 125)
MAX. DIGGING REACH (GROUND)	B	ft.-in. (mm)	38'11" (11 865)	39' (11 895)
MAX. DIGGING DEPTH	C	ft.-in. (mm)	25'7" (7790)	26'1" (7940)
MAX. LOADING HEIGHT	D	ft.-in. (mm)	25'10" (7865)	25'4" (7715)
MIN. LOADING HEIGHT	E	ft.-in. (mm)	10'3" (3130)	9'9" (2980)
MAX. DIGGING HEIGHT	F	ft.-in. (mm)	36'3" (11 050)	35'9" (1 0900)
MAX. BUCKET PIN HEIGHT	G	ft.-in. (mm)	31' 9" (9690)	31'4" (9540)
MAX. VERTICAL WALL DEPTH	H	ft.-in. (mm)	14'4" (4370)	14'10" (4520)
MAX. RADIUS VERTICAL	I	ft.-in. (mm)	32'9" (9970)	32'9" (9970)
MAX. DEPTH TO 8' LINE	J	ft.-in. (mm)	25'1" (7635)	25'6" (7785)
MIN. RADIUS 8' LINE	K	ft.-in. (mm)	12'9" (3895)	12'9" (3895)
MIN. DIGGING REACH	L	ft.-in. (mm)	2'9" (840)	3'6" (1055)
MIN. SWING RADIUS	M	ft.-in. (mm)	17'1" (5210)	17'1" (5210)
BUCKET ANGLE (DEG)	d	Degrees	189.1°	189.1°

DX530LC-3

BOOM TYPE		ft-in (mm)	23'4" (7100) STD		36'1" (11 000) SLR
ARM TYPE		ft-in (mm)	9'6" (2900) STD	11' (3350)	26'3" (8000)
BUCKET TYPE (SAE) PCSA		yd ³ (m ³)	3.1 (2.39)	2.8 (2.14)	1.22 (0.92)
TRACK TYPE			WIDE VARIABLE TRACK	WIDE VARIABLE TRACK	WIDE VARIABLE TRACK
MAX. DIGGING REACH	A	ft.-in. (mm)	38'5" (11 720)	39'9" (12 125)	64'4" (19 615)
MAX. DIGGING REACH (GROUND)	B	ft.-in. (mm)	37'7" (11 455)	38'11" (11 865)	63'10" (19 455)
MAX. DIGGING DEPTH	C	ft.-in. (mm)	24'1" (7340)	25'7" (7790)	49'7" (15 125)
MAX. LOADING HEIGHT	D	ft.-in. (mm)	25'4" (7725)	25'10" (7865)	39' (11 890)
MIN. LOADING HEIGHT	E	ft.-in. (mm)	11'9" (3580)	10'3" (3130)	4'10" (1465)
MAX. DIGGING HEIGHT	F	ft.-in. (mm)	35'10" (10 920)	36'3" (11 050)	47'4" (14 435)
MAX. BUCKET PIN HEIGHT	G	ft.-in. (mm)	31'4" (9550)	31'9" (9690)	43'10" (13 355)
MAX. VERTICAL WALL DEPTH	H	ft.-in. (mm)	13'3" (4045)	14'4" (4370)	42' (12 805)
MAX. RADIUS VERTICAL	I	ft.-in. (mm)	31'10" (9710)	32'9" (9970)	39'11" (12 165)
MAX. DEPTH TO 8' LINE	J	ft.-in. (mm)	23'6" (7165)	25'1" (7635)	49'3" (15 010)
MIN. RADIUS 8' LINE	K	ft.-in. (mm)	12'9" (3885)	12'9" (3895)	20'3" (6165)
MIN. DIGGING REACH	L	ft.-in. (mm)	6'7" (2010)	2'9" (840)	2" (40)
MIN. SWING RADIUS	M	ft.-in. (mm)	17'2" (5235)	17'1" (5210)	25'8" (7825)
BUCKET ANGLE (DEG)	d	Degrees	181.2°	189.1°	177.6°

Specifications

Digging Force (ISO)

DX300LC-3

BUCKET (PCSA)	BUCKET SIZE (SAE)	1.66 yd ³ (1.27 m ³) STD	1.98 yd ³ (1.51 m ³)	1.35 yd ³ (1.03 m ³)	0.84 yd ³ (0.64 m ³) SLR
DIGGING FORCE	lbf.	44,092	44,092	44,092	23,149
	kgf	20 000	20 000	20 000	10 500
	kN	196	196	196	103
ARM	ARM SIZE	10'2" STD. (3,100 mm)	12'4" (3,750 mm)	23' (7,000 mm)	
DIGGING FORCE	lbf.	30,644	27,337	16,535	
	kgf	13 900	12 400	7500	
	kN	136	122	74	

DX350LC-3

BUCKET (PCSA)	BUCKET SIZE (SAE)	1.95 yd ³ (1.49 m ³) STD	1.63 yd ³ (1.25 m ³)
DIGGING FORCE	lbf.	57,100	57,100
	kgf	25 900	25 900
	kN	254	254
ARM	ARM SIZE	10'6" (3,200 mm) STD.	13'0" (3,950 mm)
DIGGING FORCE	lbf.	41,667	35,274
	kgf	18 900	16 000
	kN	185	157

DX420LC-3

BUCKET (PCSA)	BUCKET SIZE (SAE)	1.56 yd ³ (1.19 m ³) STD	1.88 yd ³ (1.44 m ³)	2.20 yd ³ (1.68 m ³)
DIGGING FORCE	lbf.	59,745	59,745	59,745
	kgf	27 100	27 100	27 100
	kN	266	266	266
ARM	ARM SIZE	10'8" STD. (3250 mm)	13' (3950 mm)	
DIGGING FORCE	lbf.	193	166	
	kgf	43 431	37 258	
	kN	19 700	16 900	

DX490LC-3

BUCKET (PCSA)	BUCKET SIZE (SAE)	2.80 yd ³ (2.14 m ³) STD	1.54 yd ³ (1.18 m ³)	3.13 yd ³ (2.39 m ³)
DIGGING FORCE	lbf.	67,902	67,902	67,902
	kgf	30 800	30 800	30 800
	kN	302	302	302
ARM	ARM SIZE	11' STD. (3350 mm)		
DIGGING FORCE	lbf.	223		
	kgf	50 045		
	kN	22 700		

DX530LC-3

BUCKET (PCSA)	BUCKET SIZE (SAE)	3.73 yd ³ (2.85 m ³) STD	2.80 yd ³ (2.14 m ³)	1.22 yd ³ (0.93 m ³) SLR
DIGGING FORCE	lbf.	67,902	67,902	33,510
	kgf	30 800	30 800	15 200
	kN	302	302	149
ARM	ARM SIZE	9'6" STD. (2900 mm)	11' (3350 mm)	26'3" (8000 mm)
DIGGING FORCE	lbf.	253	223	117
	kgf	56 879	50 045	26 235
	kN	25 800	22 700	11 900

- Standard Equipment
- Optional Equipment
- N/A

Standard/Optional Equipment

	DX300LC-3	DX350LC-3	DX420LC-3	DX490LC-3	DX530LC-3
ENGINE					
Emissions (EPA)	iT4	iT4	iT4	iT4	iT4
Cooled Exhaust Gas Recirculation (CEGR)	•	•	•	•	•
Diesel Particulate Filter (DPF)	•	•	•	•	•
Variable Geometry (VGT)	•	•	•	•	•
High Pressure Common Rail (HPCR)	•	•	•	•	•
Fuel Filter with Water Separator	•	•	•	•	•
Coolant Recovery tank	•	•	•	•	•
Dual Element dry-type air filter with Evacuator	•	•	•	•	•
Pre Cleaner	•	•	•	•	•
Electronic Engine Control	•	•	•	•	•
Auto-Idle	•	•	•	•	•
Overheat & Low Oil Pressure Engine Protection	•	•	•	•	•
Variable Speed Radiator Cooling Fan	—	—	•	•	•
Block Heater	■	■	■	■	■
Diesel Powered Coolant Heater	■	■	■	■	■
HYDRAULIC					
Electronic Power Optimizing System (EPOS)	•	•	•	•	•
Bent Axis Piston Main Pump (Tandem)	—	—	•	•	•
Variable Axial Piston Main Pump (Tandem)	•	—	—	—	—
Cross Sensing Pump Control	•	•	•	•	•
Pilot Operated Control Valves	•	•	•	•	•
Gear Pilot Pump	•	•	•	•	•
Variable Speed Hydraulic Cooling Fan	•	•	•	•	•
Axial Piston Swing Motor	•	•	•	•	•
Spring Applied Hydraulic Release Brake	•	•	•	•	•
Axial Piston Travel Motor (High/Low, Auto)	•	•	•	•	•
Auxiliary Hydraulics, One-Way	•	•	•	•	•
Auxiliary Hydraulics, Two-Way	■	■	■	■	■
Adjustable Auxiliary Flow & Pressure, 10 Presets	•	•	•	•	•
Intelligent Floating Boom	■	■	■	■	■
Boom Lock Valve	■	■	■	■	■
CABIN					
Steel, All-Weather & Sound Suppressed	•	•	•	•	•
ROPS (ISO 12117-2:2008)	•	•	•	•	•
Viscous Mount	•	•	•	•	•
Front Window with Wiper/Washer	•	•	•	•	•
Tinted Safety Glass	•	•	•	•	•
Skylight	•	•	•	•	•
Visor, Front Window and Skyliight	•	•	•	•	•
Pull Up Type Top Front Window	•	•	•	•	•
Removable Lower Front Window with Storage Behind Seat	•	•	•	•	•
Adjustable Sliding Side Door Windows	•	•	•	•	•
Defrost, Front Window	•	•	•	•	•
Lockable Doors	•	•	•	•	•
Seat - Heated - Air Suspension - 2" (51 mm) Seat Belt	•	•	•	•	•
3" (76 mm) Seat Belt	■	■	■	■	■
Control Stands - Height Adjustable - Mounted to Seat Base	•	•	•	•	•
Storage for Operator's Manuals	•	•	•	•	•
Mirrors	•	•	•	•	•
Fully Automatic HVAC w/ ambient temperature sensor	•	•	•	•	•
7" Multi-Function LCD	•	•	•	•	•
Cigarette Lighter	•	•	•	•	•
AM/FM Stereo with CD Player & MP3 port	•	•	•	•	•
Speakers (2)	•	•	•	•	•
Antenna, Roof Mounted	•	•	•	•	•
Emergency Breakout Tool	•	•	•	•	•
Hot/Cold Beverage Compartment	•	•	•	•	•
Power Socket, 12V	•	•	•	•	•
Beverage Holder	•	•	•	•	•
Interior Light	•	•	•	•	•
Coat Hanger	•	•	•	•	•
Rain Shield	■	■	■	■	■
Guard, FOGS	■	■	■	■	■
Guard, front window guard	■	■	■	■	■
Vandalism Window Covers	■	■	■	■	■
ELECTRICAL					
Alternator - 12V, 50 Amp	•	•	—	—	—
Alternator - 12V, 80 Amp	■	■	•	•	•
2 x 12V Batteries, 150 AH Reserve Capacity	•	•	•	•	•
Blade Type Fuse Panel	•	•	•	•	•
Main Circuit Breaker	•	•	•	•	•
Light, Work (Halogen): Machine (2), Boom (2)	•	•	•	•	•
Light, Work (Halogen): Cabin (2)	■	■	■	■	■

	DX300LC-3	DX350LC-3	DX420LC-3	DX490LC-3	DX530LC-3
ELECTRICAL (CONT.)					
Light, Work (Halogen): Cabin (4 Front, 2 Rear)	■	■	■	■	■
Rotating Beacon	■	■	■	■	■
Hour Meter	•	•	•	•	•
Engine Restart Prevention System	•	•	•	•	•
Rear View Camera	•	•	•	•	•
Laptop Service Port	•	•	•	•	•
Self-Diagnostics System	•	•	•	•	•
Telematics	•	•	•	•	•
DISPLAY MONITOR & WARNINGS					
Buzzer	•	•	•	•	•
- Engine Oil Pressure	•	•	•	•	•
- Coolant Temperature	•	•	•	•	•
Gauges	•	•	•	•	•
- Engine Coolant Temperature	•	•	•	•	•
- Fuel Level	•	•	•	•	•
- Hydraulic Oil Temperature	•	•	•	•	•
- Engine RPM	•	•	•	•	•
- Battery Voltage	•	•	•	•	•
- Hydraulic Pump Pressure	•	•	•	•	•
- ECO	•	•	•	•	•
- Digital Clock	•	•	•	•	•
Warning & Indicator Lights	•	•	•	•	•
- Hydraulic Oil Temperature - High	•	•	•	•	•
- Fuel Level - Low	•	•	•	•	•
- Air Filter - Clogged	•	•	•	•	•
- Hydraulic Pilot Filter - Clogged	•	•	•	•	•
- Hydraulic Return Filter - Clogged	•	•	•	•	•
- Check Engine	•	•	•	•	•
- Engine Oil Pressure - Low	•	•	•	•	•
- Hydraulic Charge Pressure - Low	•	•	•	•	•
- Engine Pre-Heat Engaged	•	•	•	•	•
- Coolant Temperature - High	•	•	•	•	•
- Work Lights On	•	•	•	•	•
- Water in Fuel	•	•	•	•	•
- D PF Regeneration	•	•	•	•	•
- DPF High Temperature Exhaust	•	•	•	•	•
Swing Alarm	■	■	■	■	■
Travel Alarm	•	•	•	•	•
UNDERCARRIAGE					
Track Guards and Chains with Adjusters	•	•	•	•	•
Track Rollers, Upper (2 Each Side)	•	•	•	—	—
Track Rollers, Lower (3 Each Side)	—	—	—	•	•
Track Rollers, Lower (9 Each Side)	•	•	•	•	•
In-Shoe Motor Protection	•	•	•	•	•
Shoes, Triple Grouser - 700 mm (48 Each Side)	■	■	—	—	—
Shoes, Triple Grouser - 750 mm (48 Each Side)	—	—	■	■	■
Shoes, Triple Grouser - 800 mm (48 Each Side)	•	•	•	■	■
Shoes, Triple Grouser - 850 mm (48 Each Side)	■	■	—	—	—
Shoes, Triple Grouser - 900 mm (48 Each Side)	—	■	■	•	•
Shoes	48	48	50	53	53
CONTROLS					
Joystick Controls	•	•	•	•	•
Pattern Control Change Valve (SAE, ISO)	•	•	•	•	•
Joystick Attachment Control Switches/Buttons	•	•	•	•	•
- One-way	•	•	•	•	•
- Two-way	•	•	•	•	•
- Power Boost	•	•	•	•	•
Control Stands	•	•	•	•	•
- Height Adjustable	•	•	•	•	•
- Sliding (Fore/Aft)"	•	•	•	•	•
Engine Speed Control Dial	•	•	•	•	•
Travel Pedals with Hand Levers	•	•	•	•	•
Straight Travel Pedal	■	■	■	■	■
Switches, Console mounted	•	•	•	•	•
- Starter (Key)	•	•	•	•	•
- Travel Speed Selector	•	•	•	•	•
- Work Light	•	•	•	•	•
- DPF Regeneration	•	•	•	•	•
- Auxiliary Mode Switch	•	•	•	•	•
- Emergency Stop Switch	•	•	•	•	•
Power Mode (P+, P, S, E)	•	•	•	•	•
Work Mode (Digging, Lifting, Breaker, Shear)	•	•	•	•	•
Jog Dial Display Control	•	•	•	•	•
Wiper Control Panel	•	•	•	•	•
Audio Control Panel	•	•	•	•	•
OTHER					
Centralized Lubrication	•	•	•	•	•
- Boom	•	•	•	•	•
- Arm	•	•	•	•	•
- Swing Bearing	•	•	•	•	•
Handrails	•	•	•	•	•
Skid-Resistant Steps	•	•	•	•	•
Manuals	•	•	•	•	•
- Operations & Maintenance	•	•	•	•	•
- Parts	•	•	•	•	•
- AEM Safety Manual	•	•	•	•	•
Telematics, 1 Year Subscription	•	•	•	•	•
Vandalism Protection	•	•	•	•	•
- Lockable panels	•	•	•	•	•
- Lockable fluid fill points	•	•	•	•	•
48-Hour Parts Guarantee	•	•	•	•	•
Air Compressor	■	■	■	■	■



Standard Equipment based on Standard Configuration

Specifications

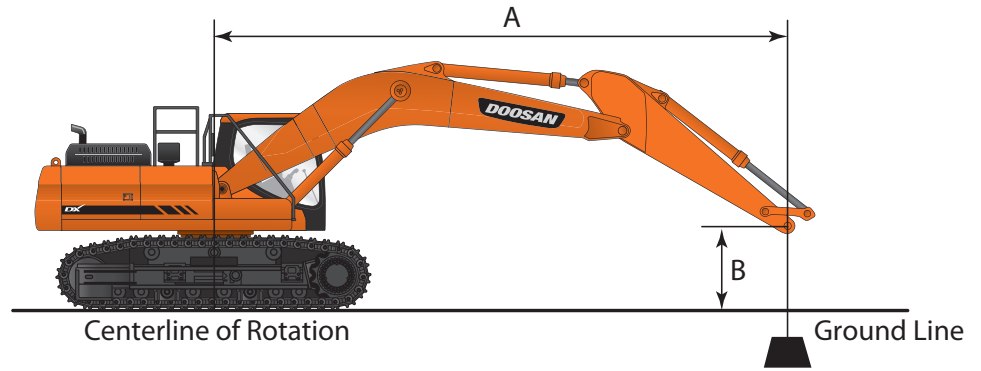











Lifting Capacity

















DX300LC-3

Track Width: 11'2" (3400 mm)	Bucket: None	 Load Radius Over Front  Load Radius Over Side
Boom: 20'6" (6245 mm)	Track Shoe Width: 2'7" (800 mm)	
Arm: 10'2" (3100 mm)	Counter Weight: 11,680 lb (5300 kg)	Unit: 1000 lb (1000 kg)

Feet

B ft \ A ft	5		10		15		20		25		MAX REACH		A ft		
															
25													*12.0	*12.0	23.53
20							*15.03	*15.03	*14.98	12.64			*11.49	11.22	26.74
15					*20.59	*20.59	*17.39	*17.39	*15.91	12.33			*11.49	9.78	28.72
10					*27.24	25.24	*20.56	16.53	*17.50	11.86			*11.90	9.03	29.73
5					*32.88	23.51	*23.62	15.65	18.35	11.4			*12.76	8.76	29.87
0 (GROUND)					*35.69	22.69	25.17	15.07	17.97	11.06			*14.25	8.93	29.16
-5	*19.22	*19.22	*27.76	*27.76	*36.08	22.48	24.88	14.82	17.81	10.92			15.56	9.62	27.51
-10	*31.35	*31.35	*43.01	*43.01	*34.39	22.69	24.97	14.89					18.21	11.21	24.77
-15			*41.51	*41.51	*29.85	23.32	*21.70	15.42					*20.91	14.98	20.46

Metric

B m \ A m	1.5		3		4.5		6		7.5		9		MAX REACH		A mm
															
7.5													*5.41	*5.41	7.27
6							*6.88	6.88	*6.80	5.88			*5.20	5.03	8.2
4.5					*9.58	9.58	*8.02	8.02	*7.28	5.73			*5.22	4.41	8.78
3					*12.68	11.69	*9.5	7.66	*8.04	5.51	*5.96	4.14	*5.41	4.09	9.07
1.5					*15.25	10.9	*10.91	7.26	8.52	5.29	6.47	4.05	*5.79	3.97	9.1
0 (GROUND)					*16.49	10.54	11.7	6.99	8.34	5.13			*6.46	4.05	8.89
-1.5	*8.61	*8.61	*12.28	*12.28	*16.64	10.45	11.57	6.87	8.26	5.06			7.04	4.36	8.4
-3	*14.00	*14.00	*18.97	*18.97	*15.88	10.54	11.61	6.9	8.33	5.12			8.21	5.05	7.58
-4.5			*19.26	*19.26	*13.88	10.82	*10.22	7.12					*9.47	6.66	6.31

*Hydraulically Limited

- Load point is the end of the arm.
- Capacities marked with an asterisk (*) are limited by hydraulic capacities.
- Lift capacities shown do not exceed 75% of minimum tipping loads or 87% of hydraulic capacities.
- The least stable position is over the side.
- The total mass of machine includes the mass of the boom, arm, counterweight, all operating fluids and a 75 kg operator.
- Lift capacities are in compliance with ISO 10567.



Lifting Capacity

DX300LC-3















Track Width: 11'4" (3450 mm)
 Boom: 20'6" (6245 mm)
 Arm: 12'4" (3750 mm)

Bucket: None
 Track Shoe Width: 2'9" (850 mm)
 Counter Weight: 13,889 lb (6300 kg)















Unit: 1000 lb (1000 kg)

 Load Radius Over Front
 Load Radius Over Side

Feet

B ft	A ft	5		10		15		20		25		30		MAX REACH		A ft
																
25										*11.40	*11.40			*9.93	*9.93	25.69
20										*13.27	12.95			*9.62	*9.62	28.65
15								*15.46	*15.46	*14.45	12.57	*11.22	9.25	*9.68	8.97	30.51
10						*24.10	24.10	*18.77	16.9	*16.22	12.05	14.30	9.02	*10.05	8.31	31.47
5						*30.43	24.08	*22.14	15.9	18.13	11.51	14	8.74	*10.78	8.06	31.60
0 (GROUND)				*19.39	*19.39	*34.41	22.88	*24.77	15.17	18.03	11.08	13.76	8.53	*12.00	8.16	30.93
-5	*19.00	*19.00	*27.64	*27.64	*35.88	22.41	24.88	14.77	17.76	10.83				*14.04	8.68	29.39
-10	*28.16	*28.16	*38.86	*38.86	*35.22	22.44	24.81	14.71	17.75	10.83				16.07	9.88	26.84
-15	*39.46	*39.46	*45.90	45.88	*32.11	22.88	*23.86	15.01						*19.93	12.51	22.92
-20			*34.72	*34.72	*24.38	23.94								*21.37	20.44	16.70

Metric

B m	A m	1.5		3		4.5		6		7.5		9		MAX REACH		A mm
																
7.5										*5.64	*5.64			*4.48	*4.48	7.92
6										*6.03	6.03			*4.36	*4.36	8.78
4.5								*7.12	*7.12	*6.61	5.84	*5.69	4.31	*4.39	4.05	9.32
3						*11.21	*11.21	*8.67	7.84	*7.45	5.59	6.65	4.19	*4.57	3.77	9.60
1.5						*14.11	11.17	*10.23	7.37	*8.34	5.34	6.51	4.06	*4.90	3.65	9.63
0 (GROUND)				*8.56	*8.56	*15.91	10.62	*11.43	7.03	8.37	5.14	6.39	3.96	*5.44	3.70	9.43
-1.5	*8.53	*8.53	*12.26	*12.26	*16.56	10.42	11.57	6.85	8.24	5.02				*6.35	3.93	8.97
-3	*12.59	*12.59	*17.19	*17.19	*16.26	10.43	11.54	6.82	8.23	5.01				7.25	4.46	8.21
-4.5	*17.56	*17.56	*21.26	*21.26	*14.89	10.62	*11.10	6.95						*9.01	5.60	7.05
-6			*16.38	*16.38	*11.59	11.08								*9.66	8.85	5.24

*Hydraulically Limited

Specifications



Lifting Capacity

DX300LC-3 SLR











Track Width: 11'4" (3450 mm) STD TRACK
 Boom: 32'10" (10 000 mm)
 Arm: 23'0" (7000 mm)

Bucket: None
 Track Shoe Width: 2'9" (850 mm)
 Counter Weight: 13,889 lb (6300 kg)











Unit: 1000 lb (1000 kg)

 Load Radius Over Front
 Load Radius Over Side

Feet

B ft \ A ft	5		10		15		20		25	
										
40										
35										
30										
25										
20										
15										
10					*20.01	*20.01	*14.12	*14.12	*11.23	*11.23
5					*14.90	*14.90	*17.10	14.88	*13.11	11.16
0 (GROUND)			*7.35	*7.35	*13.08	*13.08	*19.43	13.4	*14.75	10.15
-5	*8.51	*8.51	*9.72	*9.72	*14.02	*14.02	*20.97	12.53	*16.01	9.44
-10	*10.71	*10.71	*12.14	*12.14	*15.96	*15.96	*21.83	12.09	16.08	9.01
-15	*13.01	*13.01	*14.70	*14.70	*18.50	*18.33	*22.13	11.96	15.85	8.81
-20	*15.46	*15.46	*17.50	*17.50	*21.58	*18.65	*21.96	12.06	15.84	8.79
-25	*18.13	*18.13	*20.63	*20.63	*25.33	*19.18	*21.26	12.33	16.01	8.95
-30	*21.08	*21.08	*24.26	*24.26	*25.81	*19.94	*19.93	12.8	*16.07	9.28
-35			*28.64	*28.64	*22.64	*20.99	*17.71	13.51	*14.33	9.82
-40					*17.70	*17.70	*13.95	*13.95	*10.97	10.74

Metric

B m \ A mm	1.5		3		4.5		6		7.5	
										
12										
10.5										
9										
7.5										
6										
4.5										
3					*9.36	*9.36	*6.56	*6.56	*5.20	*5.20
1.5					*6.44	*6.44	*7.93	6.83	*6.07	5.13
0 (GROUND)			*3.28	*3.28	*5.76	*5.76	*8.99	6.16	*6.82	4.67
-1.5	*3.85	*3.85	*4.35	*4.35	*6.22	*6.22	*9.96	5.76	*7.39	4.34
-3	*4.82	*4.82	*5.43	*5.43	*7.09	*7.09	*10.08	5.57	7.41	4.15
-4.5	*5.85	*5.85	*6.58	*6.58	*8.22	*8.22	*10.22	5.51	7.31	4.05
-6	*6.93	*6.93	*7.81	*7.81	*9.58	*8.60	*10.14	5.55	7.30	4.04
-7.5	*8.11	*8.11	*9.19	*9.19	*11.21	*8.84	*9.83	5.67	7.38	4.11
-9	*9.41	*9.41	*10.78	*10.78	*11.98	*9.18	*9.25	5.88	*7.46	4.25
-10.5			*12.68	*12.68	*10.60	*9.64	*8.29	6.19	*7.62	4.49
-12					*8.48	*8.48	*6.70	*6.65	*5.34	4.87

*Hydraulically Limited



30		35		40		45		50		MAX REACH		
												A ft
										*3.25	*3.25	41.69
						*3.33	*3.33			*3.12	*3.12	45.23
				*5.88	*5.88	*5.24	*5.24			*3.04	*3.04	48.05
				*6.17	*6.17	*6.18	5.53	*3.20	*3.20	*3.02	*3.02	50.18
				*6.60	*6.60	*6.46	5.35	*4.69	4.23	*3.04	*3.04	51.74
*8.29	*8.29	*7.61	*7.61	*7.14	6.39	*6.83	5.12	*5.69	4.1	*3.10	*3.10	52.79
*9.55	9.51	*8.48	7.49	*7.76	6	*7.27	4.85	*6.46	3.93	*3.20	*3.20	53.34
*10.82	8.7	*9.38	6.94	*8.40	5.62	*7.73	4.59	6.51	3.76	*3.35	3.28	53.42
*11.99	8	*10.22	6.45	8.94	5.27	7.49	4.35	6.35	3.61	*3.56	3.23	53.02
12.88	7.46	10.41	6.05	8.63	4.99	7.28	4.15	6.22	3.48	*3.84	3.24	52.15
12.49	7.1	10.11	5.77	8.41	4.78	7.13	4.01	*5.50	3.41	*4.22	3.34	50.75
12.27	6.9	9.93	5.6	8.28	4.66	7.06	3.95			*4.74	3.53	48.82
12.22	6.85	9.89	5.56	8.27	4.64	7.1	3.98			*5.50	3.86	46.24
12.33	6.95	9.98	5.65	8.39	4.76					*6.66	4.38	42.95
12.61	7.21	10.25	5.9							*8.69	5.24	38.74
*11.69	7.7									*10.11	6.8	33.24
										*10.59	10.4	25.64

9		10.5		12		13.5		15		MAX REACH		
												A mm
										*1.47	*1.47	12.85
						*1.88	*1.88			*1.41	*1.41	13.90
						*2.58	*2.58			*1.38	*1.38	14.71
				*2.81	*2.81	*2.81	2.57	*1.84	*1.84	*1.37	*1.37	15.34
				*3.02	*3.02	*2.95	2.48	*2.42	1.98	*1.38	*1.38	15.80
*3.83	*3.83	*3.50	*3.50	*3.28	2.95	*3.12	2.37	*2.84	1.91	*1.41	*1.41	16.10
*4.41	4.38	*3.91	3.46	*3.56	2.77	*3.33	2.25	*3.10	1.83	*1.46	*1.46	16.26
*5.00	4.00	*4.32	3.20	*3.86	2.60	*3.55	2.13	3.01	1.75	*1.52	1.47	16.28
*5.53	3.68	*4.71	2.97	4.12	2.43	3.46	2.01	2.93	1.67	*1.62	1.45	16.16
5.94	3.43	4.80	2.79	3.98	2.30	3.36	1.92	2.87	1.61	*1.74	1.46	15.90
5.75	3.27	4.66	2.66	3.87	2.20	3.28	1.85	2.83	1.57	*1.91	1.50	15.49
5.65	3.17	4.58	2.58	3.81	2.14	3.25	1.82			*2.14	1.58	14.91
5.63	3.15	4.55	2.56	3.80	2.13	3.26	1.83			*2.47	1.72	14.15
5.67	3.19	4.59	2.59	3.85	2.18					*2.978	1.95	13.18
5.79	3.30	4.7	2.69							*3.83	2.31	11.94
*5.52	3.51									*4.56	2.96	10.33
										*4.78	4.38	8.16















Specifications

Lifting Capacity















DX350LC-3

Track Width: 11'5" (3480 mm) STD TRACK	Bucket: None	 Load Radius Over Front
Boom: 21'4" (6500 mm)	Track Shoe Width: 2'7" (800 mm)	 Load Radius Over Side
Arm: 10'6" (3200 mm)	Counter Weight: 15,653 lb (7100 kg)	Unit: 1,000 lb (1000 kg)

Feet

B ft \ A ft	5		10		15		20		25		30		MAX REACH		A ft
															
25									*17.50	16.23			*17.25	16.15	25.06
20									*18.08	16.13			*16.76	13.2	28.07
15					*27.18	*27.18	*21.99	*21.99	*19.36	15.64			*16.91	11.62	29.95
10					*34.63	31.72	*25.51	20.84	*21.15	15	17.05	11.32	16.27	10.79	30.89
5					*40.11	29.58	*28.62	19.71	21.99	14.39	16.73	11.03	15.93	10.5	31
0 (GROUND)					*41.97	28.67	30.09	18.99	21.5	13.95	16.51	10.83	16.3	10.69	30.28
-5			*33.87	*33.87	*41.14	28.51	29.76	18.7	21.29	13.75			17.57	11.48	28.66
-10	*39.90	*39.90	*52.13	*52.13	*38.06	28.81	*28.87	18.8	21.44	13.89			20.35	13.24	25.98
-15			*42.65	*42.65	*31.96	29.58	*23.96	19.37					*20.98	17.24	21.84

Metric

B m \ A m	1.5		3		4.5		6		7.5		9		MAX REACH		A mm
															
7.5									*8.12	7.58			*7.79	7.18	7.73
6									*8.25	7.50			*7.60	5.93	8.60
4.5					*12.65	*12.65	*10.15	*10.15	*8.89	7.26	8.07	5.40	*7.68	5.25	9.15
3					*16.12	14.69	*11.80	9.65	*9.74	6.96	7.93	5.26	7.37	4.89	9.42
1.5					*18.58	13.72	*13.23	9.13	10.21	6.67	7.77	5.12	7.22	4.76	9.45
0 (GROUND)					*19.37	13.32	13.99	8.81	9.98	6.47	7.66	5.02	7.39	4.85	9.23
-1.5			*14.99	*14.99	*18.97	13.25	13.84	8.67	9.88	6.37			7.95	5.20	8.75
-3	*17.83	*17.83	*23.40	*23.40	*17.57	13.39	*13.36	8.72	9.94	6.43			9.16	5.96	7.96
-4.5			*19.80	*19.80	*14.87	13.73	*11.25	8.96					*9.52	7.69	6.73

*Hydraulically Limited



Lifting Capacity

DX350LC-3















Track Width: 11'5" (3480 mm) STD TRACK
 Boom: 21'4" (6500 mm)
 Arm: 12'11" (3200 mm)

Bucket: None
 Track Shoe Width: 2'7" (800 mm)
 Counter Weight: 15,653 lb (7100 kg)















Unit: 1,000 lb (1000 kg)

 Load Radius Over Front
 Load Radius Over Side

Feet

B ft	A ft	5		10		15		20		25		30		MAX REACH		A ft
																
30														*13.63	*13.63	24.06
25										*15.48	*15.48			*12.59	*12.59	28.11
20										*16.02	*16.02	*14.83	11.92	*12.20	11.32	30.81
15							*19.45	*19.45	*17.51	15.83	*16.45	11.7		*12.23	10.11	32.53
10						*30.49	*30.49	*23.17	21.17	*19.51	15.1	17.08	11.32	*12.60	9.44	33.40
5						*37.14	30.06	*26.74	19.84	*21.53	14.36	16.65	10.93	*13.35	9.18	33.50
0(GROUND)				*20.86	*20.86	*40.71	28.56	*29.27	18.88	21.36	13.78	16.30	10.61	14.29	9.30	32.83
-5		*21.65	*21.65	*31.14	*31.14	*41.35	28.01	29.44	18.37	20.99	13.45	16.14	10.45	15.19	9.86	31.35
-10		*32.95	*32.95	*44.54	*44.54	*39.59	28.06	29.33	18.28	20.94	13.40			17.08	11.07	28.93
-15		*46.59	*46.59	*49.13	*49.13	*35.19	28.60	*26.50	18.61	*19.63	13.78			*19.17	13.60	25.28
-20				*36.01	*36.01	*26.43	*26.43							*18.69	*18.69	19.77

Metric

B m	A m	1.5		3		4.5		6		7.5		9		MAX REACH		A mm
																
9														*6.12	*6.12	7.47
7.5														*5.69	*5.69	8.65
6										*7.31	*7.31	7.23	5.6	*5.53	5.13	9.43
4.5										*8.04	7.4	7.51	5.48	*5.55	4.6	9.93
3						*14.18	*14.18	*10.71	9.88	*8.98	7.05	*7.99	5.3	*5.72	4.31	10.18
1.5						*17.22	14.03	*12.36	9.26	*9.92	6.71	7.79	5.11	*6.07	4.2	10.21
0(GROUND)				*9.20	*9.20	*18.81	13.36	*13.51	8.82	10	6.44	7.63	4.96	6.53	4.25	10.01
-1.5		*9.72	*9.72	*13.81	*13.81	*19.08	13.11	13.79	8.59	9.82	6.28	7.54	4.88	6.93	4.5	9.56
-3		*14.73	*14.73	*19.72	*19.72	*18.28	13.14	*13.66	8.54	9.79	6.26			7.77	5.04	8.85
-4.5		*20.73	*20.73	*22.77	*22.77	*16.32	13.38	*12.33	8.68	*9.28	6.41			*8.69	6.13	7.77
-6				*16.99	*16.99	*12.52	*12.52	*8.94	*8.94					*8.52	*8.52	6.16

*Hydraulically Limited

Specifications



Lifting Capacity

DX420LC-3















Track Width: 11'8" (3550 mm) STD TRACK
 Boom: 22' (6700 mm)
 Arm: 10'8" (3250 mm)

Bucket: None
 Track Shoe Width: 2'7" (800 mm)
 Counter Weight: 18,078 lb (8200 kg)















Unit: 1000 lb (1,000 kg)

 Load Radius Over Front
 Load Radius Over Side

Feet

B ft \ A ft	5		10		15		20		25		30		MAX REACH		A ft
															
30													20.98 *	20.98 *	22.20
25									21.58 *	20			19.41 *	18.01	26.50
20									22.15 *	19.71			18.91 *	15	29.30
15					34.96 *	34.96 *	27.62 *	26.84	23.93 *	19.03	21.89	14.17	19.08 *	13.35	31.05
10					44.18 *	38.29	31.99 *	25.23	26.19 *	18.2	21.47	13.79	19.46	12.48	31.91
5					45.18 *	35.85	35.64 *	23.87	27.68	17.45	21.04	13.4	19.12	12.18	31.97
0 (GROUND)					48.11 *	34.92	37.60 *	23.03	27.08	16.91	20.74	13.13	19.59	12.42	31.22
-5			33.05 *	33.05 *	50.14 *	34.81	37.54 *	22.72	26.82	16.68			21.1	13.33	29.60
-10	40.28 *	40.28 *	52.27 *	52.27 *	46.10 *	35.2	35.22 *	22.85	26.98	16.81			24.3	15.29	26.95
-15			50.91 *	50.91 *	38.68 *	36.1	29.46 *	23.49					24.15 *	19.6	22.91

Metric

B m \ A m	1.5		3		4.5		6		7.5		9		MAX REACH		A mm
															
9													9.42 *	9.42 *	6.92
7.5									9.77 *	9.33			8.77 *	8.03	8.15
6									10.13 *	9.16			8.57 *	6.74	8.97
4.5					16.30 *	16.30 *	12.77 *	12.44	11.00 *	8.83	10.05 *	6.6	8.66 *	6.03	9.48
3					20.57 *	17.73	14.81 *	11.69	12.07 *	8.44	9.98	6.41	8.82	5.65	9.73
1.5					18.92 *	16.63	16.48 *	11.06	12.86	8.09	9.77	6.22	8.67	5.53	9.74
0 (GROUND)					20.72 *	16.23	17.36 *	10.68	12.58	7.84	9.63	6.09	8.89	5.64	9.52
-1.5			14.63 *	14.63 *	23.10 *	16.19	17.32 *	10.54	12.46	7.73	9.6	6.06	9.55	6.03	9.03
-3	*18.00	*18.00	23.11 *	23.11 *	21.27 *	16.37	16.29 *	10.6	12.51	7.78			10.96	6.9	8.24
-4.5			23.61 *	23.61 *	17.98 *	16.77	13.79 *	10.87					10.97 *	8.75	7.06
-6													10.59 *	10.59 *	4.93



*Hydraulically Limited

Lifting Capacity















DX420LC-3

Track Width: 11'8" (3550 mm) STD TRACK
 Boom: 22' (6700 mm)
 Arm: 12'9" (3900 mm)















Bucket: None
 Track Shoe Width: 2'11" (900 mm)
 Counter Weight: 18,078 lb (10 000 kg) Unit: 1000 lb (1,000 kg)

 Load Radius Over Front
 Load Radius Over Side

Feet

B ft	A ft	5		10		15		20		25		30		MAX REACH		A ft
																
30										16.85 *	16.85 *			16.11 *	16.11 *	25.25
25										19.00 *	19.00 *			15.06 *	15.06 *	29.07
20										19.95 *	19.95 *	19.46 *	14.61	14.70 *	13.21	31.65
15								24.82 *	24.82 *	21.93 *	19.24	20.27 *	14.27	14.79 *	11.88	33.27
10						39.56 *	39.46	29.44 *	25.61	24.43 *	18.31	21.49	13.78	15.29 *	11.14	34.08
5						47.17 *	36.34	33.66 *	24.01	26.84 *	17.42	20.95	13.29	16.25 *	10.86	34.13
0 (GROUND)				20.37 *	20.37 *	50.68 *	34.74	36.43 *	22.91	26.93	16.73	20.52	12.89	17.51	11.02	33.43
-5	22.87 *	22.87 *	31.72 *	31.72 *	50.75 *	34.22	37.31 *	22.35	26.5	16.35	20.31	12.7	18.61	11.68	31.93	
-10	34.76 *	34.76 *	45.75 *	45.75 *	48.09 *	34.36	36.11 *	22.29	26.45	16.3			20.94	13.12	29.49	
-15	48.85 *	48.85 *	58.47 *	58.47 *	42.41 *	35.04	32.21 *	22.69	24.24 *	16.71			22.73 *	16.02	25.87	
-20			42.62 *	42.62 *	31.84 *	31.84 *	22.79 *	22.79 *					21.92 *	21.92 *	20.43	

Metric



B m	A m	1.5		3		4.5		6		7.5		9		MAX REACH		A mm
																
9										8.53 *	8.53 *			7.24 *	7.24 *	7.83
7.5										8.63 *	8.63 *			6.81 *	6.81 *	8.94
6										9.13 *	9.13 *	8.84 *	6.81	6.66 *	5.94	9.69
4.5								11.47 *	11.47 *	10.08 *	8.93	9.27 *	6.64	6.71 *	5.37	10.16
3						18.41 *	18.29	13.62 *	11.87	11.25 *	8.5	9.90 *	6.4	6.95 *	5.05	10.39
1.5						21.87 *	16.86	15.56 *	11.13	12.38 *	8.08	9.73	6.17	7.38 *	4.93	10.40
0 (GROUND)				8.99 *	8.99 *	22.47 *	16.14	16.82 *	10.63	12.51	7.76	9.53	5.98	7.94	5	10.19
-1.5	10.27 *	10.27 *	14.08 *	14.08 *	23.41 *	15.91	17.22 *	10.37	12.31	7.58	9.42	5.89	8.43	5.29	9.74	
-3	15.55 *	15.55 *	20.27 *	20.27 *	22.20 *	15.98	16.69 *	10.34	12.28	7.55	9.47	5.93	9.45	5.92	9.02	
-4.5	21.75 *	21.75 *	27.09 *	27.09 *	19.67 *	16.28	14.98 *	10.51	11.41 *	7.72			10.31 *	7.18	7.94	
-6			20.10 *	20.10 *	15.05 *	15.05 *	11.03 *	10.99					10.00 *	10.00 *	6.35	

*Hydraulically Limited













Specifications

Lifting Capacity













DX490LC-3

Track Width: 12'5" (3790 mm) STD TRACK	Bucket: None	 Load Radius Over Front  Load Radius Over Side
Boom: 22' (7100 mm)	Track Shoe Width: 2'11" (900 mm)	
Arm: 12'9" (3350 mm)	Counter Weight: 18,078 lb (9200 kg)	Unit: 1000 lb (1,000 kg)

Feet

B ft	10		15		20		25		30		MAX REACH		A ft
													
30							21.94 *	21.94 *			18.99 *	18.99 *	25.55
25							23.99 *	23.99 *			17.93 *	17.93 *	29.17
20							25.43 *	24.87	23.83 *	18.41	17.61 *	16.78	31.59
15			44.04 *	44.04 *	33.15 *	33.15 *	27.81 *	23.87	24.83 *	17.96	17.84 *	15.26	33.07
10			53.71 *	47.46	38.02 *	31.41	30.46 *	22.79	26.18 *	17.39	18.55 *	14.47	33.73
5			40.09 *	40.09 *	41.65 *	29.85	32.67 *	21.86	26.42	16.87	19.85 *	14.27	33.64
0 (GROUND)			49.11 *	44.45	43.23 *	28.99	33.88 *	21.25	26.04	16.52	21.94 *	14.63	32.78
-5	38.63 *	38.63 *	56.29 *	44.53	42.68 *	28.72	33.64 *	21.01	25.95	16.45	24.74	15.73	31.08
-10	59.35 *	59.35 *	51.38 *	45.1	39.81 *	28.95	31.29 *	21.17			25.89 *	17.97	28.41
-15	55.03 *	55.03 *	43.01 *	43.01 *	33.52 *	29.71					25.35 *	22.67	24.42



Metric

B m	3		4.5		6		7.5		9		MAX REACH		A mm
													
9							10.95 *	10.95 *			8.55 *	8.55 *	7.92
7.5							10.95 *	10.95 *			8.11 *	8.11 *	8.96
6							11.68 *	11.54	10.87 *	8.57	7.99 *	7.56	9.66
4.5			20.58 *	20.58 *	15.36 *	15.36 *	12.82 *	11.07	11.39 *	8.34	8.10 *	6.9	10.09
3			21.50 *	21.50 *	17.61 *	14.55	14.06 *	10.56	12.04 *	8.07	8.43 *	6.56	10.28
1.5			16.95 *	16.95 *	19.26 *	13.83	15.08 *	10.13	12.27	7.83	9.01 *	6.47	10.25
0 (GROUND)			21.31 *	20.68	19.96 *	13.45	15.63 *	9.85	12.08	7.66	9.95 *	6.64	9.99
-1.5	17.16 *	17.16 *	25.91 *	20.73	19.69 *	13.33	15.54 *	9.74	12.03	7.62	11.2	7.12	9.49
-3	26.32 *	26.32 *	23.69 *	20.99	18.40 *	13.43	14.52 *	9.81			11.74 *	8.11	8.69
-4.5	25.50 *	25.50 *	19.97 *	19.97 *	15.65 *	13.77	11.58 *	10.16			11.53 *	10.14	7.51













*Hydraulically Limited

Lifting Capacity













DX490LC-3

Track Width: 11' (3350 mm) STD TRACK	Bucket: None	 Load Radius Over Front  Load Radius Over Side
Boom: 22' (7100 mm)	Track Shoe Width: 2'11" (900 mm)	
Arm: 12'9" (3350 mm)	Counter Weight: 18,078 lb (9200 kg)	Unit: 1000 lb (1,000 kg)

Feet

B ft \ A ft	10		15		20		25		30		MAX REACH		A ft
													
30							19.79 *	19.79 *			19.15 *	19.15 *	25.11
25							23.92 *	23.07			17.99 *	17.81	28.89
20							25.24 *	22.47	23.77 *	16.54	17.62 *	15.21	31.40
15			42.97 *	42.97 *	32.66 *	30.17	27.56 *	21.51	24.71 *	16.12	17.79 *	13.72	32.95
10			53.16 *	42.1	37.57 *	28.14	30.21 *	20.44	26.05 *	15.57	18.46 *	12.92	33.70
5			39.95 *	39.6	41.37 *	26.55	32.49 *	19.51	25.65	15.04	19.69 *	12.66	33.68
0 (GROUND)			47.77 *	38.86	43.17 *	25.65	33.03	18.88	25.24	14.68	21.69 *	12.92	32.90
-5	36.71 *	36.71 *	56.63 *	38.89	42.83 *	25.34	32.71	18.6	25.12	14.57	23.72	13.81	31.29
-10	57.13 *	57.13 *	51.99 *	39.4	40.22 *	25.51	31.65 *	18.72			25.89 *	15.69	28.72
-15	56.54 *	56.54 *	44.05 *	40.42	34.37 *	26.2					25.47 *	19.57	24.89
-20											24.51 *	24.51 *	18.05

Metric



B m \ A m	3		4.5		6		7.5		9		MAX REACH		A mm
													
9							10.67 *	10.67 *			8.61 *	8.61 *	7.79
7.5							10.91 *	10.74			8.14 *	7.97	8.87
6							11.59 *	10.43	10.84 *	7.71	7.99 *	6.85	9.61
4.5			20.07 *	20.07 *	15.12 *	13.97	12.69 *	9.98	11.33 *	7.49	8.08 *	6.2	10.06
3			23.23 *	19.47	17.40 *	13.03	13.94 *	9.48	11.98 *	7.23	8.38 *	5.85	10.28
1.5			16.82 *	16.82 *	19.13 *	12.3	14.99 *	9.04	11.91	6.98	8.94 *	5.74	10.26
0 (GROUND)			20.68 *	18.07	19.93 *	11.89	15.34	8.75	11.72	6.81	9.84 *	5.86	10.03
-1.5	16.29 *	16.29 *	26.08 *	18.09	19.76 *	11.76	15.2	8.62	11.65	6.75	10.74	6.26	9.55
-3	25.33 *	25.33 *	23.97 *	18.32	18.59 *	11.83	14.68 *	8.67			11.74 *	7.08	8.78
-4.5	26.18 *	26.18 *	20.43 *	18.78	16.02 *	12.13	12.06 *	8.97			11.58 *	8.76	7.65
-6			14.23 *	14.23 *							10.33 *	10.33 *	5.94

*Hydraulically Limited













Specifications

Lifting Capacity













DX530LC-3

Track Width: 12'5" (3790 mm) STD TRACK	Bucket: None	 Load Radius Over Front  Load Radius Over Side
Boom: 23" (7100 mm)	Track Shoe Width: 2'11" (900 mm)	
Arm: 9'6" (2900 mm)	Counter Weight: 24,471 lb 11 100 kg	Unit: 1000 lb (1,000 kg)

Feet

B ft	A ft	10		15		20		25		30		MAX REACH		
														A ft
30												25.99 *	25.99 *	23.79
25								25.64 *	25.64 *			24.38 *	23.41	27.64
20						30.42 *	30.42 *	26.86 *	26.86 *	25.26 *	20.27	23.90 *	20.06	30.17
15						35.00 *	35.00 *	29.10 *	26.27	25.93 *	19.94	24.19 *	18.23	31.72
10						39.61 *	34.56	31.55 *	25.27	27.06 *	19.45	25.18 *	17.31	32.41
5						42.71 *	33.21	33.48 *	24.45	27.97 *	19	26.03 *	17.12	32.32
0 (GROUND)				43.94 *	43.94 *	43.64 *	32.55	34.30 *	23.95	28.10 *	18.75	26.50 *	17.65	31.42
-5		36.99 *	36.99 *	54.85 *	50.26	42.40 *	32.45	33.53 *	23.82			26.89 *	19.1	29.65
-10		61.36 *	61.36 *	49.17 *	49.17 *	38.71 *	32.81	30.19 *	24.14			26.89 *	22.11	26.82
-15		48.40 *	48.40 *	39.54 *	39.54 *	30.82 *	30.82 *					25.61 *	25.61 *	22.54

Metric

B m	A m	3		4.5		6		7.5		9		MAX REACH		
														A mm
9												11.69 *	11.69 *	7.38
7.5								11.68 *	11.68 *			11.03 *	10.47	8.50
6						14.06 *	14.06 *	12.34 *	12.34 *	11.49 *	9.44	10.84 *	9.03	9.23
4.5						16.22 *	16.22 *	13.41 *	12.18	11.88 *	9.26	10.99 *	8.24	9.68
3						18.35 *	16	14.56 *	11.71	12.44 *	9.02	11.44 *	7.85	9.88
1.5						19.75 *	15.39	15.45 *	11.33	12.89 *	8.81	11.81 *	7.77	9.85
0 (GROUND)				18.88 *	18.88 *	20.13 *	15.1	15.83 *	11.1	12.98 *	8.69	12.02 *	8	9.58
-1.5				25.21 *	23.39	19.56 *	15.06	15.49 *	11.04	12.31 *	8.7	12.19 *	8.65	9.05
-3		28.13 *	28.13 *	22.66 *	22.66 *	17.90 *	15.22	14.06 *	11.17			12.20 *	9.97	8.21
-4.5		22.44 *	22.44 *	18.40 *	18.40 *	14.48 *	14.48 *					11.67 *	11.67 *	6.95

*Hydraulically Limited

Lifting Capacity

DX530LC-3

Track Width: 12'5" (3790 mm) STD TRACK

Boom: 23" (7100 mm)

Arm: 12'9" (3350 mm)

Bucket: None

Track Shoe Width: 2'11" (900 mm)

Counter Weight: 24,471 lb 11 100 kg

Unit: 1000 lb (1,000 kg)



Load Radius Over Front



Load Radius Over Side

Feet

B ft \ A ft	10		15		20		25		30		MAX REACH		A ft
30							21.94 *	21.94 *			18.99 *	18.99 *	25.55
25							23.99 *	23.99 *			17.93 *	17.93 *	29.17
20							25.43 *	25.43 *	23.83 *	23.1	17.61 *	17.61 *	31.59
15			44.04 *	44.04 *	33.15 *	33.15 *	27.81 *	27.81 *	24.83 *	22.64	17.84 *	17.84 *	33.07
10			53.71 *	53.71 *	38.02 *	38.02 *	30.46 *	28.83	26.18 *	22.06	18.55 *	18.46	33.73
5			40.09 *	40.09 *	41.65 *	38.29	32.67 *	27.87	27.36 *	21.53	19.85 *	18.26	33.64
0 (GROUND)			49.11 *	49.11 *	43.23 *	37.4	33.88 *	27.25	27.88 *	21.17	21.94 *	18.76	32.78
-5	38.63 *	38.63 *	56.29 *	56.29 *	42.68 *	37.13	33.64 *	27	27.07 *	21.09	25.39 *	20.16	31.08
-10	59.35 *	59.35 *	51.38 *	51.38 *	39.81 *	37.36	31.29 *	27.17			25.89 *	22.98	28.41
-15	55.03 *	55.03 *	43.01 *	43.01 *	33.52 *	33.52 *					25.35 *	25.35 *	24.42

Metric



B m \ A m	3		4.5		6		7.5		9		MAX REACH		A mm
9							10.95 *	10.95 *			8.55 *	8.55 *	7.92
7.5							10.95 *	10.95 *			8.11 *	8.11 *	8.96
6							11.68 *	11.68 *	10.87 *	10.75	7.99 *	7.99 *	9.66
4.5			20.58 *	20.58 *	15.36 *	15.36 *	12.82 *	12.82 *	11.39 *	10.51	8.10 *	8.10 *	10.09
3			21.50 *	21.50 *	17.61 *	17.61 *	14.06 *	13.37	12.04 *	10.24	8.43 *	8.37	10.28
1.5			16.95 *	16.95 *	19.26 *	17.76	15.08 *	12.92	12.60 *	9.98	9.01 *	8.28	10.25
0 (GROUND)			21.31 *	21.31 *	19.96 *	17.36	15.63 *	12.64	12.86 *	9.81	9.95 *	8.51	9.99
-1.5	17.16 *	17.16 *	25.91 *	25.91 *	19.69 *	17.24	15.54 *	12.52	12.56 *	9.77	11.48 *	9.13	9.49
-3	26.32 *	26.32 *	23.69 *	23.69 *	18.40 *	17.35	14.52 *	12.59			11.74 *	10.37	8.69
-4.5	25.50 *	25.50 *	19.97 *	19.97 *	15.65 *	15.65 *	11.58 *	11.58 *			11.53 *	11.53 *	7.51

*Hydraulically Limited













Specifications

Lifting Capacity













DX530LC-3

Track Width: 13'9" (4200 mm) STD TRACK	Bucket: None	 Load Radius Over Front
Boom: 36'1" (11000 mm)	Track Shoe Width: 2'11" (900 mm)	 Load Radius Over Side
Arm: 26'3" (8000 mm)	Counter Weight: 24,471 lb 11 100 kg	Unit: 1000 lb (1,000 kg)













Feet















B ft \ A ft	5		10		15		20		25		30	
												
40												
35												
30												
25												
20												
15												
10					29.27 *	29.27 *	26.25 *	26.25 *	20.36 *	20.36 *	16.89 *	16.89 *
5					18.78 *	18.78 *	30.55 *	30.55 *	23.15 *	23.15 *	18.81 *	18.81 *
0 (GROUND)			11.46 *	11.46 *	18.24 *	18.24 *	32.47 *	31.91	25.42 *	23.8	20.47 *	18.73
-5	13.31 *	13.31 *	14.88 *	14.88 *	20.17 *	20.17 *	31.00 *	30.48	27.04 *	22.57	21.78 *	17.76
-10	16.51 *	16.51 *	18.36 *	18.36 *	23.14 *	23.14 *	32.53 *	29.77	28.02 *	21.82	22.68 *	17.11
-15	19.84 *	19.84 *	22.01 *	22.01 *	26.75 *	26.75 *	35.69 *	29.55	28.39 *	21.46	23.15 *	16.74
-20	23.35 *	23.35 *	25.93 *	25.93 *	30.96 *	30.96 *	35.52 *	29.68	28.20 *	21.4	23.17 *	16.6
-25	27.12 *	27.12 *	30.24 *	30.24 *	35.86 *	35.86 *	34.14 *	30.09	27.41 *	21.59	22.68 *	16.69
-30	31.26 *	31.26 *	35.10 *	35.10 *	41.12 *	41.12 *	31.96 *	30.77	25.93 *	22.02	21.58 *	16.99
-35	35.89 *	35.89 *	40.75 *	40.75 *	36.41 *	36.41 *	28.74 *	28.74 *	23.54 *	22.72	19.64 *	17.54
-40			39.69 *	39.69 *	29.87 *	29.87 *	24.03 *	24.03 *	19.80 *	19.80 *	16.35 *	16.35 *

Metric

B m \ A m	1.5		3		4.5		6		7.5		9	
												
12												
10.5												
9												
7.5												
6												
4.5												
3					12.26 *	12.26 *	12.21 *	12.21 *	9.44 *	9.44 *	7.81 *	7.81 *
1.5					8.19 *	8.19 *	14.17 *	14.17 *	10.72 *	10.72 *	8.69 *	8.69 *
0 (GROUND)			5.14 *	5.14 *	8.07 *	8.07 *	14.15 *	14.15 *	11.76 *	11.02	9.46 *	8.68
-1.5	6.02 *	6.02 *	6.68 *	6.68 *	8.97 *	8.97 *	13.63 *	13.63 *	12.49 *	10.46	10.06 *	8.23
-3	7.44 *	7.44 *	8.23 *	8.23 *	10.31 *	10.31 *	14.36 *	13.83	12.93 *	10.12	10.47 *	7.93
-4.5	8.92 *	8.92 *	9.86 *	9.86 *	11.91 *	11.91 *	15.77 *	13.73	13.11 *	9.96	10.69 *	7.76
-6	10.48 *	10.48 *	11.59 *	11.59 *	13.77 *	13.77 *	16.40 *	13.79	13.02 *	9.93	10.70 *	7.7
-7.5	12.15 *	12.15 *	13.50 *	13.50 *	15.92 *	15.92 *	15.79 *	13.97	12.68 *	10.01	10.49 *	7.73
-9	13.98 *	13.98 *	15.63 *	15.63 *	18.47 *	18.47 *	14.82 *	14.27	12.02 *	10.2	10.01 *	7.86
-10.5	16.01 *	16.01 *	18.09 *	18.09 *	17.00 *	17.00 *	13.41 *	13.41 *	10.98 *	10.5	9.18 *	8.1
-12			18.89 *	18.89 *	14.14 *	14.14 *	11.36 *	11.36 *	9.38 *	9.38 *	7.80 *	7.80 *
-13.5									6.78 *	6.78 *		

*Hydraulically Limited

35		40		45		50		55		MAX REACH		
												A ft
						6.51 *	6.51 *			6.34 *	6.34 *	50.19
						9.09 *	9.09 *			6.21 *	6.21 *	53.05
						9.39 *	9.39 *	6.57 *	6.57 *	6.17 *	6.17 *	55.31
						9.68 *	9.68 *	8.65 *	8.65 *	6.19 *	6.19 *	57.05
				10.52 *	10.52 *	10.08 *	10.08 *	9.79 *	8.68	6.28 *	6.28 *	58.32
		12.07 *	12.07 *	11.20 *	11.20 *	10.57 *	10.1	10.11 *	8.44	6.44 *	6.44 *	59.12
14.64 *	14.64 *	13.07 *	13.07 *	11.94 *	11.61	11.10 *	9.71	10.48 *	8.17	6.66 *	6.66 *	59.49
16.00 *	16.00 *	14.07 *	13.27	12.68 *	11.07	11.64 *	9.33	10.86 *	7.9	6.97 *	6.84	59.44
17.24 *	15.2	14.99 *	12.59	13.37 *	10.58	12.15 *	8.97	10.91	7.66	7.37 *	6.79	58.96
18.26 *	14.47	15.78 *	12.04	13.96 *	10.17	12.34	8.67	10.7	7.47	7.90 *	6.85	58.04
19.01 *	13.94	16.38 *	11.62	14.05	9.85	12.11	8.46	10.57	7.34	8.59 *	7.03	56.66
19.45 *	13.61	16.27	11.36	13.84	9.66	11.98	8.33			9.51 *	7.35	54.79
19.39	13.47	16.15	11.24	13.78	9.59	11.98	8.34			10.79 *	7.87	52.37
19.17 *	13.51	16.2	11.29	13.87	9.68					12.37	8.65	49.33
18.25 *	13.76	15.54 *	11.53	13.10 *	9.97					12.83 *	9.85	45.51
16.49 *	14.24	13.65 *	12.04							13.19 *	11.78	40.77
										13.36 *	13.36 *	34.61

10.5		12		13.5		15		16.5		18		18		MAX REACH	
														A ft	
						3.50 *	3.50 *					2.87 *	2.87 *	15.41	
						4.20 *	4.20 *					2.81 *	2.81 *	16.25	
						4.27 *	4.27 *	3.54 *	3.54 *			2.80 *	2.80 *	16.92	
						4.42 *	4.42 *	4.33 *	4.16			2.81 *	2.81 *	17.43	
				4.83 *	4.83 *	4.61 *	4.61 *	4.47 *	4.06			2.85 *	2.85 *	17.79	
		5.55 *	5.55 *	5.15 *	5.15 *	4.84 *	4.71	4.62 *	3.94	2.99 *	2.99 *	2.92 *	2.92 *	18.03	
6.75 *	6.75 *	6.02 *	6.02 *	5.49 *	5.4	5.10 *	4.52	4.80 *	3.81	3.37 *	3.22	3.03 *	3.03 *	18.13	
7.39 *	7.39 *	6.48 *	6.16	5.83 *	5.14	5.35 *	4.34	4.98 *	3.69	3.48 *	3.14	3.16 *	3.1	18.11	
7.95 *	7.05	6.91 *	5.84	6.16 *	4.91	5.59 *	4.17	5.07	3.57			3.34 *	3.08	17.97	
8.43 *	6.71	7.28 *	5.59	6.43 *	4.72	5.73	4.03	4.97	3.48			3.58 *	3.11	17.70	
8.77 *	6.46	7.55 *	5.39	6.52	4.58	5.62	3.93	4.91	3.41			3.88 *	3.18	17.29	
8.98 *	6.31	7.55	5.27	6.42	4.48	5.56	3.87	4.88	3.39			4.29 *	3.33	16.73	
8.99	6.24	7.49	5.21	6.38	4.44	5.55	3.86					4.85 *	3.55	16.02	
8.87 *	6.26	7.5	5.23	6.41	4.47	5.61	3.92					5.57	3.89	15.11	
8.48 *	6.36	7.25 *	5.33	6.17 *	4.59							5.80 *	4.4	14.00	
7.74 *	6.57	6.48 *	5.53									5.97 *	5.23	12.60	
6.37 *	6.37 *											6.06 *	6.06 *	10.82	
												5.88 *	5.88 *	8.39	



WHO IS DOOSAN?

Doosan is the fifth largest construction equipment manufacturer in the world with a heritage that goes back more than 115 years. We deliver solid machines, unsurpassed customer service and an expanding dealer network plus our unrivaled 48-hour parts guarantee.

Doosan Delivers

www.doosanequipment.com/HEX

1.877.613.7970



Printed on 10% recycled paper

Doosan and the Doosan logo are registered trademarks of Doosan Corp. in the United States and various other countries around the world. ©2013 Doosan Infracore Construction Equipment America. All rights reserved.