

**CLAAS Lexion 700 Series - Steering
Ready Combine SmarTrax™
Installation Manual**

P/N 016-5030-047 Rev. B

09/15

E26478

Chapter 1	<i>Important Safety Information</i>	1
	Hydraulic Safety	2
	Electrical Safety	2
Chapter 2	<i>Introduction</i>	3
	Preparing for Installation	3
	Recommendations	4
	Point of Reference	4
	Updates	4
	Kit Contents	5
Chapter 3	<i>Wheel Angle Sensor Installation</i>	9
	Assemble the Wheel Angle Sensor (WAS)	9
	Single Steering Cylinder Models	9
	Dual Steering Cylinder Models	9
	Mount the WAS	10
	Single Steering Cylinder Models	10
	Dual Steering Cylinder Models	12
Chapter 4	<i>Cab Component Installation</i>	15
	Install the SmarTrax Node	15
	Mount the SmarTrax Node	15
	Node Mounting Locations	16
	Install the Foot Switch	16
	Install the Road Switch	17
	Install the Node Harness	18
	Install the Valve Harness	19
	Install the Chassis Cable - SmarTrax-Only Systems (If Applicable)	24
	Connect SmarTrax to an Existing SmartYield™ Pro (If Applicable)	24
	Calibrate the SmarTrax System	24
	System Diagrams	25

CHAPTER

1

Important Safety Information

NOTICE

Read this manual and the operation and safety instructions included with your implement and/or controller carefully before installing the SmarTrax™ system.

- Follow all safety information presented within this manual.
- If you require assistance with any portion of the installation or service of your Raven equipment, contact your local Raven dealer for support.
- Follow all safety labels affixed to the SmarTrax system components. Be sure to keep safety labels in good condition and replace any missing or damaged labels. To obtain replacements for missing or damaged safety labels, contact your local Raven dealer.

When operating the machine after installing SmarTrax, observe the following safety measures:

- Be alert and aware of surroundings.
- Do not operate SmarTrax or any agricultural equipment while under the influence of alcohol or an illegal substance.
- Remain in the operator's position in the machine at all times when SmarTrax is engaged.
- Disable SmarTrax when exiting the operator's seat and machine.
- Do not drive the machine with SmarTrax enabled on any public road.
- Determine and remain a safe working distance from other individuals. The operator is responsible for disabling SmarTrax when the safe working distance has diminished.
- Ensure SmarTrax is disabled prior to starting any maintenance work on SmarTrax or the machine.

 **WARNING**

- When starting the machine for the first time after installing SmarTrax, be sure that all persons stand clear in case a hose has not been properly tightened.
- The machine must remain stationary and switched off during SmarTrax installation or maintenance.

 **CAUTION**

Hydraulic Safety

- Raven Industries recommends that appropriate protective equipment be worn at all times when working on the hydraulic system.
- Never attempt to open or work on a hydraulic system with the equipment running. Care should always be taken when opening a system that has been previously pressurized.
- When disconnecting the hydraulic hoses or purging is required, be aware that the hydraulic fluid may be extremely hot and under high pressure. Caution must be exercised.
- Any work performed on the hydraulic system must be done in accordance with the machine manufacturer's approved maintenance instructions.
- When installing SmarTrax hydraulics or performing diagnostics, maintenance, or routine service, ensure that precautions are taken to prevent any foreign material or contaminants from being introduced into the machine's hydraulic system. Objects or materials that are able to bypass the machine's hydraulic filtration system will reduce performance and possibly damage the SmarTrax valve.

Electrical Safety

- Always verify that the power leads are connected to the correct polarity as marked. Reversing the power leads could cause severe damage to the equipment.
- Ensure that the power cable is the last cable to be connected.

Congratulations on your purchase of the SmarTrax system! This system is designed to provide cutting-edge, hands-free steering of the machine via Global Positioning System (GPS) coordinates.

This manual applies to the following machines:

MAKE: CLAAS

MODEL: Lexion 700 Series (Steering Ready) - 730, 740, 750, 760, 770, and 780

FIGURE 1. CLAAS Lexion 760



Preparing for Installation

Before installing the SmarTrax system, park the machine where the ground is level, clean, and dry. Turn off the machine and leave it turned off for the duration of the installation process.

During the installation process, follow good safety practices. Be sure to carefully read the instructions in this manual as you complete the installation process.

Recommendations

Raven Industries recommends the following best practices when installing or operating the SmarTrax system for the first time, at the start of the season, or when moving the SmarTrax system to another machine:

- Install the GPS antenna in the recommended location. Refer to the following table for the machine-specific antenna mounting location.

Machine Preset	Antenna X Position (left to right)	Antenna Y Position (fore/aft offset)	Antenna Z Position (ground to bottom of antenna)
Lexion 700 Series Combines	Centered	17 ft. /5.181 m	13 ft. 1 in./4.013 m

- Ensure the machine's hydraulic filters have been recently changed and there are no issues with the machine's hydraulic system (e.g., pump issues, faulty hydraulic motors, fine metal deposits in the hydraulic hoses, etc.).
- Ensure the machine's hydraulic system is using fresh oil and debris is flushed from the hydraulic hoses, valves, and filters.

Raven Industries recommends the following best practices when installing the SmarTrax system:

- Use part numbers to identify the parts.
- Do not remove the plastic wrap from a part until it is necessary for installation.
- Do not remove plastic caps from a part until it is necessary for installation.

Point of Reference

The instructions in this manual assume that you are standing behind the machine, looking toward the cab.

Updates

Software and manual updates are available on the Raven Applied Technology website:

<http://www.ravenhelp.com>

At Raven Industries, we strive to make your experience with our products as rewarding as possible. One way to improve this experience is to provide us with feedback on this manual.

Your feedback will help shape the future of our product documentation and the overall service we provide. We appreciate the opportunity to see ourselves as our customers see us and are eager to gather ideas on how we have been helping or how we can do better.

To serve you best, please send an email with the following information to

techwriting@ravenind.com

- CLAAS Lexion 700 Series - Steering Ready Combine SmarTrax™ Installation Manual
- P/N 016-5030-047 Rev. B
- Any comments or feedback (include chapter or page numbers if applicable).
- Let us know how long have you been using this or other Raven products.

We will not share your email or any information you provide with anyone else. Your feedback is valued and extremely important to us.

Thank you for your time.

2

Kit Contents

This section contains a list of the components that are included in the SmarTrax kit. Before beginning the SmarTrax installation, compare the items in the kit with the components on this list. If you have questions about the kit, contact your Raven dealer.

TABLE 1. SmarTrax Installation Kit (P/N 117-5030-047)



Picture	Item Description	Part Number	Qty.
Not Pictured	Manual - SmarTrax and SmartSteer Calibration & Operation	016-0171-277	1
Not Pictured	Manual - CLAAS Lexion 700 Series Combines SmarTrax Installation	016-5030-047	1
	Node - SmarTrax RTK	063-0173-228	1
	Bracket - WAS Mounting	107-0172-030	1

TABLE 1. SmarTrax Installation Kit (P/N 117-5030-047)







Picture	Item Description	Part Number	Qty.
	Bracket - Node Mounting	107-0172-055	1
	Bracket - Wheel Angle Sensor Mounting	107-0172-300	1
	Bracket - 4'-5" Muffler Clamp Wheel Angle Sensor Mounting	107-0172-431	1
	Cable - AutoPilot-Ready Node	115-4001-235	1
	Cable - AutoPilot-Ready Valve	115-4001-236	1
	Assembly - Foot Switch	063-0172-470	1
	Assembly - Road Switch	063-0173-505	1
	Assembly - 250 mm 3-Pin Linear Wheel Angle	063-0181-021	1
	Mount - M10 Ball Linear Sensor	103-0001-029	2
	Clamp - 1-1/2" U-Bolt Muffler	435-3003-030	1
	Clamp - 2" Muffler	435-3003-059	1

TABLE 1. SmarTrax Installation Kit (P/N 117-5030-047)

Picture	Item Description	Part Number	Qty.
	Clamp - 3" Muffler	435-3003-063	1
	Clamp - 4-1/2" Muffler	435-3003-070	1
	Bolt - M10 x 1.5 x 60 mm Hex	311-0070-025	2
	Spacer - 0.406" ID x 0.750" OD x 1" Long	107-0172-038	2
	Nut - M10 x 1.5 Pitch Jam	312-1002-035	2
	Nut - 5/16"-18 Nylon Insert Lock	312-4000-059	4
	Nut - M10 x 1.5 Pitch Nylon Insert Lock	312-4000-208	2
	Nut - 3/8"-16 Thin Lock	312-4001-109	5
	Washer - 0.344" ID x 0.688" OD x 0.065" Thick	313-2300-012	2
	Washer - 0.408" ID x 0.812" OD x 0.065" Thick	313-2300-014	2
	Tape - 3.5" Double-Sided	332-0000-019	6

CHAPTER

3

*Wheel Angle Sensor
Installation*

Assemble the Wheel Angle Sensor (WAS)

Single Steering Cylinder Models

FIGURE 1. WAS Assembly



1. Install one M10 jam nut (P/N 312-1001-035) and M10 ball linear sensor mount (P/N 103-0001-029) on each end of the of the 250 mm non-contact WAS (P/N 063-0181-021).
2. Tighten the nuts to ensure the ball mounts are securely installed.

Dual Steering Cylinder Models

FIGURE 2. WAS Assembly



1. Install one M10 jam nut (P/N 312-1001-035) and M10 ball linear sensor mount (P/N 103-0001-029) on the rod-end (the end without the cable connection) of the 250 mm non-contact wheel angle sensor (WAS) (P/N 063-0181-021).
2. Tighten the nut to ensure the ball mount is securely installed.

Mount the WAS

Single Steering Cylinder Models

Important: When installed, verify that the WAS cannot be overextended or compressed when the wheels are turned to their extremes, adjusting the wheel stops as necessary.

FIGURE 3. Wheel Stops



Important: Verify that the sensor moves freely and is not being damaged within its range of motion. The position of the U-bolt muffler clamps installed around the body of the cylinder may have to be adjusted to prevent damage to the WAS.

1. Locate the WAS mounting location on the machine's steering cylinder.

FIGURE 4. Muffler Clamp Installed on Steering Cylinder Barrel



2. Remove the nuts and clamp from the 4-1/2" muffler clamp (P/N 435-3003-070) and install the U-bolt around the right end of the steering cylinder barrel with the U-bolt ends pointing up and angled toward the rear of the machine.

3. Install the clamp on the ends of the U-bolt and secure it using the clamp's two nuts.

FIGURE 5. Base-End of WAS Installed



4. Insert the M10 x 1.5 pitch x 60 mm bolt (P/N 311-0070-025) through the center hole in the large WAS rod mounting bracket (P/N 107-0172-431).
5. Install a 0.406" ID x 0.75" OD x 1" spacer (P/N 107-0172-038) on the end of the installed M10 bolt.
6. Install the WAS mounting bracket on the legs of the installed muffler clamp using 3/8" flat washers (P/N 313-2300-014) and 3/8"-16 lock nuts (P/N 312-4001-109).

Note: The bracket should be positioned so that the M10 bolt points away from the clamp.

7. Install the base-end (end with the cable connection) of the WAS on the M10 bolt and spacer, securing it with one M10 lock nut (P/N 312-4000-208).

FIGURE 6. Rod-End of WAS Installed



8. Position the WAS parallel to the tie rod and extend the rod of the WAS to until it is 1" from full compression or 1" from full extension, depending on whether the rear wheels are turned fully to the left or to the right.
9. Install a muffler clamp (P/N 435-3003-030 or 435-3003-059 as appropriate based on the size of the tie rod) on the tie rod in the location of the M10 ball mount on the rod-end of the WAS.

Note: Position the muffler clamp with the U-bolt ends pointing up and angled toward the rear of the machine.

10. Insert the M10 x 1.5 pitch x 60 mm bolt (P/N 311-0070-025) through the center hole in the small WAS rod mounting bracket (P/N 107-0172-030).
11. Install a 0.406" ID x 0.75" OD x 1" spacer (P/N 107-0172-038) on the end of the installed M10 bolt.
12. Install the WAS mounting bracket on the legs of the installed muffler clamp using 5/16" flat washers (P/N 313-2300-012) and 5/16"-18 lock nuts (P/N 312-4000-059).

Note: *The bracket should be positioned so that the M10 bolt points away from the clamp.*

13. Install the rod-end of the of the WAS on the M10 bolt and spacer, securing it with one M10 lock nut (P/N 312-4000-208).
14. Tighten all nuts used to install the WAS.
15. Route the cable from the base-end of the WAS toward the left side of the machine's frame, routing it so that the cable is not near moving parts or heat sources. Secure with plastic cable ties as necessary.

Dual Steering Cylinder Models

Important: *When installed, verify that the WAS cannot be overextended or compressed when the wheels are turned to their extremes. Also verify that the sensor moves freely and is not being damaged within its range of motion. The position of the U-bolt muffler clamps installed around the body of the cylinder may have to be adjusted to prevent damage to the WAS. Adjust the machine's wheel stops as necessary.*

Note: *The WAS can be installed on either the left or right hydraulic cylinder. The WAS is installed on the left cylinder in the steps below.*

1. Turn the machine's rear wheels fully to the right to access the left side of the rear axle.

FIGURE 7. Rod-End WAS Mounting Hardware Assembled



2. Insert the M10 x 1.5 pitch x 60 mm bolt (P/N 311-0070-025) through the center hole in the WAS rod mounting bracket (P/N 107-0172-030).
3. Install a 0.406" ID x 0.75" OD x 1" spacer (P/N 107-0172-038) on the end of the installed M10 bolt.
4. Insert the end of the M10 bolt through the hole in the M10 linear ball sensor mount (P/N 103-0001-029) installed on the rod-end of the WAS.
5. Secure the WAS mounting bracket to the WAS using one M10 x 1.5 nylon insert lock nut (P/N 312-4000-208).

FIGURE 8. Small Muffler Clamp Installed



6. Remove the nuts and clamp from the 1-1/2" muffler clamp (P/N 435-3003-030) and install the U-bolt around the end of the steering cylinder shaft with the U-bolt ends pointing up.
7. Install the clamp on the ends of the U-bolt and secure it using the clamp's two nuts.

FIGURE 9. Rod-End of WAS Installed



8. Insert the legs of the installed U-bolt muffler clamp through the holes in the rod-end WAS mounting assembly and secure the bracket using two 5/16"-18 nylon insert lock nuts (P/N 312-4000-059).

FIGURE 10. Large Muffler Clamp Installed



9. Remove the nuts and clamp from the 3" muffler clamp (P/N 435-3003-063) and install the U-bolt around the base-end of the steering cylinder shaft with the U-bolt ends pointing up.
10. Install the clamp on the ends of the U-bolt and secure it using the clamp's two nuts.

FIGURE 11. WAS Installed on Base-End of the Steering Cylinder



11. Insert the legs of the installed U-bolt muffler clamp through the holes in the base-end WAS mounting bracket (P/N 107-0172-300) so that the flange of the bracket is toward the end of the steering cylinder and secure the bracket using 0.344" x 0.688" OD x 0.065" flat washers (P/N 313-2300-012) and two 5/16"-18 nylon insert lock nuts (P/N 312-4000-059).
12. Insert the stud on the base-end of the WAS (the end with the cable connection) through the hole in the base-end WAS mounting bracket and secure it using one M10 x 1.5 lock nut (P/N 312-4000-208).
13. Tighten all nuts used to install the WAS.
14. Route the cable from the base-end of the WAS along the left side of the machine's frame, routing it so that the cable is not near moving parts or heat sources. Secure with plastic cable ties as necessary.

CHAPTER

4

*Cab Component
Installation*

Install the SmarTrax Node

Mount the SmarTrax Node

FIGURE 1. SmarTrax Node Installed



Note: *The forward vehicle direction is 2 in the pictured node orientation.*

1. Identify the node mounting location of the floor in the front-right corner of the cab in front of the fuse panel compartment.
2. Clean the floor mat.
3. Install the SmarTrax node (P/N 063-0173-228) on the node mounting bracket (P/N 107-0172-055) using three 3/8"-16 lock nuts (P/N 312-4001-109).
4. Apply 5 strips of double-sided tape (P/N 332-0000-019) to the back of the node mounting bracket.
5. Adhere the node mounting bracket to the floor mat, positioning it so that the node connectors are on the right side of the cab.

Node Mounting Locations

FIGURE 2. Node Mounting

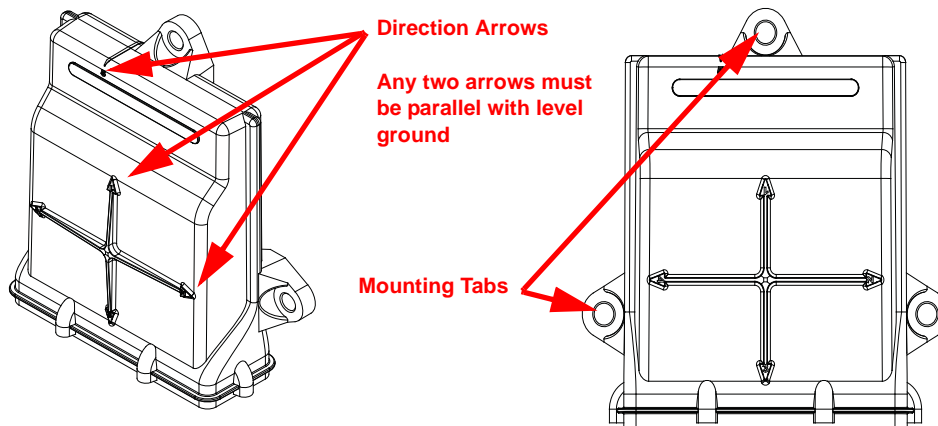

When choosing the location for the SmarTrax node, consider the following points:

- Mount the SmarTrax node inside the machine's cab on a flat, level surface for proper performance and cable connection.
- One of the six numbered direction arrows on the node must be oriented in the direction of forward vehicle travel, one arrow pointing straight up, and two of the arrows parallel to the ground.

Note: Make a note of the number of the arrow that is oriented in the direction of forward vehicle travel. This number will be needed during the SmarTrax calibration process.

- The node mounting location must not create tripping hazards.
- Mount the node in a location where it will not be kicked or jarred during normal equipment operation.
- The location must allow cable routing to avoid crimping or damaging the cables or the node connections.
- Securely fasten the node using bolts or screws through at least two of the three mounting holes. When mounted properly, the node should not become loose or rotate.

Install the Foot Switch

FIGURE 3. Foot Switch Installed



1. Select a suitable location for the foot switch (P/N 063-0172-470) to be installed.

Note: *The foot switch should be installed in a location where the operator has easy access to it and is able to fully press the pedal.*

2. Using the holes in the foot switch as a template, drill holes in the floor of the cab.
3. Secure the foot switch to the floor by installing the supplied screws in each of the mounting holes.
4. Route the foot switch cable to the node mounting location.

Install the Road Switch

FIGURE 4. Road Switch Assembly



1. Select a suitable location for the road switch assembly (P/N 063-0173-505) to be installed.

Note: *The road switch should be mounted in a location within the operator's reach.*

2. Apply one strip of double-sided tape (P/N 332-0000-019) to the switch housing.
3. Remove the backing from the double-sided tape.
4. Install the road switch assembly to the chosen mounting location.

Install the Node Harness

FIGURE 5. Node Harness Installed on SmarTrax Node



1. Install the two large, rectangular connectors of the node harness (P/N 115-4001-235) into the correct ports of the node, tightening the bolts on the connectors to secure the connections.
2. Locate the ENABLE connector on the node harness and connect it to the foot switch (P/N 063-0172-470) cable connector.
3. Locate the ROAD SWITCH connector and connect it to the installed road switch (P/N 063-0173-505).
4. Route the STEERING WHEEL connectors to the steering column in the front of the cab.

FIGURE 6. Steering Wheel Sensor and Connections



5. Disassemble the steering column to access the steering wheel sensor.
6. Disconnect the machine's steering wheel sensor connection.
7. Connect the STEERING WHEEL connection from the node harness to the steering wheel sensor connection.
8. Route the cable out the front of the steering column.
9. Reassemble the steering column.

Install the Valve Harness

1. Start with the valve harness (P/N 115-4001-236) outside the cab on the left side.

FIGURE 7. Access Area for Routing Valve Harness



2. Route the 12-pin connector behind the cab to the right side of the machine.

FIGURE 8. Cab Access Panel



3. Route the 12-pin connector into the cab through the access panel in the back-right corner of the cab.

Note: *It may be necessary to cut a hole in the access panel to achieve cable routing.*

4. Open the fuse panel cover inside the cab.
5. Route the 12-pin connector forward and connect it to the mating connector on the node harness (P/N 115-4001-235).

FIGURE 9. Left Side Access Panel



6. Open the left side access panel on the machine.

FIGURE 10. Steering Hydraulic Line Tee Fittings

Single Steering Cylinder Models



Dual Steering Cylinder Models

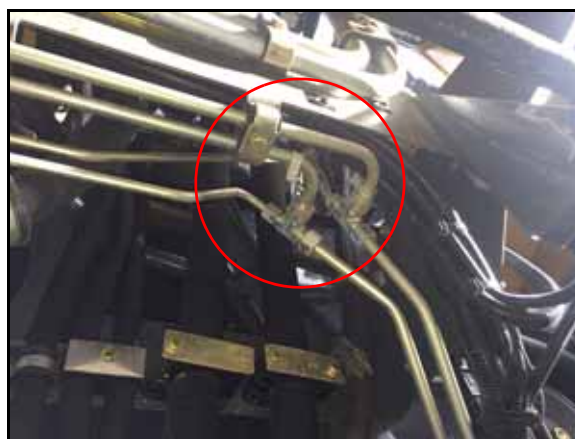

7. Locate the hydraulic steering cylinder lines at the rear axle.
8. Trace the steering lines forward to the point of entrance into the machine's hydraulic valve.

Note: *There will be hydraulic tee fittings between the valve and the axle.*

FIGURE 11. Machine's Hydraulic Valve

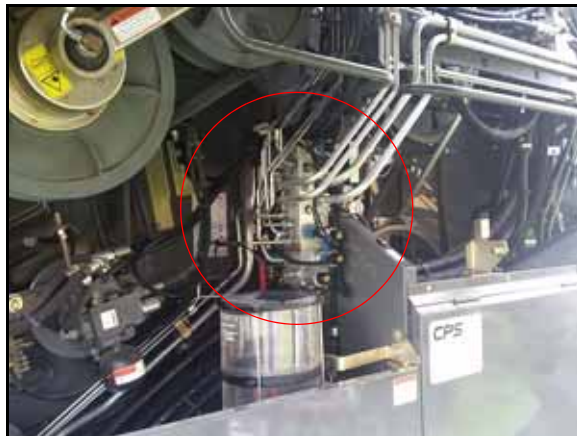

9. Disconnect the cable connectors from the steering solenoids on the machine's hydraulic valve.

Note: The machine's steering line solenoid connectors are not used in the SmarTrax system.

FIGURE 12. Machine's Solenoid Connections

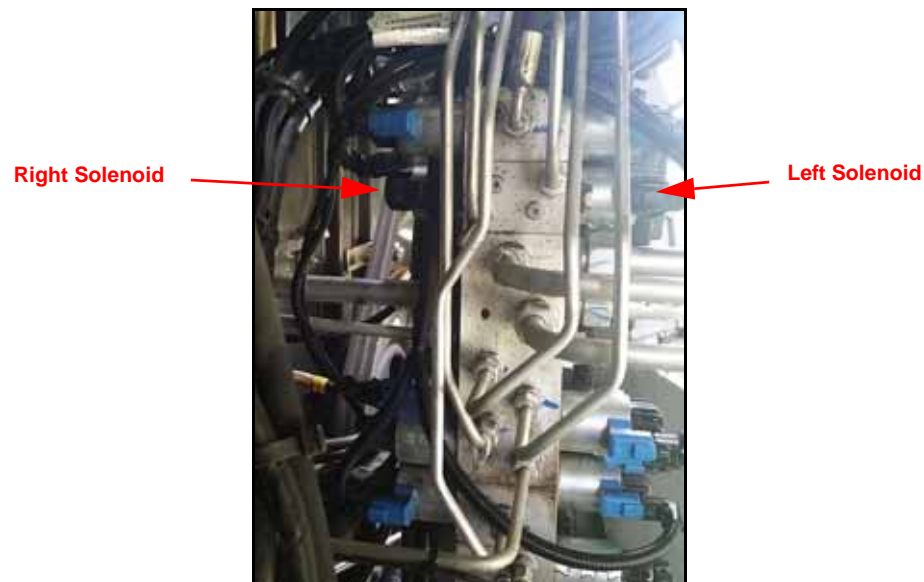

10. Route the LEFT and RIGHT cable connectors of the valve harness toward the machine's hydraulic valve.

Important: Carefully route the cable along existing cable and hose paths, avoiding moving parts and heat sources. Secure the cable connectors with plastic cable ties.

11. Remove the dust caps from the LEFT and RIGHT cable connectors of the valve harness and install them on the machine's cable connections that were disconnected in step 9.

FIGURE 13. LEFT Valve Harness Connector Installed



12. Connect the LEFT valve harness connector to the machine's left steering solenoid connector.

FIGURE 14. RIGHT Valve Harness Connector Installed



13. Connect the RIGHT valve harness connector to the machine's right steering solenoid connector.

Note: *The LEFT and RIGHT solenoid connectors are interchangeable. If the connectors are accidentally switched, the SmarTrax system will identify and correct the error during system calibration.*

14. Route and connect the WAS cable connector to the WAS cable connector installed on the rear axle.

Important: *Carefully route the cable along existing cable and hose paths, avoiding moving parts and heat sources. Secure the cable connectors with plastic cable ties.*

FIGURE 15. Valve Harness Diagram

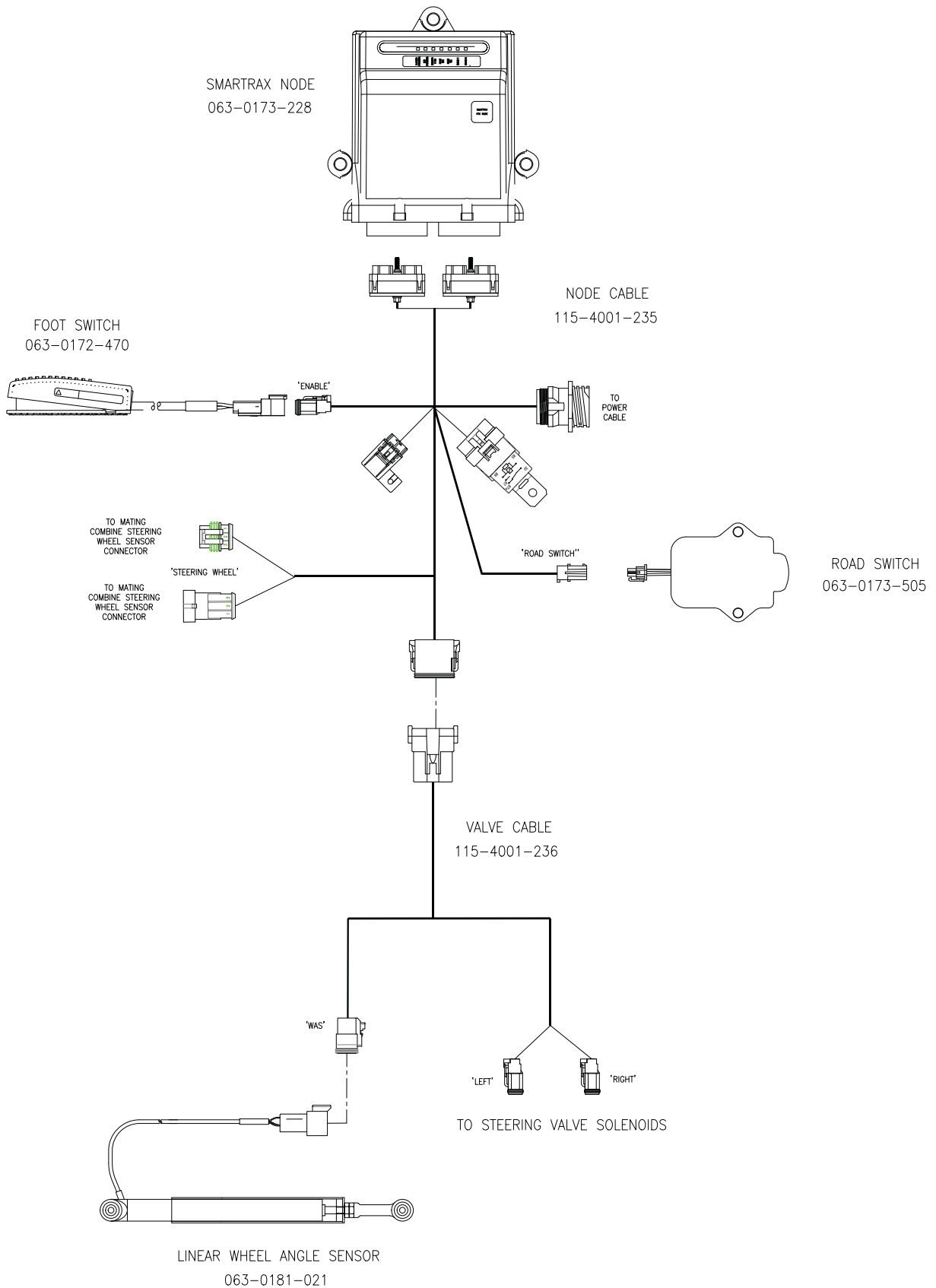

Install the Chassis Cable - SmarTrax-Only Systems (If Applicable)

If the machine does not contain an existing chassis power system (such as SmartYield™ Pro), it is necessary to install the chassis power cable to operate the SmarTrax system. If a CAN system already exists on the machine, refer to *Connect SmarTrax to an Existing SmartYield™ Pro (If Applicable)* below to connect power to the SmarTrax system.

Note: *The chassis cable is sold separately. Contact your local Raven dealer for ordering information.*

1. Locate the SmarTrax chassis cable (P/N 115-4001-085).
2. Connect the TO SMARTRAX NODE connector from the chassis cable to the round 16-pin connector on the node harness (P/N 115-4001-235).
3. Connect the TO CONSOLE CABLE connector to the Raven console cable.
4. Install a terminator (P/N 063-0172-369) on the CAN cable connector.
5. Loop and tie-off the REMOTE SWITCH cable connection, securing it with plastic cable ties as necessary.

Note: *The REMOTE SWITCH connector is not used in the SmarTrax system. Ensure the cable is secured away from moving parts and heat sources.*

6. Connect the ring terminals to the battery.

Note: *The positive connectors are fused.*

Connect SmarTrax to an Existing SmartYield™ Pro (If Applicable)

1. Remove the plug from the round 16-pin connector on the Envizio Pro console harness.
2. Connect the SmarTrax node harness (P/N 115-4001-235) to the 16-pin connector of the Envizio Pro harness.

Calibrate the SmarTrax System

Refer to the SmarTrax and SmartSteer Calibration & Operation Manual (P/N 016-0171-277) for instructions on calibrating the SmarTrax system, adjusting system settings, and system operation.

Important: *When transporting the vehicle, press down on the side of the road switch that contains the icon. To use SmarTrax in the field, toggle the road switch in the opposite direction.*

System Diagrams

CRUIZER II RTK SMARTRAX W/SLINGSHOT

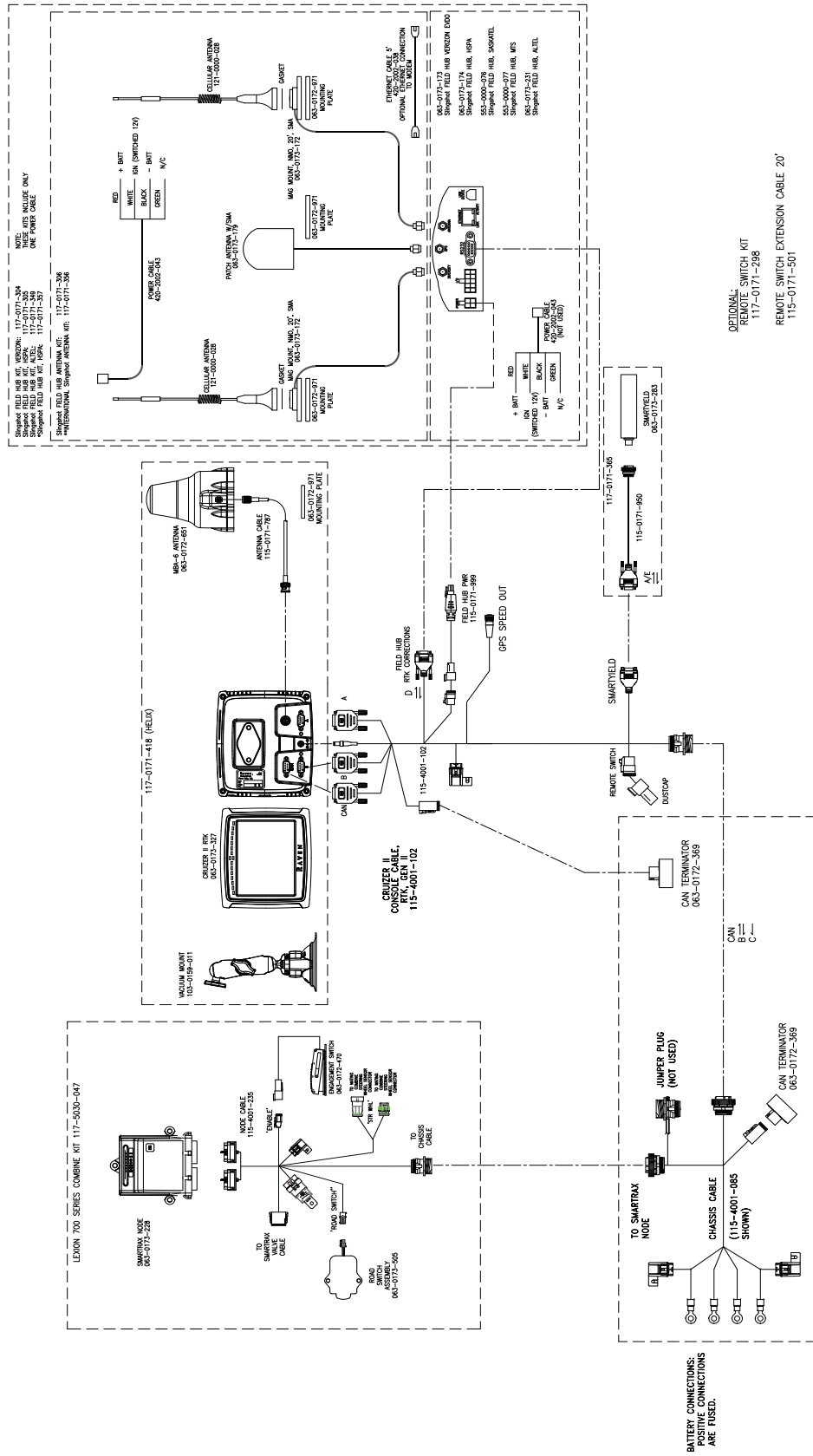

C

Cab Component Installation 15

- Calibrating the SmarTrax System 24
- Connecting SmarTrax to an Existing SmartYield Pro System 24
- Installing the Chassis Cable - SmarTrax-Only Systems 24
- Installing the Foot Switch 16
- Installing the Node Harness 18
- Installing the Road Switch 17
- Installing the SmarTrax Node 15
 - Mounting the SmarTrax Node 15
 - Node Mounting Locations 16
- Installing the Valve Harness 19
- System Diagrams 25

I

Important Safety Information 1

- Electrical Safety 2
- Hydraulic Safety 2

Introduction 3

- Kit Contents 5
- Preparing for Installation 3
 - Point of Reference 4
 - Recommendations 4
- Updates 4

K

Kit Contents 5

M

Mount the WAS

- Dual Steering Cylinder Models 12
- Single Steering Cylinder Models 10

W

Wheel Angle Sensor Installation 9

- Assembling the Wheel Angle Sensor 9
 - Dual Steering Cylinder Models 9
 - Single Steering Cylinder Models 9
- Mounting the Wheel Angle Sensor 10
 - Models with Two Steering Cylinders 10

