

# Operator Manual



*Manual Steer*



## WARNING

### It's the law, you must be trained and certified to operate this truck.

(OSHA § 1910.178, Rev. 1999)

You or others around you can be seriously injured or even killed if you don't use this truck correctly.

Read and obey all warnings and instructions in this Manual\* and on the truck.

Head, arms, hands, legs or feet outside the operator area can be pinned or crushed whenever the truck is moving. Stay within the operator area and **stop the truck completely before getting off.**

A dockboard can move or drop while you are on it. Or you could drive off a dock. Falls from docks or dockboards can cause serious injury or even death. **Make sure you are safe.**

Inspect your truck before starting work, make sure it is in good working order.

\* Additional copies of this Operator Manual and all Truck Labels can be obtained from Crown Equipment Corporation, New Bremen, Ohio 45869 U.S.A.

All rights reserved under International and Pan American copyright conventions  
Copyright 2008 Crown Equipment Corp.

# You Must be Trained



### IT'S THE LAW, YOU MUST BE TRAINED AND CERTIFIED

Federal law states that only properly trained operators are permitted to operate a powered industrial truck and that your employer must train you and certify that you are qualified to operate this powered industrial truck. (OSHA §1910.178, Rev. 1999)

**Do not operate this truck** in your work place until you have been trained and certified by your employer.



**You could be killed or seriously injured** if you are not adequately trained for lift truck operation!

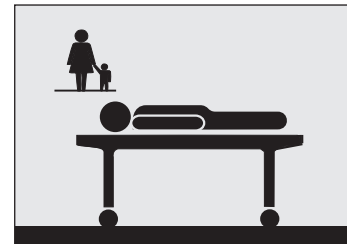

# Protect Yourself

## ! Know the Hazards

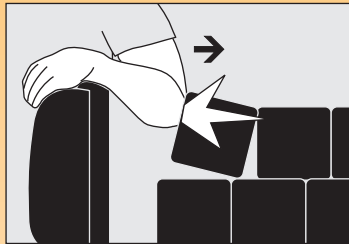
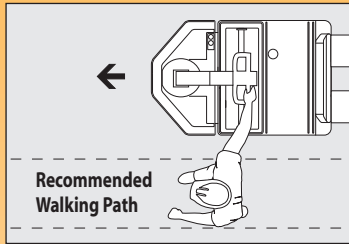

### DRIVE CAREFULLY

- When allowing the truck to coast, travel power unit first only. Do not turn. Keep to the side of the truck. Make certain the truck won't hit the back of your leg or foot. Don't let the truck run over your foot.
- When riding, keep your hands on the controls and feet on the platform. Keep your body within the operator area.
- Don't put hands or arms over the backrest.
- Never stick a foot or any part of your body outside the truck, no matter how slow the truck is moving. You can not stop 4535 kg or 10,000 pounds with any part of your body. A foot or hand caught between the truck and a fixed object will be crushed or even cut off.
- Never place objects anywhere on the operator platform. They would be a trip hazard and could affect truck speed.
- Stay away from the edge of docks and dockboards. Make sure dockboards are secure. Check that trailer wheels are chocked. You could be seriously injured or even killed in a fall from a dock or dockboard.
- Keep your truck under control at all times. Drive at a speed that allows you to stop safely. Be even more careful on slippery or uneven surfaces. Do not drive over objects on the floor.
- Perform all truck movements smoothly and at a speed that will give you time to react in an emergency.

## ! Know the Hazards

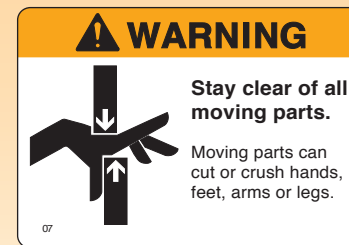
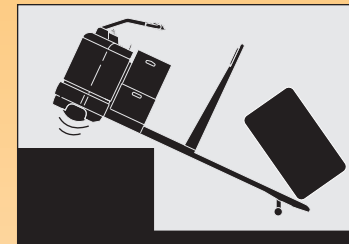

### LOOK WHERE YOU'RE DRIVING

Always be alert to the area around you and watch where you are driving. You could be pinned or crushed by objects intruding or poking into the operator area. When allowing the truck to coast, make certain the area ahead of you is clear.

### AVOID FALLS

Falls are very serious accidents, you can be crushed or even killed. The best way to prevent injury is to know where you are at all times and follow the rules of safe truck operation. Unless you can safely jump completely clear of the falling truck, there is no sure way to avoid injury if you drop from a dock or dockboard.

Be extremely careful when working around docks, dockboards and trailers.

### USE YOUR TRUCK SAFELY

- Keep your hands and feet away from all moving parts such as forks or wheels.
- Never allow passengers on the truck. There is no safe place for them.
- Before you leave your truck:
  - Come to a complete stop.
  - Lower the forks to the floor.
  - Shut the truck off with the key or disconnect the battery.

# Contents

Warning	1
You Must be Trained	2
Protect Yourself	3
Contents	5
What's in it for You?	6
Your Rider Pallet Truck	7
Pallet Truck Parts	9
Capacity Plate	11
Display	13
Power On & Off	15
Steering & Travel	16
Coasting	17
Braking	19
Raising & Lowering	21
Traveling & Plugging	23
Additional Options	25
Daily Safety Check	27
Be a Safe Driver	29
Battery Maintenance	33
Warning Labels	36

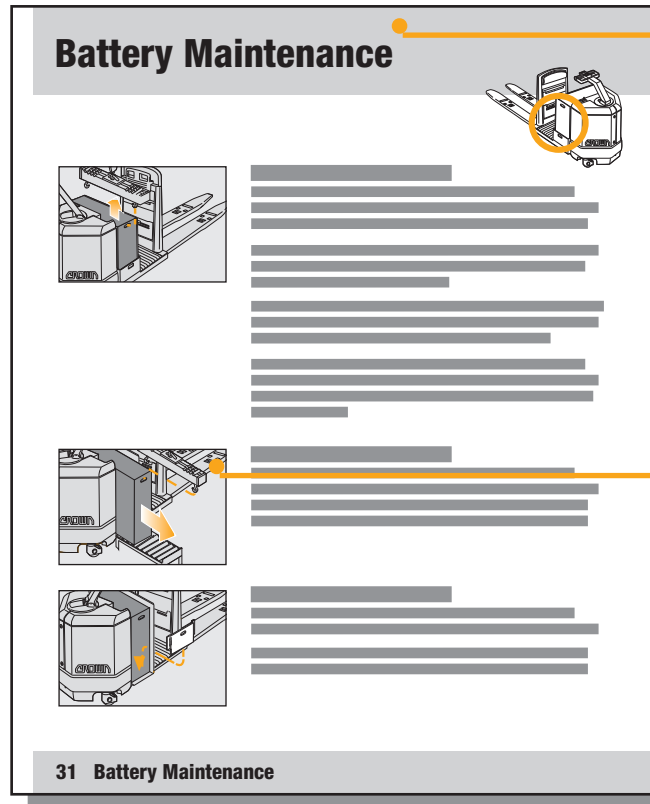

# What's in it for You?

## WHAT'S IN IT FOR YOU?

The better you understand your truck and how to use it, the better and safer operator you can be. Here are some guides to using this manual.

### QUICK LOCATORS

In addition to the "Contents" page you can use page headings to find topics. Some pages also have a picture of the truck in the corner showing features or functions covered on that page.

### "KNOW THE HAZARDS"

Watch for and read these special blocks. You will find information about possible safety hazards and how to avoid them.

### HOW-TO-DRAWINGS

On many pages you will find pictures as well as text to help you understand how to use your truck safely and productively.

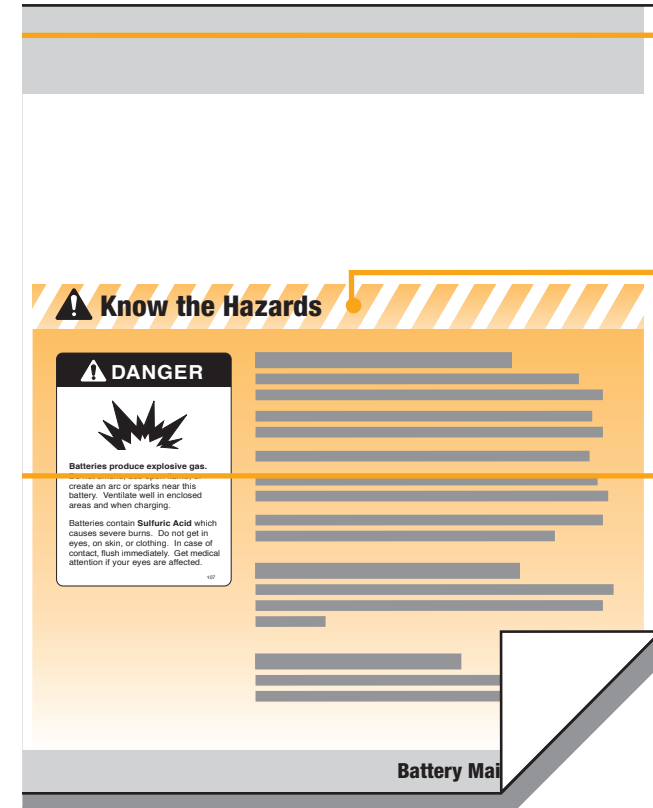

# Your Rider Pallet Truck

## RIDER PALLET TRUCKS

As a rider your pallet truck is designed to move loads over long distances. You can also use it as a walk-beside truck when picking stock.

## YOUR PALLET TRUCK IS NOT AN AUTOMOBILE

With a load it may weigh more than 3 automobiles.

- You don't steer the same.
- You don't brake the same.
- You don't accelerate the same.

## HOW TO DRIVE WHEN COASTING

- Travel power unit first only. Do not turn. Stay to one side of the truck. Use the hand closest to the truck to operate the control handle.
- Watch your feet. Stay out of the path of the truck.
- Make certain the area ahead of you is clear.

## HOW TO DRIVE YOUR TRUCK WHILE RIDING

Keep both feet on the platform. Place both hands on the control handle and lean against the backrest. Keep your entire body within the operator area.

## HOW TO DRIVE YOUR TRUCK FORKS FIRST

Keep both feet on the platform. Place one hand on the backrest and the other on the control handle while leaning against the backrest. Keep your entire body within the operator area.

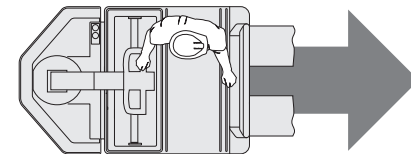
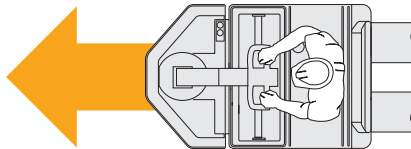
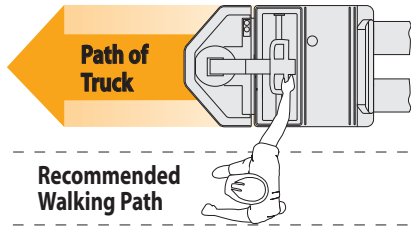
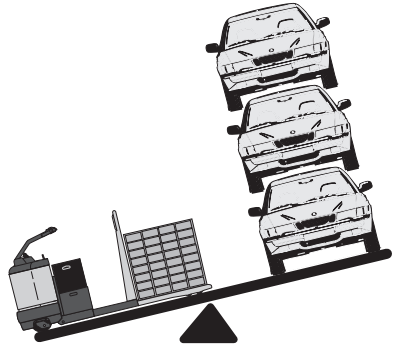

## GIVE YOUR BODY A BREAK

Take advantage of stop time. Flex your arms and legs. Staying alert will help you be a better and safer driver.



## BUILT TO STANDARDS

This truck was designed and built to current industry and government standards and guidelines. For more information see the following:

- American National Standards Institute (ANSI/ITSDF) B56.1
- Occupational Safety and Health Act (OSHA) §1910.178, Rev. 1999
- Underwriters Laboratory (UL 583)
- National Fire Prevention Association (NFPA 505)

# Pallet Truck Parts

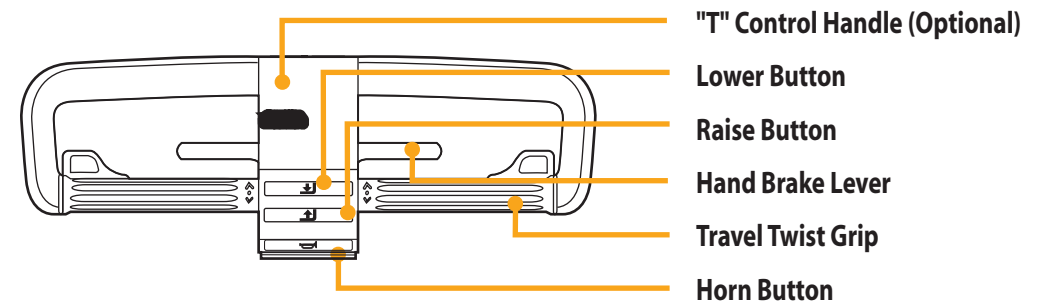
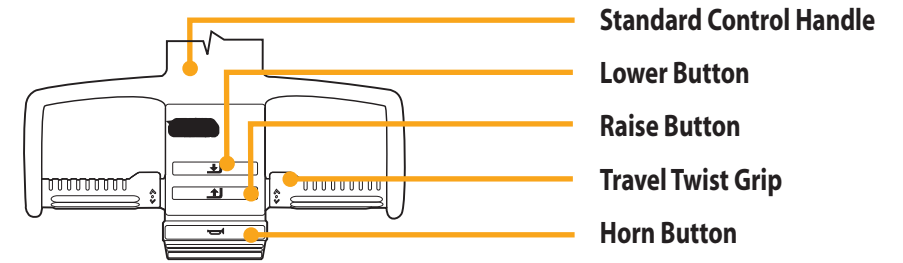
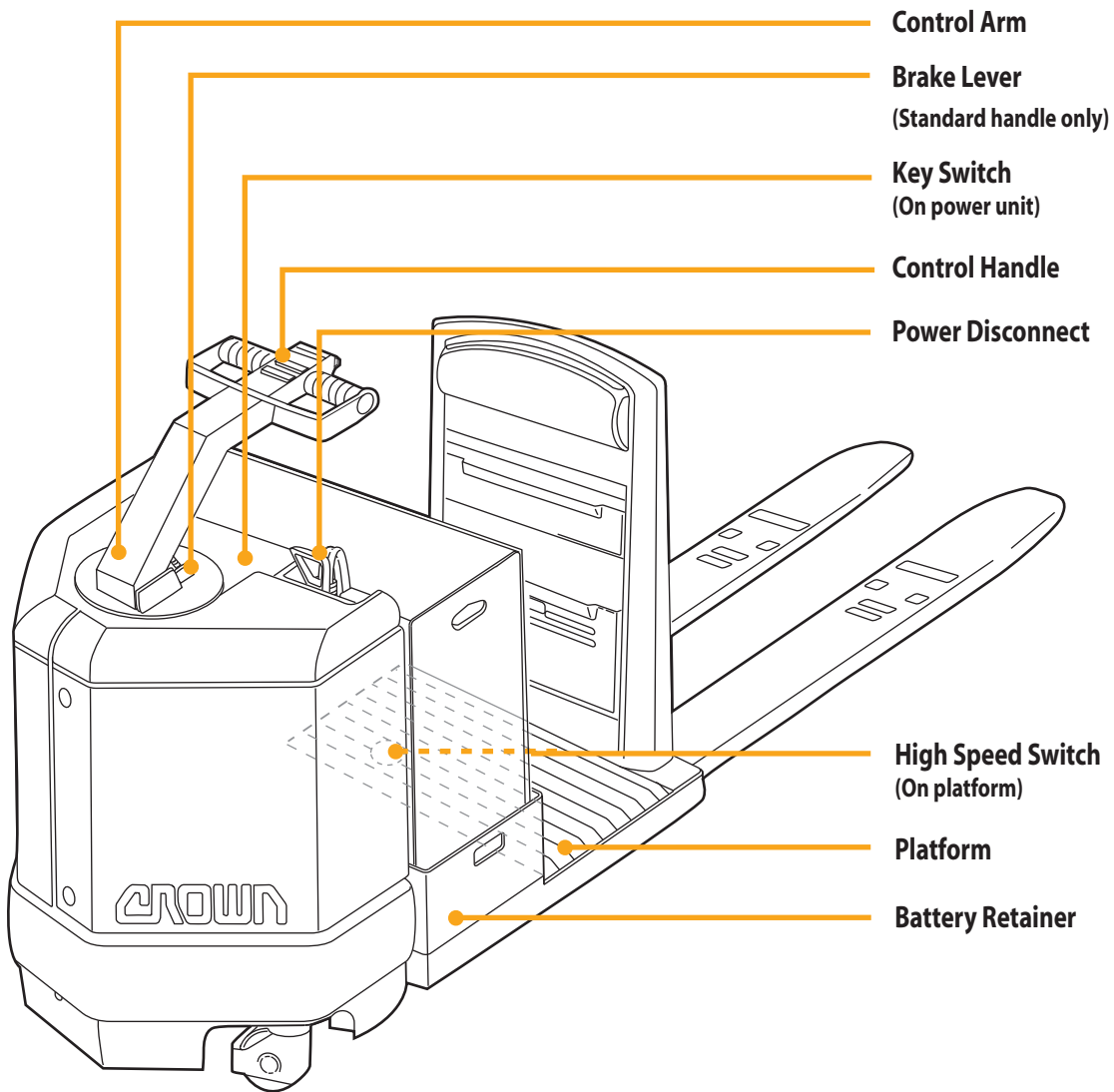



# Capacity Plate

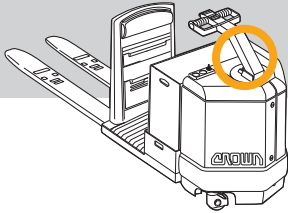

### CAPACITY PLATE INFORMATION

The capacity plate is on the top of the power unit cover. It contains:

- Capacity information
- Truck type (a fire safety rating)
- Truck weight (does not include load)
- Grade rating
- Battery information
- Truck information

### WHAT IS YOUR TRUCK CAPACITY?

Capacity is the maximum load that can be lifted or transported with your truck. See the capacity plate on your truck. Make certain you use the correct units of measure.

**SAMPLE CAPACITY PLATE**  
The information shown on this sample plate does not apply to your truck.

	Units of measure: kg/mm (lb/in)	Truck Data Number	Max. Grade
	Capacity with Equally Distributed Load	1234567890123456	5 %
	2720 (6000)	Total Battery Weight	Hour Rate
	1676 (3690)	Min 440 (975) Max 680 (1500)	6
	Truck Weight as Equipped with Max. Battery	Model Number	D.C. Voltage
	991 (2190)	PC4500XX	24
	Approx. Truck Weight as Equipped, Less Battery	Battery Type	Load Tire Tread Width
	991 (2190)	E	24
	Serial Number		Max. AMP Hr.
	A123456756		600
	Truck Type	This truck as released conforms to the mandatory requirements of ANSI B56.1 Crown Equipment Corporation New Bremen, Ohio 45869 USA	
	E		

**Note:** ANSI B56.1 requires that all data be shown first in Metric units and then USA units.

## ! Know the Hazards

### KNOW YOUR LOAD

Do not exceed the capacity shown on your truck's capacity plate. Make certain you use the correct units of measure. Be careful when handling long, high or wide loads. Do not handle unstable loads.

### TRUCK TYPE

Some truck types are not permitted in areas where there are fire hazards. Watch for marked areas. *For example: You must not drive a type E or ES truck into an area restricted to EE or EX trucks.*

### TRUCK WEIGHT

Dockboards, elevators and some floors have limited capacity. Check your capacity plate for the weight of your truck. Remember to add the weight of the battery and the load you have on the forks.

# Display

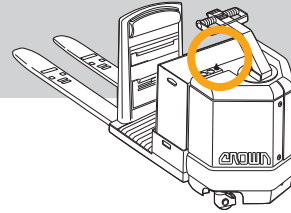

## **BATTERY CHARGE DISPLAY**

The green bars show how much charge is left. Have the battery changed or recharged if the yellow light is flashing.

## **MESSAGE PANEL**

Displays truck information such as: hours of operation, event codes along with instructions, battery charge and other data.

## **PERFORMANCE SETTING**

Indicates the level that your company has programmed this truck to operate at.

## **ENTER OR RETURN BUTTON**

Use to navigate in and out of menus and select inputs.

## **NAVIGATION BUTTONS**

Up, Down, Left and Right Arrows are used to scroll through menus.

## **EVENT CODE LIGHT (OPERATOR CORRECTABLE)**

The display light shows a detected event which the operator can correct. See the display for instructions.

## **EVENT CODE LIGHT (SERVICE REQUIRED)**

The display shows the code for a detected event which requires service. Contact your supervisor or service department.

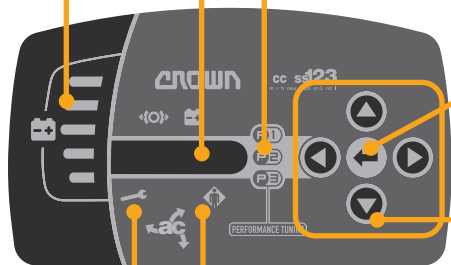

This page  
left blank  
intentionally.



# Power On & Off

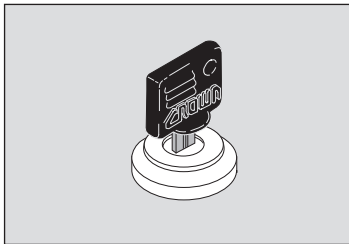
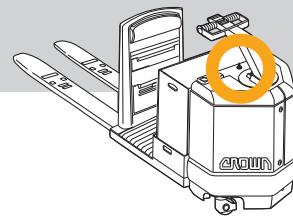

## KEY SWITCH

Turn the truck on by turning the key clockwise to ON. Check that all display lights are working.

Turn the truck off by turning the key counterclockwise to OFF.

Always turn the key off when leaving the truck.

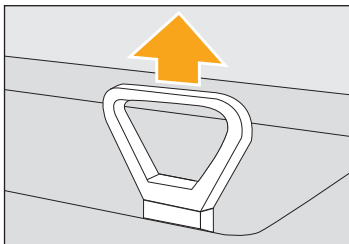

## POWER DISCONNECT

Pull up on the battery connector, or the optional handle, to disconnect the battery and cut all power.

Always disconnect the battery any time the truck isn't working right. The key switch does not cut all power to the truck.

Don't use the truck if it's not working right. Report the problem to your supervisor.

# Steering & Travel

## STEERING

You control steering by moving the control handle from side to side. *For example: This picture shows the directions the truck can turn when the control handle is moved to the approximate position shown.*

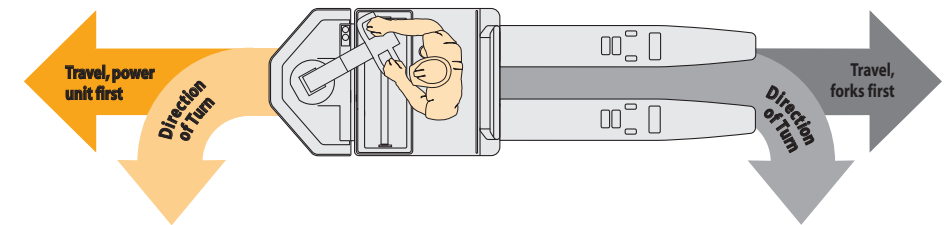

## Know the Hazards

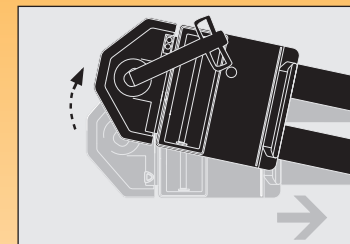

### POWER UNIT SWING

Be careful turning while traveling forks first. The power unit will swing wide in the opposite direction. Make sure you have clearance, and watch out for people in the area.

Keep your hands and feet in the operator area.

**Warning:** Never place objects anywhere on the operator platform. They would be a trip hazard and could affect truck speed.



### SLOW DOWN FOR SPILLS OR WET FLOORS

Powder or liquid spills can cause slippery floors. Slow down or you could lose control of steering and braking. Be careful and allow for a longer stopping distance.

Don't run over objects on the floor.

# Coasting



## COASTING

Coasting can make it easier for you to pick loads while walking to the side of the truck.

The ability to coast is standard on all handles. The coasting distance can be adjusted by your service personnel.

## TO COAST

If the brake lever is placed in the OFF position when you release the control handle and/or the twist grip, the brake is partially applied to allow the truck to coast to a controlled stop.

However you can apply the brake by moving the control handle up to the BRAKE ON position.

Be even more careful when coasting. Make sure you understand the possible hazards. Don't place yourself or others at risk. When moving from the riding position to the walk beside or coast position, stop your truck completely before getting off.

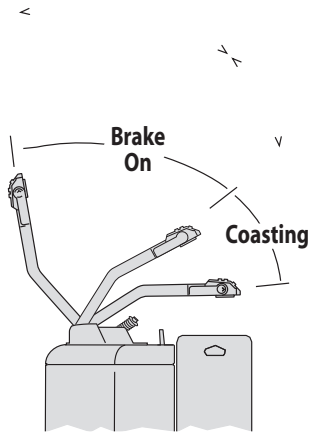

### BRAKE LEVER ON, Standard Control Handle

Move the brake lever toward the control handle.

When you let go of the control handle it will automatically go to the BRAKE ON position.

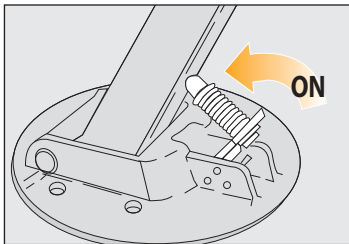

### BRAKE LEVER OFF, Standard Control Handle

Move the brake lever away from the control handle.

When you let go of the control handle the truck will coast. To apply the brake you must move the control handle up to the BRAKE ON position.

Stop your truck completely before getting off.

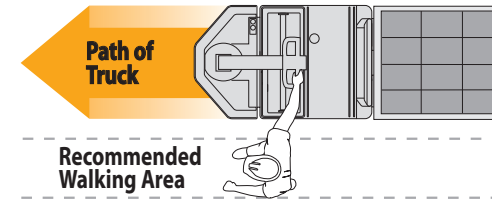
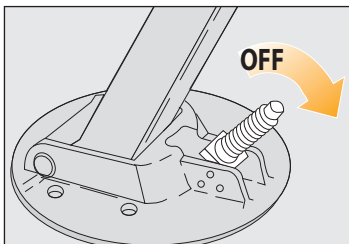

## WHEN COASTING

- Travel power unit first only. Do not turn.
- Don't get in the path of the truck. Watch your feet.
- Stay to the side of the truck. Keep your arm extended to give maximum clearance between you and the truck.
- Make sure the area ahead of you is clear.

## ! Know the Hazards



### COASTING REQUIRES EVEN MORE CAUTION

- Floors must be level and free of obstacles.
- Never allow the truck to coast into a cross aisle.
- Do not coast in pedestrian walkways.
- Watch out for people and other trucks.
- Do not walk in the path of a coasting truck. Stay to the side of the truck with your arm extended and keep your feet clear.
- When coasting, travel power unit first only. Do not turn.
- Always move the brake lever to the on position when you finish a coast operation.
- Always stop your truck completely before getting off.

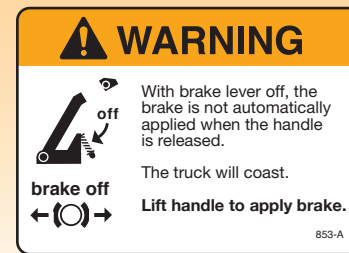

# Braking

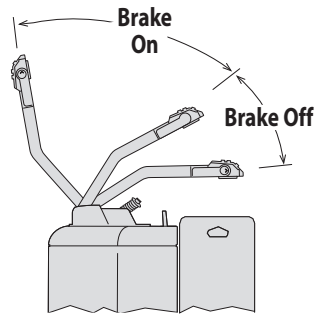
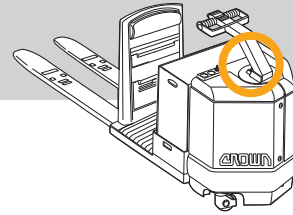

## **BRAKING WITH THE STANDARD CONTROL HANDLE**

To apply the brake, move the control handle up to the BRAKE ON position.

If the brake lever (see page 17) is ON, the control handle will automatically go to the BRAKE ON position when you let go of it.

If the brake lever is OFF when you let go of the control handle, the handle will stay in the BRAKE OFF position and the truck will coast unless you move the control handle up to the BRAKE ON position.

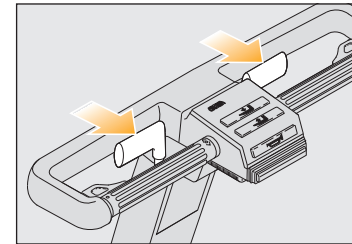

## **BRAKING WITH THE "T" CONTROL HANDLE OPTION**

### **Hand Brake**

Pull the brake levers toward the twist grips to apply the brake.

Always check the braking distance before you start driving.

### **PARKING BRAKE**

The parking brake is automatically applied when the key switch is turned off, the battery is disconnected or after the truck comes to a stop.

This applies to the standard handle and all optional handles.

## **! Know the Hazards**



### **MAKE SURE YOUR BRAKE WORKS**

Test the brake on your truck at the start of each shift. Know the distance it takes to stop before you start working.

If at any time the stopping distance is too long for you to stop safely, don't drive the truck. Report any problem to your supervisor.

### **SIMILAR LOOKING TRUCKS CAN BE DIFFERENT**

Your company has selected the options which are best for your work area.

If you ever drive a different truck, even one that looks just like yours, be careful. It may not have the same controls, functions, or options.

# Raising & Lowering

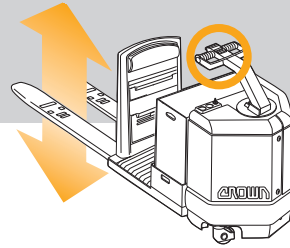

## RAISE

Push the RAISE button until the forks are at the desired height.

## PRESET LIFT HEIGHT

This feature, when used, allows your company to select the most efficient lift height for your use. Press and hold the RAISE button until the forks stop. To raise beyond that height, release and then press and hold the RAISE button again.



## LOWER

Push the LOWER button until the forks are at the desired height.

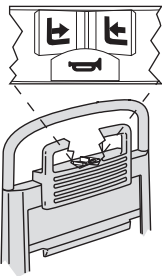

## ADDITIONAL RAISE & LOWER BUTTONS, OPTION

You can also control raise & lower from the optional Backrest Control Module.

Don't place your hands or arms over the backrest. They could be pinned or crushed by the load.

This page  
left blank  
intentionally.

## Know the Hazards

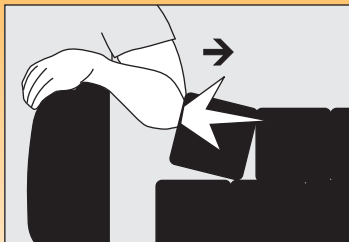

### WATCH YOUR HANDS AND ARMS

Your arm could be pinned or crushed between the backrest and a load.

Loads can shift and fall against the backrest.

Keep your hands and arms on the power unit side of the backrest.

# Traveling & Plugging

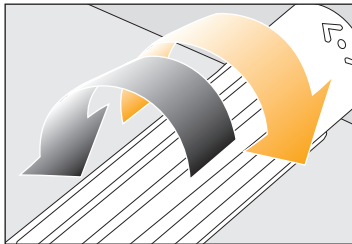
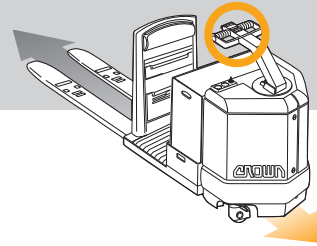

## TRAVEL

Rotate the top of the twist grip in the direction you want to travel.

The farther you rotate the grip from the neutral position, the faster the truck will travel.

## PLUGGING

Plugging is another way to slow down your truck. While the truck is moving, in either direction, move the twist grip through neutral to the opposite direction of travel.

Plugging will not hurt your truck.

## ONE TOUCH HIGH TRAVEL SPEED, OPTION

For high travel speed while riding the truck, rotate the twist grip, then step down on the high travel speed pedal. If you remove your foot from the pedal, the truck will continue to travel in high speed.

When the twist grip is returned to neutral, the speed control will reset to standard operation.

## HIGH TRAVEL SPEED WITHOUT ONE TOUCH

Rotate the twist grip, then step down on the high travel speed pedal.

When you remove your foot from the pedal, or the twist grip is returned to neutral, the speed control will reset to standard operation.

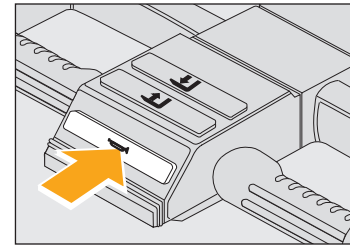

## HORN

Press the horn button on the control handle to sound the horn. Use it to warn pedestrians and other drivers.

Use your horn when you leave an aisle, or come to a crosswalk or intersection.

## ! Know the Hazards

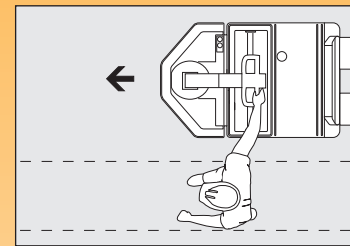

## WATCH YOUR FEET AND HANDS

- While riding, keep your feet on the platform and hands on the controls at all times. A loaded truck can weigh over 4535kg (10,000 lbs). You can not stop or even slow it down with your foot, hand or any part of your body, no matter how slow the truck is moving.
- When coasting, protect your legs and feet by staying to the side. Keep out of the path of the truck. Travel power unit first only. Do not turn.



## LOOK WHERE YOU'RE DRIVING

- Always be alert to the area around you and watch where you are driving.
- A hand or foot caught between the truck and a wall, post or any fixed object will be crushed or even cut off.
- You could also be seriously injured by objects intruding or poking into the operator area.

## PLUGGING VS. BRAKING

Of the two, the foot brake is designed to stop the truck in the shortest distance. Use the foot brake in an emergency, on ramps or in busy areas.

# Additional Options

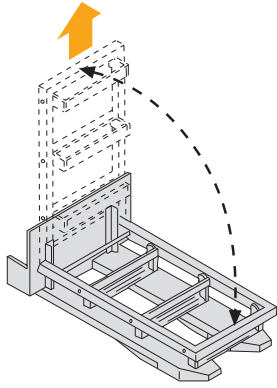

## SKID ADAPTOR OPTION

Lift the skid adaptor until you can move it forward and lower it to the forks.

Make certain the skid adaptor is secure when you return it to the upright position.

This page  
left blank  
intentionally.

## Know the Hazards

### SIMILAR LOOKING TRUCKS CAN BE DIFFERENT

Your company has selected the options which are best for your work area.

If you ever drive a different truck, even one that looks just like yours, be careful. It may not have the same control handle, functions or other options.



# Daily Safety Check

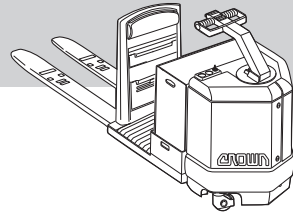

## CHECK YOUR TRUCK BEFORE STARTING WORK

You must make sure your truck is safe to use.

### 1. Walk around your truck and check it over.

- Check to make sure the battery is charged.
- After checking water level, be sure vent caps are in place. Don't use an open flame to check the battery.
- Make certain the battery retainers on both sides of the truck are properly installed.
- See that all wheels are in good condition.
- Clean the twist grips and hand holds.
- Make certain there are no objects placed or stored anywhere on the operator platform.
- Check that forks are not bent, cracked or badly worn.
- Look under the truck for signs of hydraulic leaks.
- Try the horn.
- Make sure the power disconnect works.
- Check that all controls work smoothly.

### 2. Test drive your truck in an uncongested area.

- Try all the hydraulic functions.
- Check the steering.
- Drive the truck slowly in both directions.
- Check braking distance in both directions. Load size and floor conditions can affect these distances.
- Drive through the full speed range in both directions.
- Know the distance it takes to stop before you start working. If the braking distance is too long to stop safely, don't drive the truck.
- Check parking brake operation.

**If anything doesn't look, work or feel right, don't drive the truck. Report the problem to your supervisor.**

*You can get checklist forms from your Crown dealer (part no. OF3772). Used properly, this checklist can alert service people to needed repairs.*

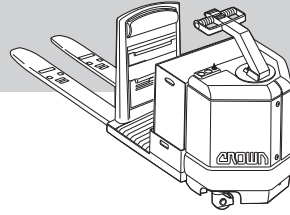

The most important component is you.

## MAKE SURE YOU ARE READY TO DRIVE

- Do not use this truck unless you are trained and certified.
- Be certain you understand how your truck works and the hazards that go with it. Don't drive the truck if you have any doubts.
- Know the capacity of your truck. Make certain you use the correct units of measure.
- Some trucks are not allowed in areas where there are fire hazards. Be certain your truck is the correct fire safety type for the area.
- Make sure your hands and shoes are clean and dry, and your clothing is proper for the job.

## MAKE SURE YOUR TRUCK IS READY

- Inspect your truck before using it (see pages 27 and 28). If it's not working right, or something is broken, report the problem to your supervisor. Don't use the truck.
- In an open area, test the braking. Check at a slow travel speed first, then a faster one. Know the distance it takes to stop before you start work.
- Make certain there are no objects stored anywhere on the operator platform. They would be a trip hazard and could affect truck speed.

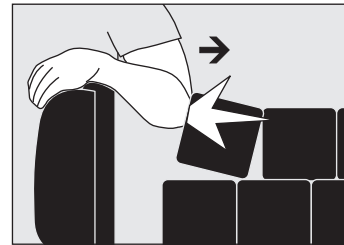
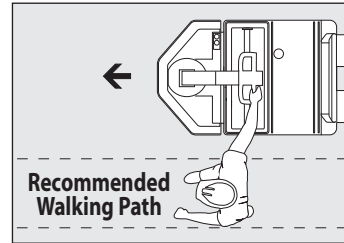

## WHEN USING COAST

- Travel power unit first only. Do not turn.
- Keep to the side of the truck. Make certain the truck won't hit the back of your leg or foot. Don't let the truck run over your foot.
- Be certain the area ahead of you is clear.

## WHEN RIDING

- Never stick a foot or any part of your body outside the operator area, no matter how slow the truck is moving.
- Don't put your hands or arms over the backrest. Keep your hands on the controls and feet on the platform.
- Stop your truck completely before getting off.

## DRIVE CAUTIOUSLY, BE ALERT

- Look where you are going. Don't let your hands or feet get pinned or crushed.
- Travel in the direction that gives you the best view. Slow down in congested areas.
- Slow down for wet or slippery floors. Don't run over things.
- Look where you are going before you change direction of travel.
- See that you have room to drive and turn. Watch out for power unit swing. Slow down when making turns.
- Avoid sudden movement of controls. Learn to use them smoothly at a moderate, even rate.
- Be extra careful if you must use your truck in an area where there is a risk of falling objects.

*Continued next page...*

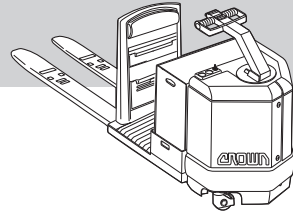

## WATCH OUT FOR OTHER PEOPLE

- Slow down. Yield or stop for pedestrians. Use your horn when you come to a crosswalk or intersection.
- Be careful that you don't pin or crush someone. *For example: Never drive your truck toward anyone standing in front of a fixed object.*
- Never allow passengers on your truck.
- Keep others away from your truck while you're working. Don't ever allow anyone to ride on the load or forks.
- Don't let anyone use your truck unless they are trained and certified.
- Don't allow the truck to coast in a congested area or if there are people in the aisle.
- Watch out for power unit swing.

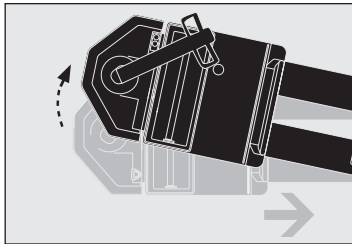

## WHEN LEAVING YOUR TRUCK

- Lower the forks. Turn the truck off or disconnect the battery.
- Wait for truck to come to a complete stop.
- Avoid parking on inclines. But if you must, block the wheels of your truck.

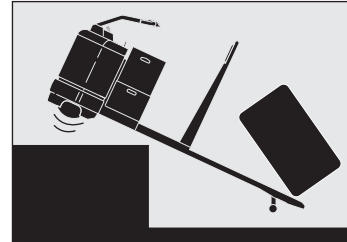

## AVOID FALLS

- Stay away from the edge of docks and ramps.
- Check that bridgeplates and dockboards are secure. Be certain that either the trailer wheels are chocked or the trailer is locked to the dock. Check capacities. Be sure your truck, with load, isn't too heavy for where you are driving.
- Make sure the load you are moving is stable. Center the load. Be even more careful with long, high or wide loads. They can be less stable.
- Don't drive onto an elevator unless you are authorized. Check the capacity or load limit and make sure there are no people present. Enter load first and come to a complete stop.

## BE CAREFUL TRAVELING ON RAMPS AND GRADES

- Always operate your truck from the rider position when traveling on a grade.
- With a load, drive with the forks pointed upgrade.
- Without a load, drive with forks downgrade.

**Slow down and don't turn on ramps or grades.**

# Battery Maintenance

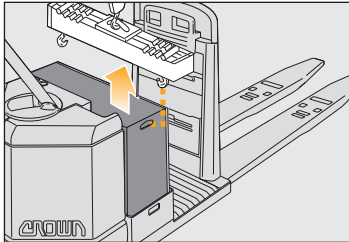
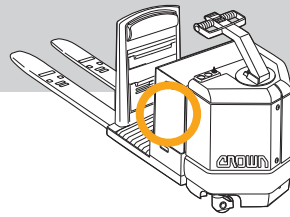

## WHEN YOU INSTALL OR CHANGE BATTERIES

- Turn the truck OFF. Check that all controls are in neutral and disconnect the battery.
- Make certain you use the correct size and weight battery. Never operate a truck that has an underweight or undersize battery installed.
- Never let anything metal touch the top of the cells. You could cause sparks or do damage to the battery. Use an insulator (such as plywood) when necessary.
- Use an approved spreader bar to place a battery in, or remove it from, the battery compartment or a stand. Make sure you adjust the spreader bar hooks to fit the battery.

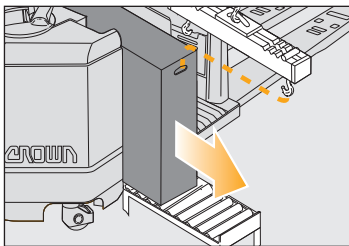

## USING A ROLLER STAND

If you use a roller stand to install or remove a battery make sure the roller stand is the same height as the rollers in the truck's battery compartment. Also make sure the roller stand is at least as long as your battery.

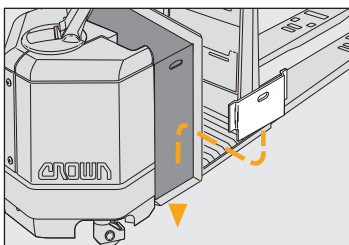

## AFTER INSTALLING YOUR BATTERY

- Replace the battery retainers. Make certain the retainers on both sides of the truck are in place.
- Connect the battery. Turn the truck ON and check truck operation.



## Know the Hazards

### ! DANGER



**Batteries produce explosive gas.**  
Do not smoke, use open flame, or create an arc or sparks near this battery. Ventilate well in enclosed areas and when charging.

Batteries contain **Sulfuric Acid** which causes severe burns. Do not get in eyes, on skin, or clothing. In case of contact, flush immediately. Get medical attention if your eyes are affected.

107

## TRUCK BATTERIES CAN BE DANGEROUS

Your truck battery produces a gas that can explode. It also contains acid that could burn or disfigure you.

- Do not try to install, remove, charge or service your truck battery unless you are trained and authorized.
- Never smoke or use an open flame around batteries.
- Your company should provide an area where it is safe to work on batteries. Use that area for all battery work.
- Use protective equipment such as gloves, eye shields, aprons etc.

## BATTERY RETAINERS MUST BE IN PLACE

The battery could slide out if retainers are not in place. Check that both retainers are installed before operating your truck.

## Know the Hazards

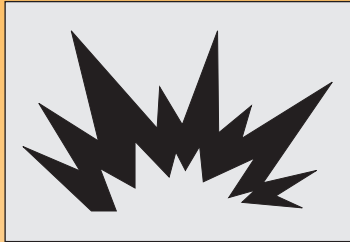

### BEFORE CHARGING YOUR TRUCK BATTERY

- Charge the battery only in areas designated for that use.
- Make sure the truck key switch is turned off and all other controls are in the off or neutral position.
- See that the battery cells are filled to the proper level. Never use an open flame to check the battery.
- Make certain the charger is the same voltage and amperage as your battery.
- Read the battery charger instructions.
- Be sure the charger is turned OFF before connecting the battery to the charger. Otherwise you might create a spark which could cause the battery to explode.

### BATTERY SIZE IS IMPORTANT

Make certain you use the correct size, type and weight of battery. Never operate a truck that has an underweight or undersize battery installed.

#### WARNING

**Minimum battery size allowed**  
**xxx mm (xx.xx in.) wide**  
**xxx mm (xx.xx in.) long**

Undersize battery can affect truck handling and stability. You could have an accident.  
Use U.L. classified Type E battery.

---

---

---

---

---

---

---

---

---

---

---

---

---

---

---

---

---

---

---

---

---

---

---

---







4500 SERIES

*This operator manual  
has information for all  
models of PC 4500 series  
plus some options and  
accessories. Some of the  
illustrations and information  
may not apply to your truck.*



*The most important component is you.*

---



New Bremen, Ohio 45869 USA © 2008 PF14948 Rev. 9/10

Printed in U.S.A.