



Operator Manual

This operator manual has information for all models of series B plus some options and accessories. Some of the illustrations and information may not apply to your truck.



The most important component is you.





WARNING

You must be trained and authorized to operate this truck.

You or others around you can be seriously injured or even killed if you don't use this truck correctly.

Read and obey all warnings and instructions in this Manual* and on the truck.

A dockboard can move or drop while you are on it. Or you could fall off a dock. Falls from docks or dockboards can cause serious injury or even death. **Make sure you are safe.**

Inspect your truck before starting work, make sure it is in good working order.

* Additional copies of this Operator Manual and all Truck Labels can be obtained from Crown Equipment Corporation, New Bremen, Ohio 45869 U.S.A.

All rights reserved under International and Pan American copyright conventions
Copyright 2002 Crown Equipment Corp.

You Must be Trained



YOU MUST BE TRAINED

ASME B56.10-1992 states that only authorized operators who have been properly trained are permitted to operate a manually propelled high lift industrial truck. Your employer must train you and should show that you are authorized to operate this lift truck.

Do not operate this truck in your work place until you have been trained and authorized by your employer.

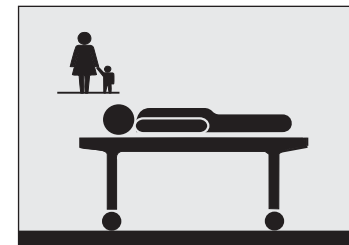
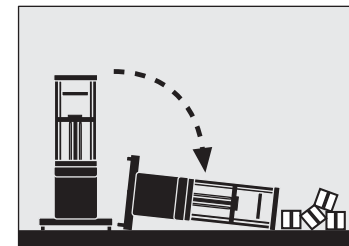

You could be killed or seriously injured if you are not adequately trained to operate this lift truck!

Protect Yourself

! Know the Hazards



USE YOUR TRUCK CAREFULLY, LOOK WHERE YOU'RE GOING

- Travel with the load or forks close to the floor. Stay away from inclines or sloping floors. To stop a loaded truck in an emergency, lower the forks to the floor, or carefully guide the truck into a wall or other solid object. Watch for shifting or falling loads.
- Watch your hands and your feet. Always be alert to the area around you and watch where you are walking. A foot or hand caught between the truck and a fixed object will be crushed or even cut off.
- Operate on level, smooth, dry floors. Do not operate on ramps or inclines. Do not run over objects on the floor.
- Keep your truck under control at all times. Move at a comfortable walking speed. Perform all truck movements smoothly and at a speed that will give you time to react in an emergency.
- While maneuvering the truck or moving power unit first, keep both hands on the push bar grips, and make certain the truck or wheels won't hit your legs or feet.



USE YOUR TRUCK SAFELY

- Keep your hands and feet away from all moving parts such as masts, chains, forks or wheels.
- Never stand on or under the forks, or allow anyone else to stand on or under them. The only way to lift people is with an approved platform. Never ride on the truck or allow anyone else to ride. There is no safe place to sit or stand.
- Before you leave your truck: lower the forks to the floor, apply the floor locks and disconnect the battery.

! Know the Hazards



AVOID FALLS AND TIPOVERS

- Tipovers and falls are very serious accidents, you can be crushed or even killed. The best way to prevent injury is to know where you are at all times and follow the rules of safe truck operation.
- Travel with the load or forks close to the floor. Watch for overhead obstructions. Perform all truck movements smoothly and at a speed that will give you time to react in an emergency.
 - Be extremely careful when working around docks, dockboards and trailers.
 - Stay away from the edge of docks and ramps. Do not operate this truck on ramps or inclines.
 - Make sure dockboards are secure.
 - Check that trailer wheels are chocked.
 - An unloaded truck can tip over also. You must be just as careful using an unloaded truck as you are using a loaded one.

Contents

What's in it for You?

Warning	1
You Must be Trained	2
Protect Yourself	3
Contents	5
What's in it for You?	6
Your Walkie Lift Truck	7
Lift Truck Parts	8
Capacity & Load Center	9
Capacity Plate	11
Traveling	13
Controls	15
Daily Safety Check	16
Be a Safe Operator	17
Battery Maintenance	20
Warning Labels	22

WHAT'S IN IT FOR YOU?

The better you understand your truck and how to use it, the better and safer operator you can be. Here are some guides to using this manual.

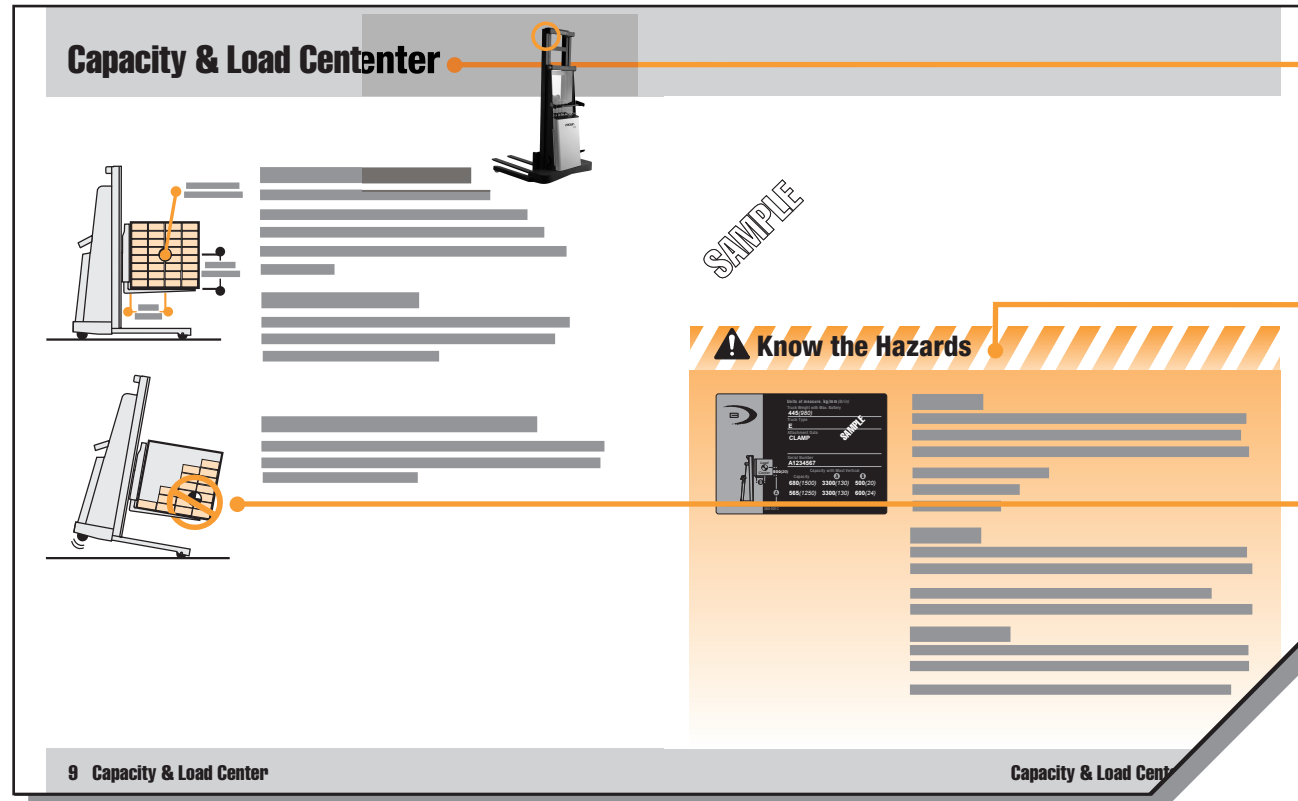

QUICK LOCATORS

In addition to the "Contents" page you can use page headings to find topics. Some pages also have a picture of the truck in the corner showing features or functions covered on that page.

"KNOW THE HAZARDS"

Watch for and read these special blocks. You will find information about possible safety hazards and how to avoid them.

HOW-TO-DRAWINGS

On many pages you will find pictures as well as text to help you understand how to use your truck safely and productively.

Your Walkie Lift Truck

WALKIE LIFT TRUCKS

Your walkie lift truck can be used to lift, move and stack loads. It can be pushed or pulled* for short distances over smooth, level floors. * With tow handle option.

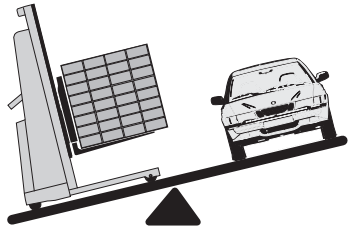

YOUR LIFT TRUCK IS NOT AN AUTOMOBILE

With a load it may weigh as much as a small automobile.

- You don't steer the same.
- You don't stop the same.

HOW TO OPERATE YOUR TRUCK

Standard Truck

Travel forks first with both hands on the push bar grips.

Watch your feet if you change direction of travel.

Truck With Tow Handle Option

Travel forks trailing, pulling the truck with the optional tow handle.

If the truck should begin to pick up speed, watch your feet. Get out of the way if you can't slow or stop the truck.

See pages 13 and 14 for more information.

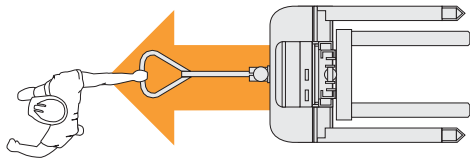
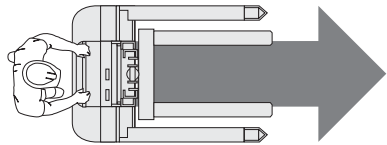

Lift Truck Parts

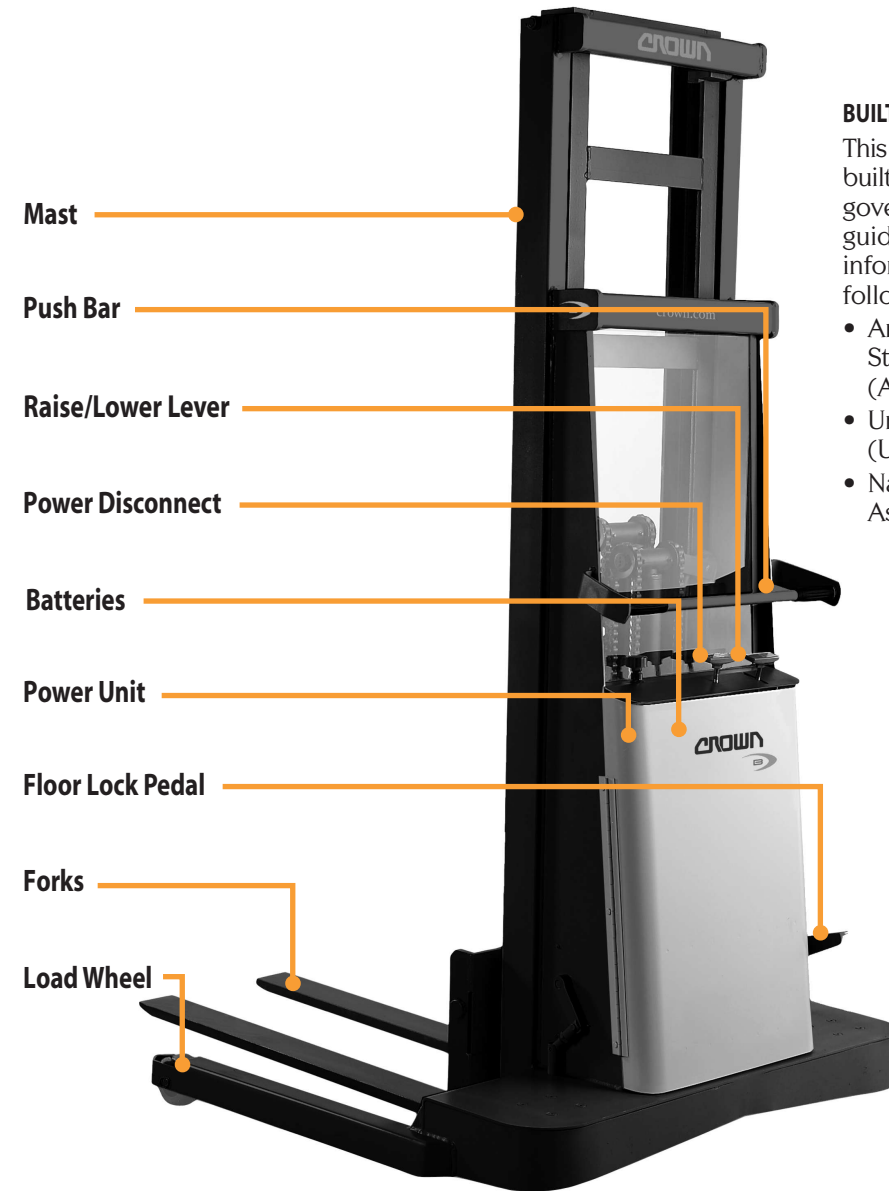

BUILT TO STANDARDS

This truck was designed and built to current industry and government standards and guidelines. For more information see the following:

- American National Standards Institute (ASME) B56.10
- Underwriters Laboratory (UL) 583
- National Fire Prevention Association (NFPA) 505

Capacity & Load Center

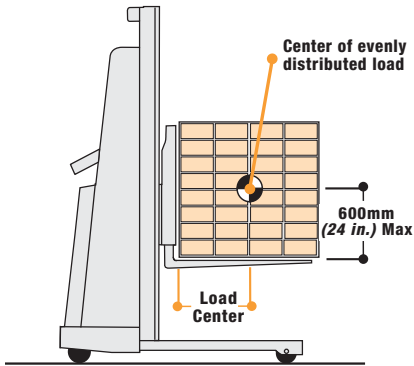

WHAT IS YOUR TRUCK CAPACITY?

Capacity is the load (including pallet or container) that can be lifted to a given height at a given load center. See the capacity plate on your truck. Make certain you use the correct units of measure.

WHAT IS LOAD CENTER?

Load center is the distance from the load backrest or vertical face of the fork to the center of an evenly distributed load.

LOADS MUST BE EVENLY DISTRIBUTED

Your truck could tip over, in any direction, if a load is shifted to the front or side of a pallet or container.

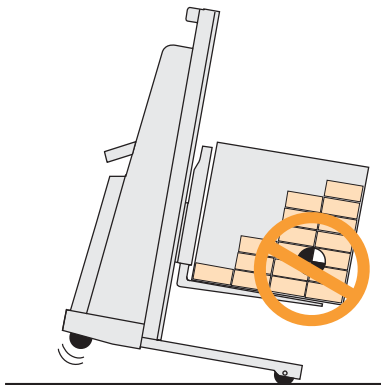

! Know the Hazards

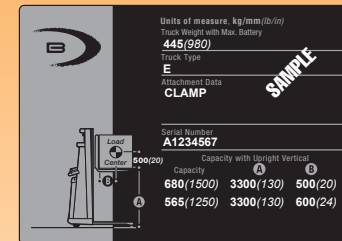

KNOW YOUR LOAD

Do not exceed the capacity shown on your truck's capacity plate. Be careful when handling long, high or wide loads. Do not handle unstable loads.

EXCEEDING TRUCK CAPACITY CAN CAUSE AN ACCIDENT

Know the capacity of your truck as shown on your capacity plate. Use the correct units of measure. Pay attention to:

- Weight of load
- Load center
- Lift height

CENTER THE LOAD

Your truck could tip over if a load is shifted to the front or side of a pallet or container. Make sure your load is evenly distributed and centered over the forks.

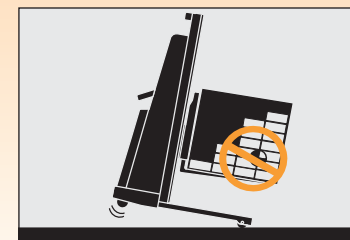

Capacity Plate



CAPACITY PLATE INFORMATION

The capacity plate is on the power unit cover. It contains:

- Serial number
- Capacity information (load, load center and lift height)
- Truck type (a fire safety rating)
- Truck weight with battery (does not include load)
- Attachment information (if any)

READING YOUR CAPACITY PLATE

The capacity plate on the console contains the load, load center, and lift height ratings for your truck.
*For example: On the sample plate, 680kg (1500 lb) can be lifted to **A** 3300mm (130 in) at a **B** 500mm (20 in) load center.*

Capacity is reduced as load center **B** increases.
For example: On the sample plate, 680kg (1500 lb) can be lifted if the load center is 500mm (20 in). But if the load center is increased to 600mm (24 in), capacity is reduced from 680kg (1500 lb) to 565kg (1250 lb).

SAMPLE CAPACITY PLATE
 The information shown on this sample plate does not apply to your truck.

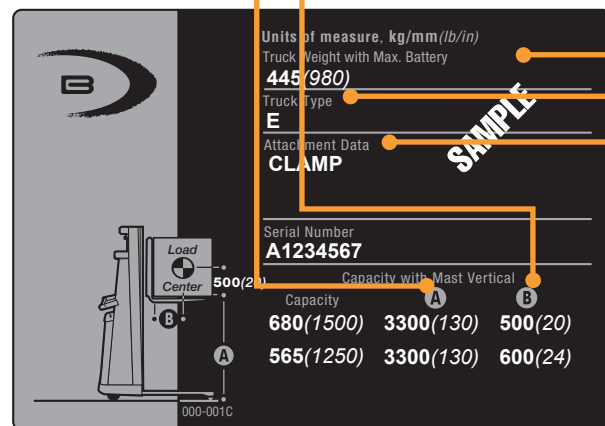

CAUTION

You may not increase capacity if load center is less than shown on your capacity plate.

Note: ANSI requires that all data be shown first in Metric units and then USA units.

OTHER LIFT HEIGHTS & LOAD CENTERS

Contact Crown for capacities at lift heights or load centers not given on your capacity plate.

Know the Hazards

TRUCK WEIGHT

Dockboards, elevators and some floors have limited capacity. Check your capacity plate for the weight of your truck. Remember to add the weight of the load you have on the forks. Make certain you use the correct units of measure.

TRUCK TYPE

Some truck types are not permitted in areas where there are fire hazards. Watch for marked areas. *For example: You must not operate a type E or ES truck in an area restricted to EE or EX trucks.*

ATTACHMENT DATA

If an attachment on your truck does not match the information given here on your capacity plate, don't operate your truck. Your capacity plate may be wrong. Report the problem to your supervisor, or contact Crown.

Traveling

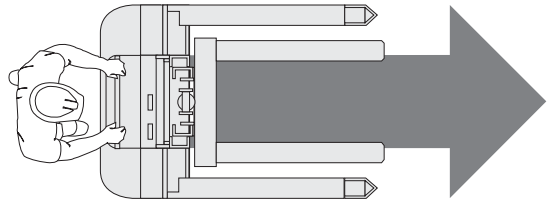

TRAVELING, STANDARD TRUCK

Travel forks first with both hands on the push bar grips.
Travel with the load and forks close to the floor. To stop your truck in an emergency, lower the forks to the floor.
When maneuvering or moving the truck for very short distances, it may be necessary to travel forks trailing.
Keep both hands on the push bar grips and make certain your feet are clear of the truck and wheels.
Don't run over objects on the floor.

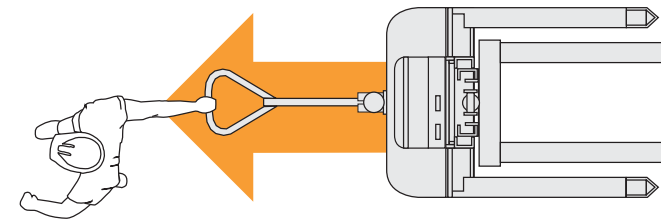

TRAVELING, TOW HANDLE OPTION

Travel forks trailing, pulling the truck with the optional tow handle.
Travel with the load and forks close to the floor. To stop your truck in an emergency, lower the forks to the floor, or carefully guide the truck into a wall or other solid object. Watch out for a shifting or falling load.
If the truck should begin to pick up speed, watch your feet. Get out of the way if you can't slow or stop the truck.

! Know the Hazards



LOOK WHERE YOU'RE GOING, KEEP YOUR FEET CLEAR

Always be alert to the area around you and watch where you are walking. You could be pinned if you are caught between the truck and walls, racks or other fixed objects. A foot or hand could be crushed or even cut off.
Keep your feet clear of the truck and wheels.
Stay away from the edge of docks and ramps.
Watch where you're going and check the floor around you for obstructions.

! Know the Hazards



NEVER USE THIS TRUCK ON AN INCLINE

Always travel with the load close to the floor. To stop your truck in an emergency, lower the forks to the floor, or carefully turn the truck into a wall or solid object.
An incline or sloping floor can cause the truck to move faster than your walking speed.
Watch your feet if the truck picks up speed. If you can't stop the truck or slow it down, get out of the way.
Sudden stops can cause the load to shift or fall. Protect yourself and warn other people in the area.

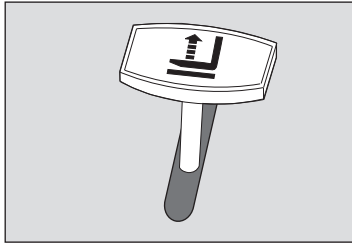

RAISE/LOWER

Move the Raise/Lower lever away from the mast, toward the push bar, to raise the forks. Move the lever toward the mast to lower the forks.

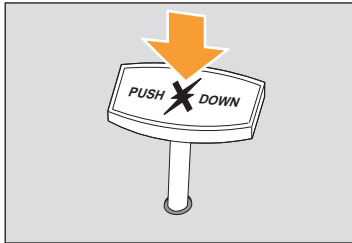

POWER DISCONNECT

Push the battery connector handle down to disconnect the battery and cut all power.

Always disconnect the battery any time the truck isn't working right. The key switch does not cut all power to the truck.

Don't use the truck if it's not working right. Report the problem to your supervisor.

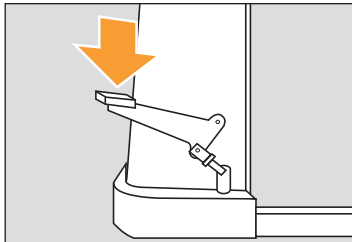

DUAL FLOOR LOCKS

Step down all the way on the foot pedal to apply the floor locks. Use the floor locks whenever you leave your truck, or anytime you don't want the truck to move unintentionally.

CHECK YOUR TRUCK BEFORE STARTING WORK

You must make sure your truck is safe to use.

1. Walk around your truck and check it over.

- Check to make sure the batteries are charged, water level is OK and vent caps are in place. Don't use an open flame to check the batteries.
- See that all wheels are in good condition.
- Check that both forks are secure and not bent, cracked or badly worn.
- Inspect lift chains for damage.
- Clean the safety shield and keep it clear. Clean the push bar and grips.
- See that the load backrest is in place and secure, if your truck has that option.
- Look under the truck for signs of hydraulic leaks.
- Make sure the power disconnect works.
- Check that the floor locks are working properly.

2. Test your truck in an uncongested area.

- Check raise and lower.
- Make certain you know how much effort is required to slow the truck down, and to stop it.

If anything doesn't look, work or feel right, don't use the truck. Report the problem to your supervisor, or contact Crown.

You can get checklist forms from your Crown dealer (part no. OF-3772). Used properly, this checklist can alert service people to needed repairs.

Be a Safe Operator

*The most
important
component
is you.*



MAKE SURE YOU AND YOUR TRUCK ARE READY

- Do not use this truck unless you are trained and authorized.
- Be certain you understand how your truck works and the hazards that go with it. Don't use the truck if you have any doubts.
- Know the capacity of your truck. Make certain you use the correct units of measure.
- Be sure you know how to stop or slow down your truck in an emergency.
- Some trucks are not allowed in areas where there are fire hazards. Be certain your truck is the correct fire safety type for the area.
- Make sure your hands and shoes are clean and dry, and your clothing is proper for the job.
- Inspect your truck before using it (see page 16). If it's not working right, or something is broken, report the problem to your supervisor. Don't use the truck.

USE CAUTION, BE ALERT

- Travel with the forks and load close to the floor. Place the load against the load backrest or vertical face of the forks.
- Stay away from ramps, slopes and grades.
- Watch where you're walking. Don't let any part of your body get pinned or crushed between the truck and a fixed object.
- Slow down for wet or slippery floors. Don't run over things. Watch out for rough or uneven floors.

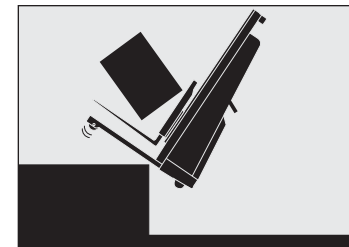

- Look where you are going before you change direction of travel.
- Slow down when making turns, and see that you have room to turn.
- Check clearances before raising or lowering the forks or load.
- Be extra careful if you must use your truck in an area where there is a risk of falling objects.
- Never ride on your truck.

AVOID FALLS

- Stay away from the edge of docks.
- Check that bridgeplates and dockboards are secure. Be certain that either the trailer wheels are chocked or the trailer is locked to the dock. Check capacities. Be sure your truck, with load, isn't too heavy for where you are operating.
- Make sure the load you are moving is stable. Spread the forks as far as you can and center the load. Insert the forks as far under the load as you can. Be even more careful with long, high or wide loads. They can be less stable.
- Don't take your truck onto an elevator unless you are authorized. Check the capacity or load limit and make sure there are no people present. Enter load first and set the floor locks.

DO NOT TRAVEL ON RAMPS OR GRADES

Continued next page...

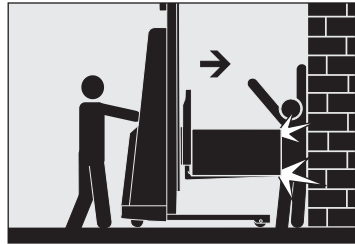

WATCH OUT FOR OTHER PEOPLE

- Slow down. Watch out for pedestrians and warn them of your presence.
- Be careful that you don't pin or crush someone. For example: Never move your truck toward anyone standing in front of a fixed object.
- Never allow anyone to ride on your truck.
- Keep others away from your truck while you're working. Don't ever allow anyone on or under the load or forks.
- Don't let anyone use your truck unless they are trained and authorized.
- Never lift anyone with the forks unless they are using an approved platform. Even then use extreme caution:
 - Use a securely attached and approved safety platform.
 - Make certain lifting mechanism is operating properly.
 - Apply the floor locks.
 - Lift and lower slowly.
 - Watch for overhead obstructions.
 - Be sure you can see and hear the person being lifted.
 - Never transport anyone on the platform from one location to another.

WHEN LEAVING YOUR TRUCK

- Lower the forks to the floor.
- Apply the floor locks and disconnect the battery.

BATTERIES

Your truck has two automotive style batteries. You must check the batteries daily.

CHARGERS

Your truck has a built-in charger. The charger must be plugged into an AC electrical outlet before charging. Make certain the charger and the AC outlet are the same voltage. Follow the directions on your charger.

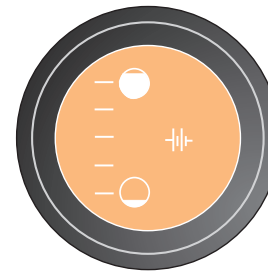

BATTERY CHARGE METER OPTION

The lighted bar shows how much charge is left in your batteries. A flashing light will warn you that the batteries are getting low. Two flashing lights mean you must have the batteries changed or recharged.

Continued next page...

Know the Hazards

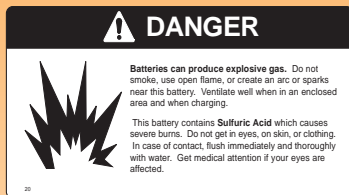

BATTERIES CAN BE DANGEROUS

Your truck batteries produce a gas that can explode. They also contain acid that could burn or disfigure you.

- Never smoke or use an open flame around batteries.
- Do not try to install, remove, charge or service your truck batteries unless you are trained and authorized.
- Your company should provide an area where it is safe to work on batteries. Use that area for all battery work.
- Use protective equipment such as gloves, eye shields, aprons, etc.
- See that the battery cells are filled to the proper level. Never use an open flame to check the battery.
- For a built-in charger, make certain the AC outlet is the same voltage as your charger.
- Read and follow the battery charger instructions.
- Be sure the charger is turned OFF before connecting the batteries to the charger. Otherwise you might create a spark which could cause a battery to explode.
- Make sure all controls are in the off or neutral position.
- Leave battery door open while charging.
- Avoid using extension cords. But if you must, follow the recommendations on your battery charger.



EACH WARNING LABEL ON YOUR TRUCK IS IMPORTANT

Read and obey all of them to protect yourself and others.

