

This operator manual has information for all models of series TSP plus some options and accessories. Some of the illustrations and information may not apply to your truck.



The most important component is you.

WARNING

It's the law, you must be trained and certified to operate this truck. (OSHA § 1910.178, Rev. 1999)

You or others around you can be seriously injured or even killed if you don't use this truck correctly.

Read and obey all warnings and instructions in this Manual* and on the truck.

Falling from a platform can cause serious injury or death. **Put on the operator harness and attach tether before operating the truck.**

Head, arms, hands, legs or feet outside the operator area can be pinned or crushed whenever the truck is moving. Stay within the operator area and **stop the truck completely before getting off.**

A dockboard can move or drop while you are on it. Or you could drive off a dock. Falls from docks or dockboards can cause serious injury or even death. **Make sure you are safe.**

Inspect your truck before starting work, make sure it is in good working order.

* Additional copies of this Operator Manual and all Truck Labels can be obtained from Crown Equipment Corporation, New Bremen, Ohio 45869 U.S.A.

All rights reserved under International and Pan American copyright conventions
Copyright 1997 Crown Equipment Corp.

You Must be Trained



IT'S THE LAW, YOU MUST BE TRAINED AND CERTIFIED

Federal law states that only properly trained operators are permitted to operate a powered industrial truck and that your employer must train you and certify that you are qualified to operate this powered industrial truck. (OSHA §1910.178, Rev. 1999)

Do not operate this truck in your work place until you have been trained and certified by your employer.

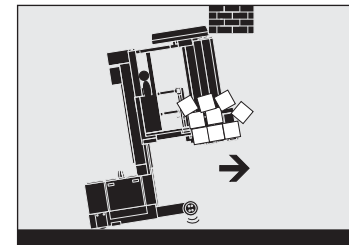

You could be killed or seriously injured if you are not adequately trained for lift truck operation!

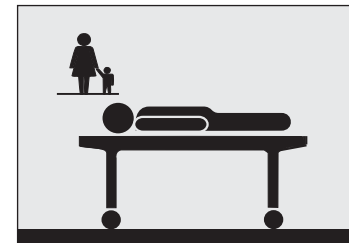

Protect Yourself

! Know the Hazards

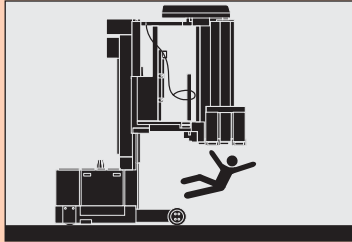

WEAR YOUR OPERATOR HARNESS

Falls from a platform can cause serious injury or even death.

- Use your operator harness and tether when elevated and working with an open side gate. Read the warnings on the harness.
- Check your harness and tether. Replace them if they have ever been used to stop a fall, or if damaged or worn.

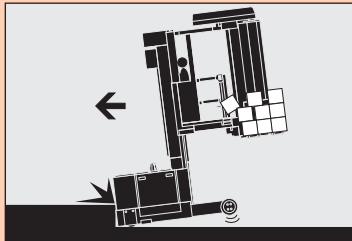

LOOK WHERE YOU'RE DRIVING

- If you run into things you can be injured. You could fall from the truck or the load could shift and hit you. Make certain there is nothing in your path, on the floor or sticking out of the racks.
- Always be alert to the area around you and watch where you are driving. You could be pinned or crushed by objects intruding or poking into the operator area.

DRIVE CAREFULLY

- Keep your hands on the controls and feet on the pedals. Keep your entire body in the operator area. A foot or hand caught between the truck and a fixed object will be crushed or even cut off.
- Keep your truck under control at all times. Drive at a speed that allows you to stop safely. Be even more careful on slippery or uneven surfaces. Do not drive over objects on the floor.

CHECK YOUR LOADS

Before you pivot a load, make certain it won't intrude or poke into the operator area. Do not handle long, wide or unstable loads. Check clearances before using traverse.

! Know the Hazards

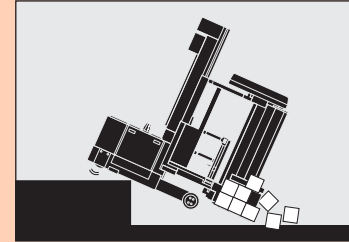

AVOID FALLS AND TIPOVERS

Tipovers are very serious accidents, you can be crushed or even killed. The best way to prevent injury is to know where you are at all times and follow the rules of safe truck operation. There is no sure way to avoid injury during a tipover or a drop from a dock.

- Be careful if driving around docks or ramps. Stay away from the edge. Watch where you're going.
- When traveling out of the aisle, keep the forks or load close to the ground. Watch for overhead obstructions. Perform all truck movements smoothly and at a speed that will give you time to react in an emergency.
- Turret Stockpickers should not be used on ramps or grades. If you must drive on a grade, travel slowly and don't turn. If carrying a load, point the forks upgrade. If unloaded, point the forks downgrade.
- An unloaded truck can also tip over. Be just as careful using an unloaded truck as you are using a loaded one.

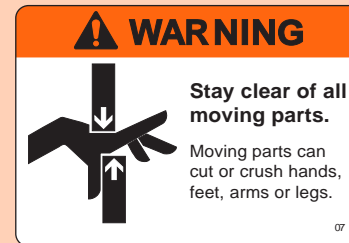

USE YOUR TRUCK SAFELY

- Keep hands and feet away from all moving parts such as masts or wheels. Don't sit or stand on the side gates.
- Never stand on or under the forks, or allow anyone else to stand on or under them. Never allow passengers on the truck. There is no safe place for them.
- Before you leave your truck:
 - Come to a complete stop.
 - Lower the forks to the floor.
 - Shut the truck off with the key or power disconnect.
 - Apply the parking brake.

Contents

Warning	1
You Must be Trained	2
Protect Yourself	3
Contents	5
What's in it for You?	6
Your Turret Stockpicker	7
Turret Truck Parts	9
Capacity & Load Center	11
Capacity Plate	13
Display Panel	15
Power On & Off	17
Sit or Stand Operation	18
Foot Brake & Parking Brake	19
Platform Safety	21
Traverse, Extend & Pivot	23
Raise & Lower	25
Steering & Travel	27
Traveling & Plugging	29
Wire Guidance Option	31
Daily Safety Check	33
Be a Safe Driver	35
Battery Maintenance	39
Warning Labels	42

What's in it for You?

WHAT'S IN IT FOR YOU?

The better you understand your truck and how to use it, the better and safer operator you can be. Here are some guides to using this manual.

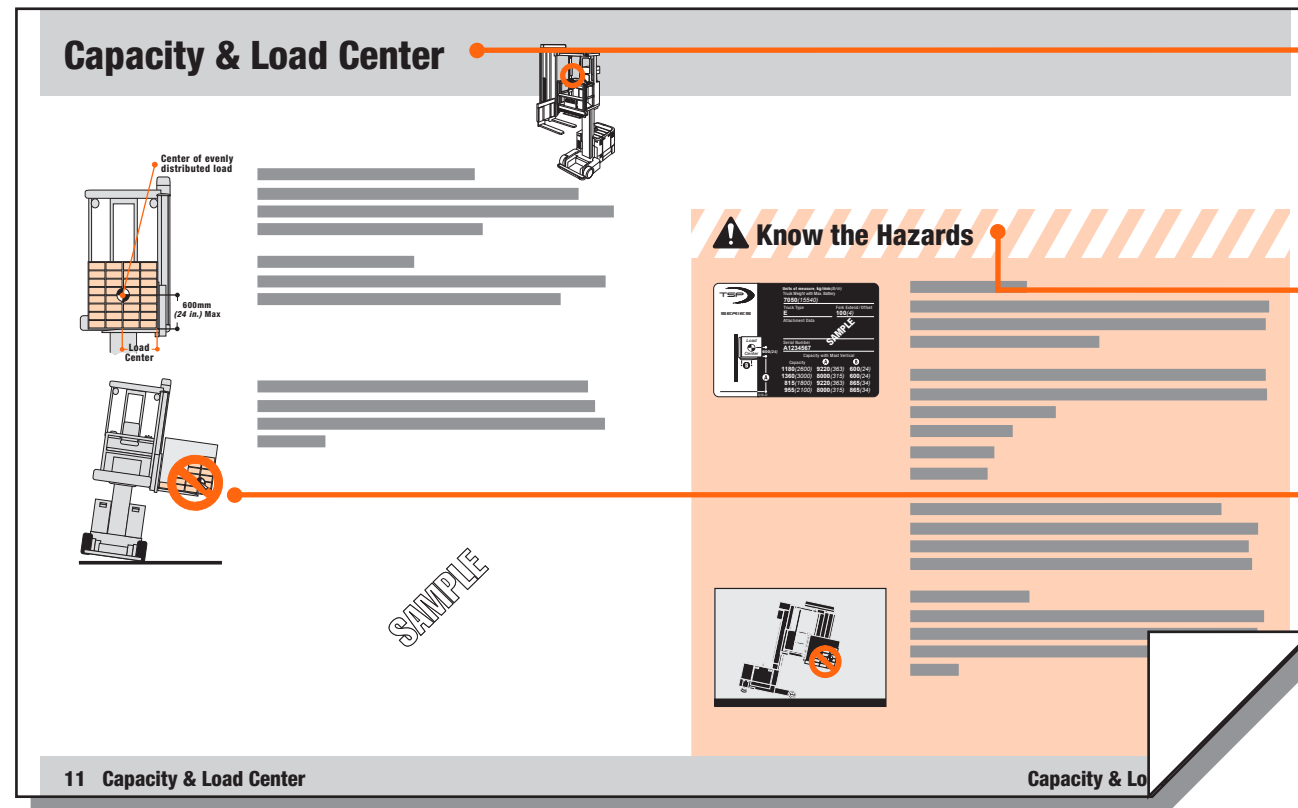

QUICK LOCATORS

In addition to the "Contents" page you can use page headings to find topics. Some pages also have a picture of the truck in the corner showing features or functions covered on that page.

"KNOW THE HAZARDS"

Watch for and read these special blocks. You will find information about possible safety hazards and how to avoid them.

HOW-TO-DRAWINGS

On many pages you will find pictures as well as text to help you understand how to use your truck safely and productively.

Your Turret Stockpicker

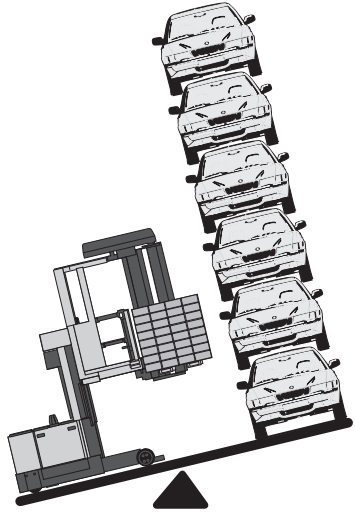

TURRET STOCKPICKERS

Your turret truck is designed to transport, stack and retrieve loads.

YOUR TURRET TRUCK IS NOT AN AUTOMOBILE

With a load it may weigh more than 6 automobiles.

- You don't steer the same.
- You don't brake the same.
- You don't accelerate the same.

HOW TO DRIVE YOUR TRUCK

Put the side gates down. Keep your hands and feet inside the operator compartment and on the controls. Look in the direction you're going.

WHEN TO USE THE HARNESS AND TETHER

Wear your harness and attach the tether whenever the operator compartment is elevated and you have a side gate open. (The harness may be either a belt or a body harness.)

GIVE YOUR BODY A BREAK

Take advantage of stop time. Flex your arms and legs. Staying alert will help you be a better and safer driver.

BUILT TO STANDARDS

This truck was designed and built to current industry and government standards and guidelines. For more information see the following:

- American National Standards Institute (ASME) B56.1
- Occupational Safety and Health Act (OSHA) §1910.178 Rev. 1999
- Underwriters Laboratory (UL) 583
- National Fire Prevention Association (NFPA) 505

Hands on controls

Side gates down

Feet on pedals

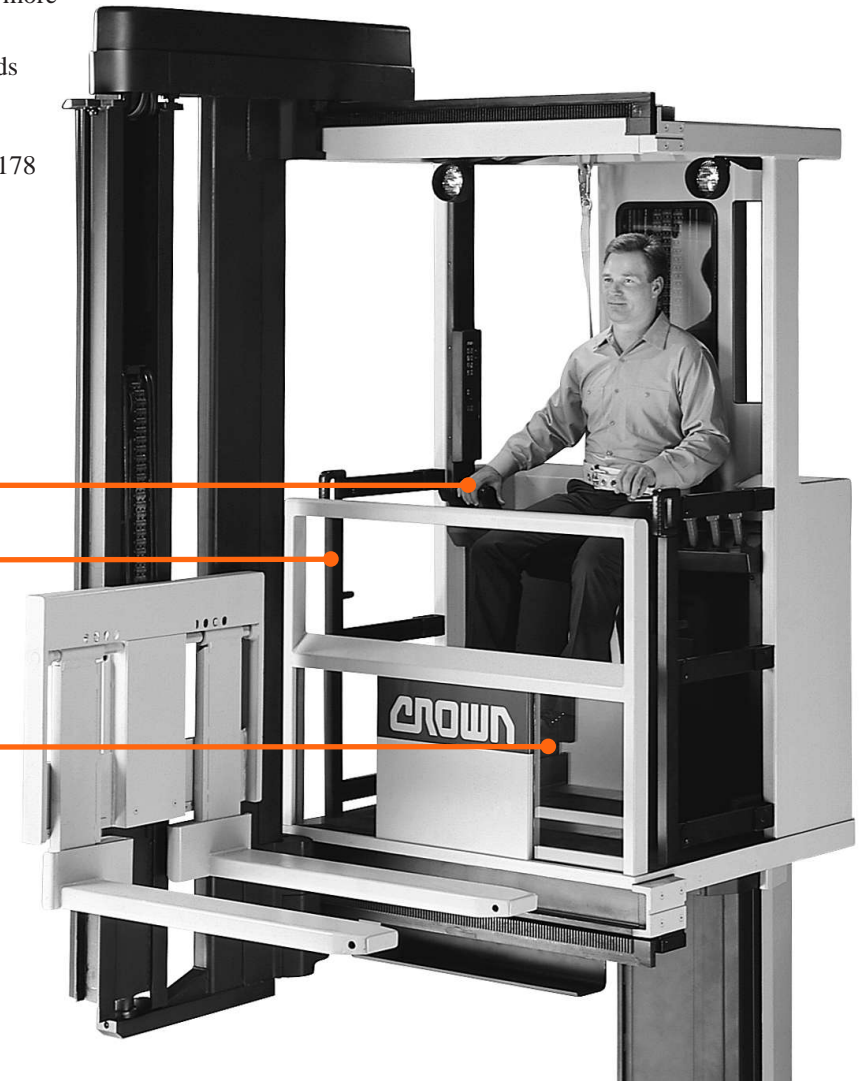

Turret Truck Parts

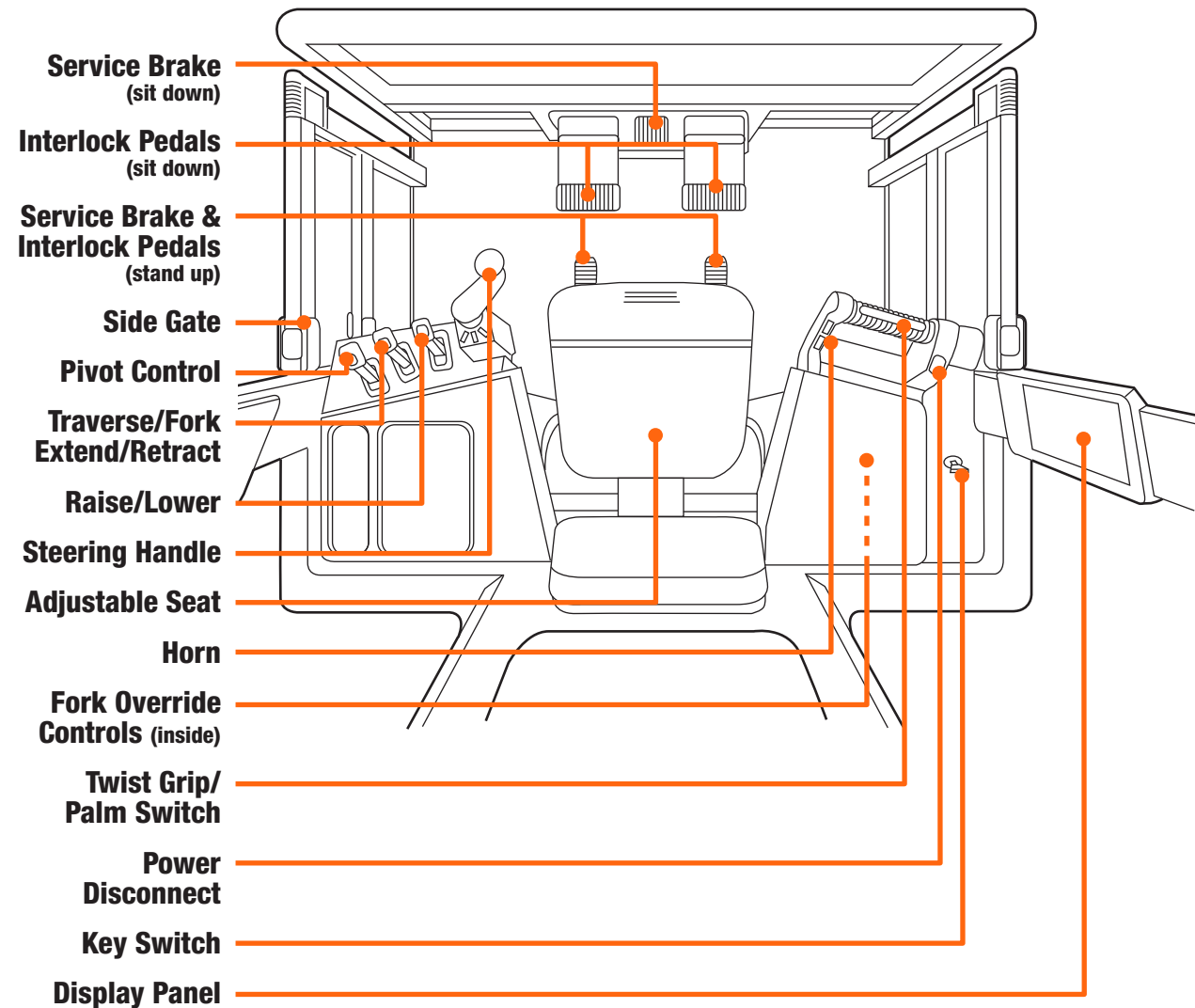
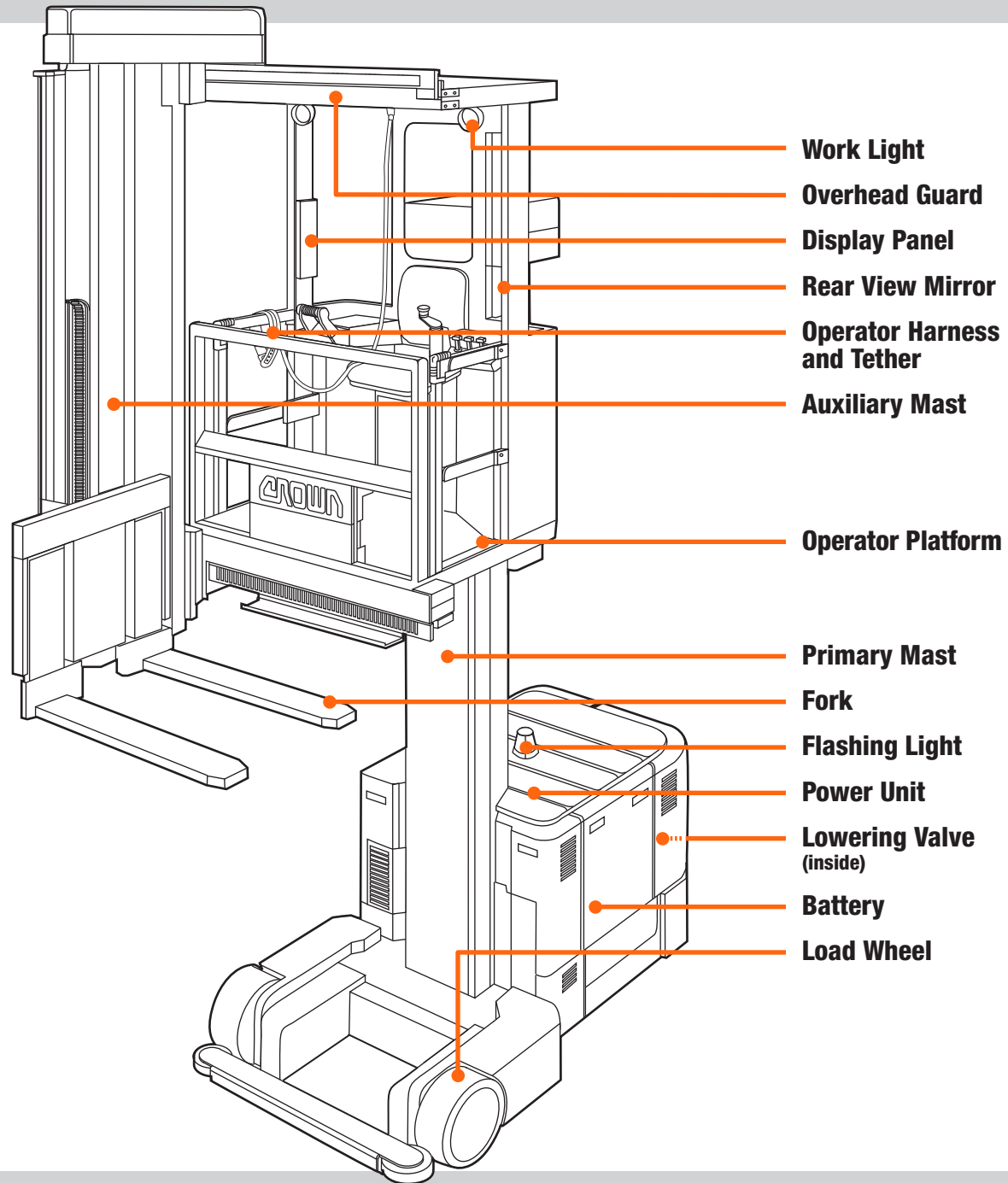

Capacity & Load Center

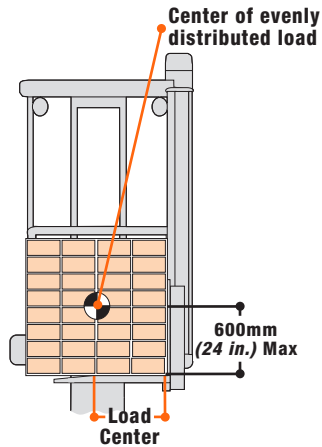
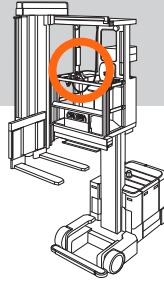

WHAT IS YOUR TRUCK CAPACITY?

Capacity is the load (including pallet or container) that can be lifted to a given height at a given load center. See the capacity plate on your truck. Make certain you use the correct units of measure.

WHAT IS LOAD CENTER?

Load center is the distance from the vertical face of the forks to the center of an evenly distributed load.

LOADS MUST BE CENTERED & EVENLY DISTRIBUTED

Your truck could tip over, in any direction, if a load is placed or shifted to the front, back or side of a pallet or container.

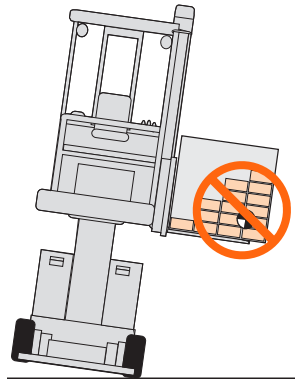

! Know the Hazards

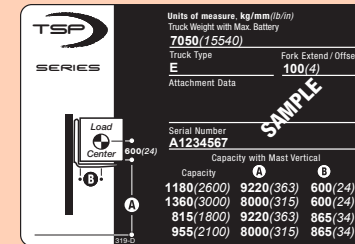

KNOW YOUR LOAD

Do not exceed the capacity shown on your truck's capacity plate. Be careful when handling long, high or wide loads. Do not handle unstable loads.

EXCEEDING TRUCK CAPACITY CAN CAUSE AN ACCIDENT

Know the capacity of your truck as shown on your capacity plate. Make certain you use the correct units of measure. Pay attention to:

- Weight of load
- Load center
- Lift height

HYDRAULIC OPERATIONS CAN AFFECT STABILITY

Be careful when using operations such as traverse, extend or pivot. Remember that anytime the forks move, the load moves also. This can affect stability. Perform all operations smoothly.

CENTER THE LOAD

Your truck could tip over if a load is placed or shifted to the front, back or side of a pallet or container. Make sure your load is evenly distributed and centered over the forks.

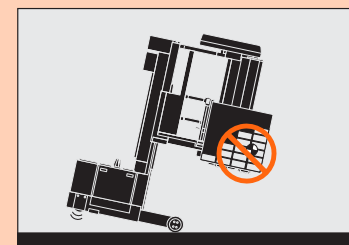

Capacity Plate

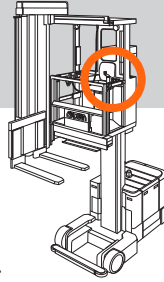

CAPACITY PLATE INFORMATION

The capacity plate is by the steering handle. It contains:

- Truck serial number
- Capacity information (load, load center and lift height)
- Truck type (a fire safety rating)
- Truck weight with battery (does not include load)
- Attachment information (if any)

READING YOUR CAPACITY PLATE

Capacity may be reduced as lift height **A** increases. For example: On the sample plate, 1360kg (3000 lb) can be lifted to 8000 (315 in). But above 8000 (315), to 9220 (363), capacity is reduced from 1360 (3000) to 1180 (2600).

Capacity is reduced as load center **B** increases. For example: On the sample plate, 1360kg (3000 lb) can be lifted if the load center is 600mm (24 in). But if the load center is increased to 865mm (34), capacity is reduced from 1360 (3000) to 955 (2100).

CAUTION

You may not increase capacity if load center is less than shown on your capacity plate.

Note: ANSI B56.1 requires that all data be shown first in Metric units and then USA units.

OTHER LIFT HEIGHTS AND LOAD CENTERS

Contact Crown for capacities at lift heights or load centers not given on your capacity plate.

SAMPLE CAPACITY PLATE
The information shown on this sample plate does not apply to your truck.

Units of measure, kg/mm (lb/in)		
Truck Weight with Max. Battery 7050(5540)		
Truck Type	Fork Extended / Offset	
E	100(4)	
Attachment Data		
Serial Number A1234567		
Capacity with Mast Vertical		
Capacity	A	B
1180(2600)	9220(363)	600(24)
1360(3000)	8000(315)	600(24)
815(1800)	9220(363)	865(34)
955(2100)	8000(315)	865(34)

Know the Hazards

TRUCK WEIGHT

Some floors have limited capacity. Check your capacity plate for the weight of your truck. Remember to add the weight of the load you have on the forks. Make certain you use the correct units of measure.

TRUCK TYPE

Some truck types are not permitted in areas where there are fire hazards. Watch for marked areas. For example: You must not drive a type E or ES truck into an area restricted to EE or EX trucks.

Display Panel

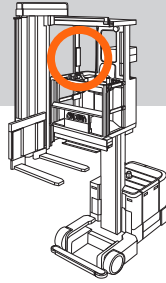

TRAVERSE/EXTEND LIGHT

Green light on when the forks and auxiliary mast are in the travel position.

PIVOT LIGHT

Green light on when the forks are pivoted to the travel position.

SERVICE LIGHT

Amber light on when something needs to be fixed. Report the trouble to your supervisor, even if the truck seems to be working OK.

GATE LIGHT

Red light on when a gate is up.

PALM/FOOT SWITCH LIGHT

Amber light on when the proper palm switch or foot pedal is not actuated.

CALIBRATION INDICATOR LIGHT

RAISE/LOWER CUTOUT LIGHT

Red light on when forks are at preset raise or lower limits.

LOW SIGNAL STRENGTH LIGHT

Amber light on when signal from guidance wire is low.

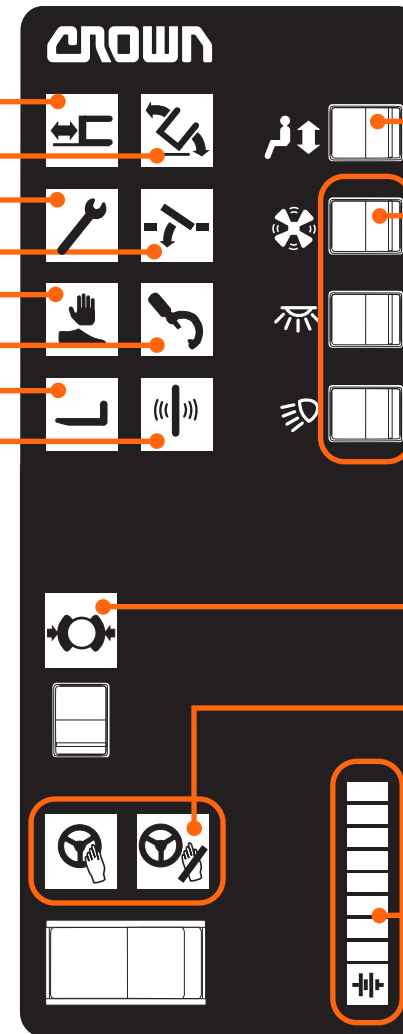

SEAT ADJUSTMENT SWITCH

Move seat up or down.

ACCESSORY SWITCHES

Fan, dome light and work lights.

PARKING BRAKE LIGHT

Amber light on when parking brake is applied.

GUIDANCE LIGHTS, OPTION

- Green light on when guidance has control of steering. Start slowly.
- Red light on when guidance is on but truck is not on the wire. Steer manually.

BATTERY CHARGE DISPLAY

The green bars show how much charge is left. Have the battery changed or recharged when you see a flashing yellow light.

Power On & Off

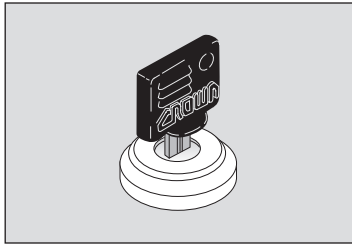
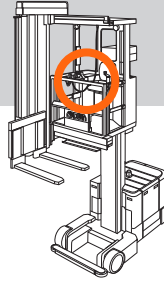

KEY SWITCH

- Turn the key clockwise as far as it will go, to the TEST position. Check that the alarm and all indicator lights are working.
- Let go of the key and it will return to the ON position.
- Turn the key back to the OFF position to shut the truck off. Always turn the key to OFF when leaving the truck.

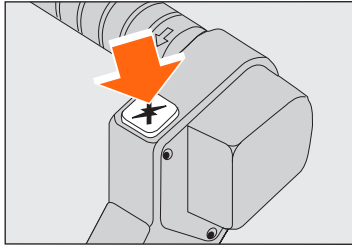

POWER DISCONNECT

Push the Power Disconnect button to disconnect the battery and cut power to the truck. The brake will also be applied.

Always use the Power Disconnect if your truck isn't working right. Don't operate the truck. Report the problem to your supervisor.

Turn the key switch to OFF and back to TEST to reconnect the battery.

Sit or Stand Operation

SIT/STAND OPTION

You have the choice of putting the seat down to drive your truck from a seated position, or flip the seat up to drive from a standing position.

THERE ARE SOME DIFFERENCES

The foot brake and the foot interlock pedals do not work the same for the two operating positions.

- For instructions on use of the foot brake, see pages 19 and 20.
- For instructions on use of the interlock pedals, see pages 21 and 22.

Foot Brake & Parking Brake

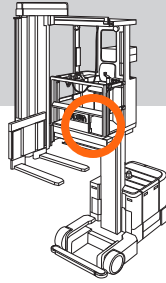

FOOT BRAKE PEDALS

The platform has foot brake pedals at two locations. One location is for a seated position and one is for a standing position. Brake operation is not the same from the two positions. Be careful.

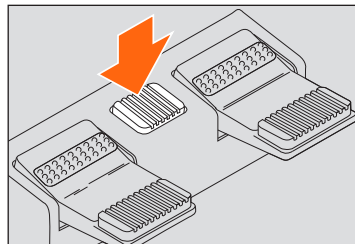

SEATED POSITION

Press the center pedal on the pedestal to apply the brakes.

The pedestal brake pedal works only while you are seated. Use the floor brake pedals if you operate your truck from a standing position.



STANDING POSITION

Lift or remove your foot from either of the floor brake pedals to apply the brakes. Both of the floor pedals must be down for the truck to operate.

The floor brake pedals work only while you are standing. Use the pedestal brake pedal if you operate your truck from a seated position.

Note: Whenever you apply the brakes, power is cut to the drive motors, so you cannot stop or slow your truck down by using plugging (see page 29).

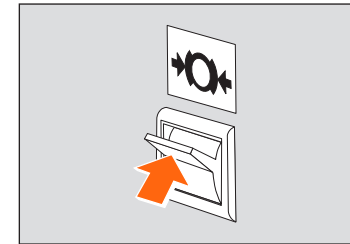

PARKING BRAKE

Move the switch up to apply the parking brake. The indicator above the switch will light when the brake is on.

Some service conditions will also set the parking brake.

Always put the parking brake on when you leave the truck.

Move the switch down to release the brake.

! Know the Hazards

SEATED BRAKING VS STANDING BRAKING

The brakes do not work the same from the two operating positions. When seated, you step down on a pedal to activate the brakes. However when standing, you remove a foot from a pedal to activate the brakes. Stay alert, especially when changing operating positions.



MAKE SURE YOUR BRAKES WORK

Test your brakes at the start of each shift. Know the distance it takes to stop before you start working. If the stopping distance is too long for you to stop safely, don't drive the truck. Report any problem to your supervisor.

Platform Safety

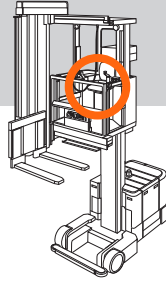

KEEP THE SIDE GATES DOWN

- Keep the side gates down unless you are leaving the truck or picking from the side. The truck will not operate with a gate up.
- Don't sit or climb on the side gates.
- Keep your entire body in the operator area.

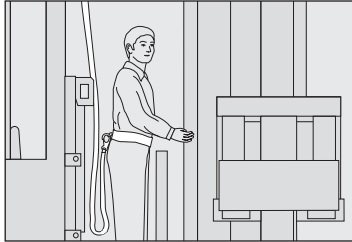

HARNES AND TETHER

Use your harness and tether whenever you are working from a raised platform and have a side gate open.

Check the harness, tether, snap hooks and mounting points daily for wear or breakage. If it doesn't look safe don't use the truck. Report the problem to your supervisor.

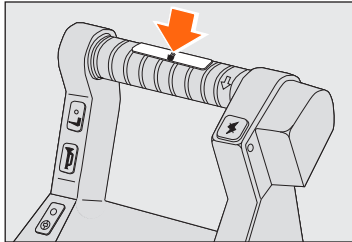

PALM SWITCH

The travel twist grip has an interlock switch built into the top of it.

You must have your hand, or palm, on the top of the twist grip for the following load handling functions to operate:

- Auxiliary raise or lower
- Traverse
- Extend or retract
- Pivot

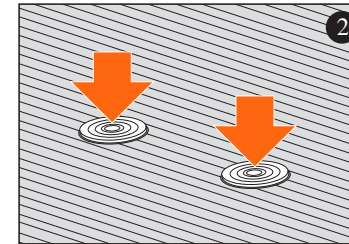
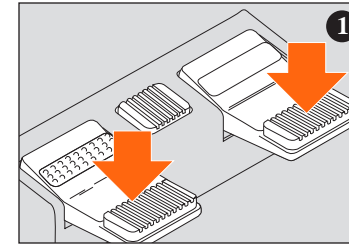

INTERLOCK PEDALS

The platform has two sets of foot operated interlock pedals.

- ① One set, located on the pedestal, is for seated operation.
- ② The second set, on the floor, is for standing operation. You also use these floor pedals for braking while in the standing position. (See page 20)

You must have your feet on the correct set of pedals before you can operate your truck.

CHECK YOUR DISPLAY

If any truck function doesn't work, check the indicator lights on the console display.

! Know the Hazards

! DANGER

Falling from a raised platform can cause serious injury or even death.



Attach safety belt and tether when elevated and working with an open side gate.

FALLS CAN KILL

You can reduce the risk of injury by being extra careful while working on an elevated Turret Stockpicker.

- Put the side gates down and keep your entire body inside the operator area.
- Watch where you're going. Running into an object could cause you to fall.
- Wear your harness and keep your tether fastened when working with an open side gate.

Traverse, Extend & Pivot

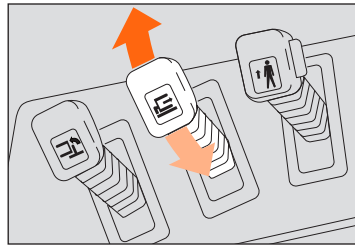
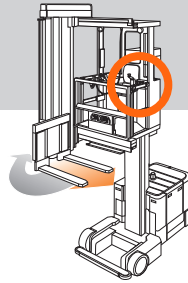

TRAVERSE & EXTEND/RETRACT

Move the Traverse, Extend/Retract handle toward you to move the forks and carriage to the right. Move the handle away from you to move the forks and carriage to the left.

The farther you move the handle the faster the carriage, or forks, will move.

Make sure the load will clear the platform.

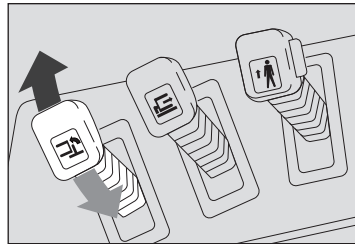

PIVOT

Move the Pivot handle toward you to pivot the forks counter clockwise. Move the handle away from you to pivot the forks clockwise.

The farther you move the handle the faster the forks will pivot.

Before you pivot a load, make certain it will not poke or intrude into the operator area.

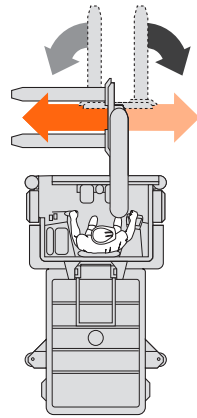

OVERRIDE SWITCHES

Traverse and Extend/Retract override switches are located under the right-hand console. Use these switches to get the forks out of the rack in case of electrical malfunction.

Traverse Override

Actuate the Traverse override switch while moving the Traverse & Extend/Retract handle.

Extend/Retract Override

Actuate both the Traverse and the Extend/Retract override switches while moving the Traverse & Extend/Retract handle.

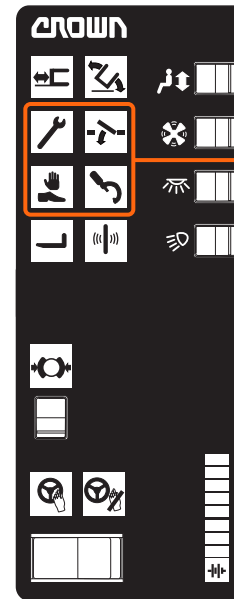

CHECK YOUR DISPLAY

If any hydraulic function doesn't work, check the indicator lights on the console display.

- The gates must be down.
- The palm interlock switch must be actuated.
- The proper set of foot interlock pedals must be actuated.
- Some service conditions may also prevent you from operating your truck.

Raise & Lower

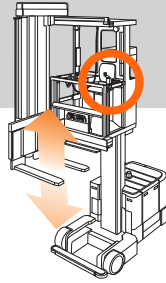

RAISE & LOWER

Primary raise and lower lets you move the entire operator platform, and forks, up or down on the primary mast.

Auxiliary raise and lower lets you move just the forks up or down on the auxiliary mast.

Note: Emergency manual lowering valve located behind power unit door.

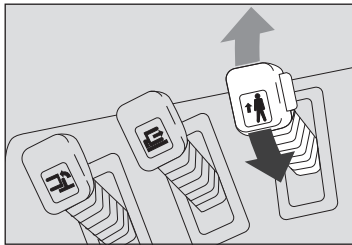

Primary Raise/Lower

Move the Raise/Lower handle toward you to raise the platform and forks. Move the handle away from you to lower the platform and the forks.

The farther you move the handle the faster the platform will raise or lower.

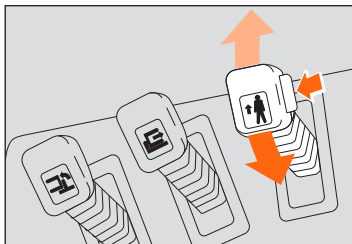
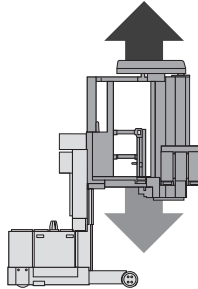

Auxiliary Raise/Lower

Press the button in the side of the handle and move the handle toward you to raise only the forks. Press the button and move the handle away from you to lower only the forks.

The farther you move the handle the faster the forks will raise or lower.

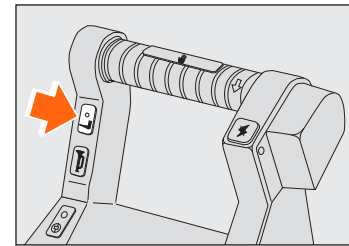
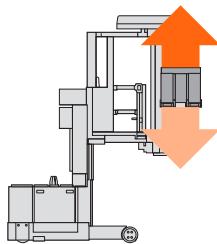

RAISE/LOWER CUTOUT (optional)

Your truck may be equipped with automatic cutout of raise and lower at selected heights.

If Raise or Lower stops and the red fork symbol on the display is lit, you are at a raise or lower cutout height.

To travel past the cutout height, push the Cutout Override button while, at the same time, moving the Raise/Lower handle.

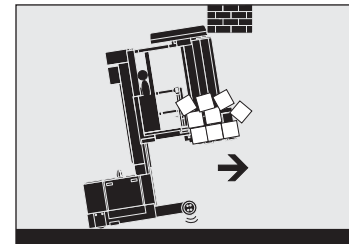

Be very careful and watch that you don't raise, lower or drive into obstructions when using the Cutout Override.

! Know the Hazards

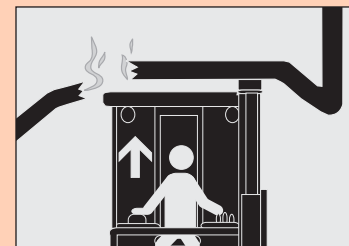

RAISE/LOWER CUTOUT OVERRIDE

Using the Cutout Override allows you to travel, or raise the platform, into areas where there are obstructions and hazards such as pipes, ducts, conduits, low ceilings etc.

Hitting any obstruction could tip the truck over, causing serious injury or even death.

Watch out for obstructions anytime you're operating your truck. Be even more careful when using Cutout Override.

Steering & Travel

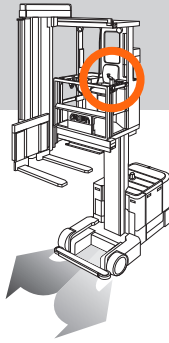

LIFT TRUCKS ARE NOT LIKE AUTOMOBILES

Your lift truck does not steer or drive like an automobile. Be sure you are trained to operate this truck. Even then, drive slowly until you get use to the steering and all other controls.

STEERING AND DRIVING

You will need to drive your truck both in the direction of the forks (forks first) and also away from the forks (power unit first or forks trailing). Steering is not the same in both directions.

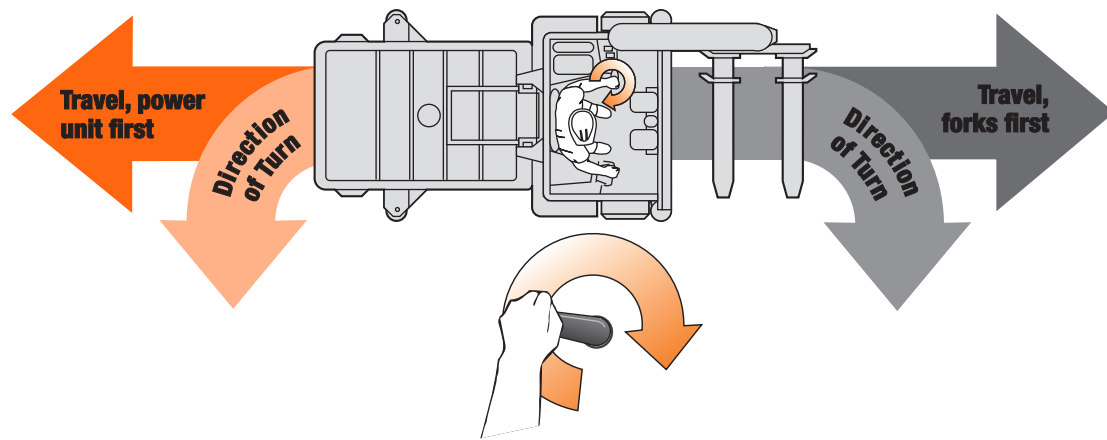

This shows the direction your truck will turn, when you turn the steering handle clockwise.

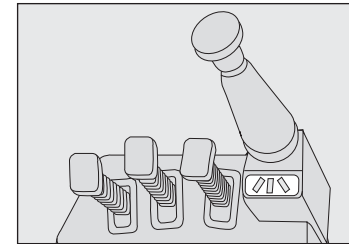

STEER/DRIVE WHEEL DIRECTION DISPLAY

The indicator lights show you whether the drive wheel is straight (within 5 degrees), or turned either right or left.

! Know the Hazards

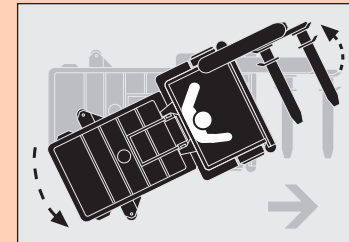

POWER UNIT SWING

Be careful turning while traveling forks first. The power unit will swing wide in the opposite direction. Make sure you have clearance, and watch out for people in the area.

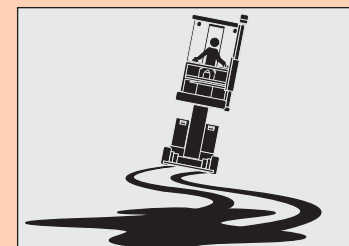

SLOW DOWN FOR SPILLS OR WET FLOORS

Powder or liquid spills can cause slippery floors. Slow down or you could lose control of steering and braking. Be careful and allow for a longer stopping distance.

Don't run over objects on the floor.

Traveling & Plugging

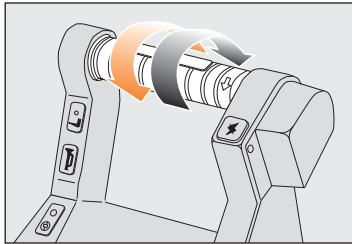
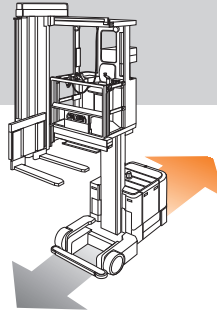

TRAVEL

Rotate the top of the twist grip in the direction you want to travel.

The farther you rotate the grip from the neutral position, the faster the truck will travel.

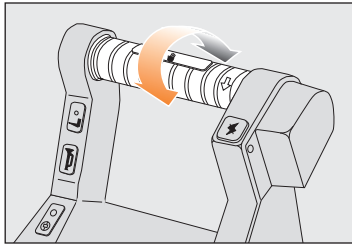

PLUGGING

Plugging is another way to slow down or stop your truck. While the truck is moving, in either direction, rotate the twist grip through neutral to the opposite direction of travel. Use the twist grip to control how quickly you slow down.

Plugging will not hurt your truck.

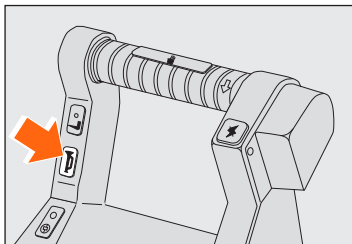

HORN

Press the horn button to blow the horn. Use it to warn pedestrians and other drivers.

Use your horn when you leave the aisle or come to an intersection or crosswalk.

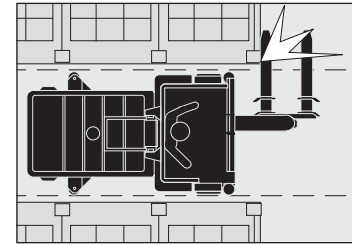

TRAVEL POSITION OF FORKS & CARRIAGE

Before traveling at full speed, you must pivot the forks and sideshift the carriage so they do not extend past the sides of the truck. The pivot and traverse indicators will light when the forks and carriage are properly positioned (see pages 15 & 16).

You must also make certain that the load does not extend past the sides of the truck.

CHECK YOUR DISPLAY

If your truck won't travel, or operates at a reduced speed, check the indicator lights on the console display.

! Know the Hazards

LOOK WHERE YOU'RE GOING

Travel in the direction where you have the best visibility.

PLUGGING VS. BRAKING

Of the two, the foot brakes are designed to stop the truck in the shortest distance. Use the foot brakes in an emergency, on ramps or in busy areas.

YOU CAN'T HAVE BOTH

Plugging works only when the brakes are off. When the brakes are applied, power is cut to the drive motors and you will not be able to plug.

Wire Guidance Option

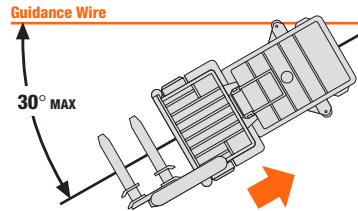
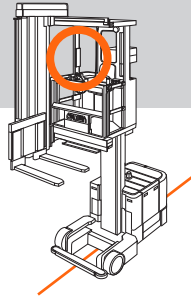

ACQUIRING THE WIRE

Push the wire guidance switch to ON as you near a guided aisle. Approach the wire at an angle of 30° or less. Drive slowly and center the truck over the wire. When you hear a "beep" and the red light turns off, begin guided driving. Start Slowly.

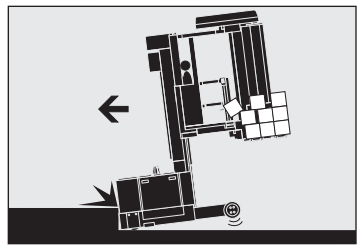

WHEN DRIVING ON THE WIRE

- Watch where you're going. Make sure your path is clear.
- Always be alert for "beeps" from the alarm or changes in the indicator lights that signal changes in guidance status.
- Start slowly after changing direction of travel. Be sure the truck is following the wire.

AUTOMATIC SLOW DOWN

While traveling on guidance, your truck may slow down automatically for certain conditions.

- Low signal strength from the wire.
- Truck deviates slightly from the wire.
- End of Aisle Control (optional) is activated.

AUTOMATIC STOP

Your truck may stop automatically for certain conditions.

- Signal strength from the wire is lost or is too low.
- Truck deviates too far from the wire.
- End of Aisle Control (optional) is activated.

FOR MANUAL STEERING

Take control of steering, push the guidance switch to OFF.

Note: Whenever guidance is OFF, the red light on the display will flash and the alarm will "beep", at a slow rate, to remind you that you are in manual steering.

When the truck senses a guidance wire, the rate of both the "beeping" and the flashing will speed up, to notify you that a wire is near. To acquire the wire, see page 31.

END OF AISLE CONTROL OPTION

With this feature, your truck will either slow down or stop automatically when it comes to the end of an aisle. You will hear a "beep", and the indicator light will turn on.

If the truck stops: let up on the accelerator, press the override button and resume travel.

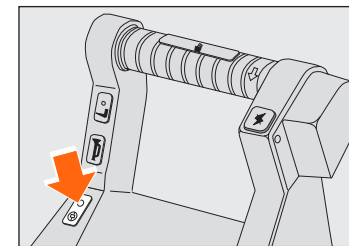

! Know the Hazards

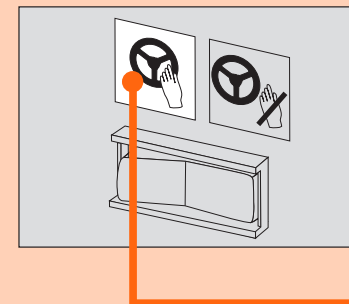

STAY ALERT

You must be just as careful and alert while driving on guidance as you are when driving with manual steering.

- Start slowly and look where you're going.
- Always be prepared to steer manually.
- Make sure there is nothing in your path, on the floor or sticking out of the racks.

LISTEN FOR THE "BEEP", CHECK THE DISPLAY

- Take control of the steering any time the red light is on.
- Check the display if you hear a "beep".

Daily Safety Check

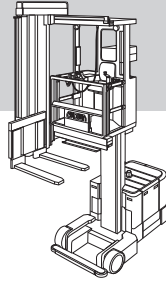

CHECK YOUR TRUCK BEFORE STARTING WORK

You must make sure your truck is safe to use.

1. Walk around your truck and check it over.

- Inspect your harness, tether, snap hooks and mounting points. Have them replaced if they look damaged or worn, or have ever been used to stop a fall.
- Clean the safety shields and keep them clear.
- Check to make sure the battery is charged, water level is OK and vent caps are in place. Don't use an open flame to check the battery.
- Make certain the battery retainer and side cover are properly installed.
- See that all wheels are in good condition.
- Make sure the flashing light is working.
- Check that both forks are secure and not bent, cracked or badly worn.
- Inspect all lift chains for damage.
- Look under the truck for signs of hydraulic leaks.
- Adjust the operator seat to the most comfortable position. Turn the rear view mirror to the best viewing position.
- Turn the key to TEST. See that the alarm and all indicator lights are working.
- Test the horn.
- Make sure the power disconnect works.

2. Test drive your truck in an uncongested area.

- Try all the hydraulic functions.
- Check that the steering is easy and smooth.
- Drive the truck slowly in both directions.
- Drive through the full speed range in both forward and reverse.
- Check braking and plugging distances in forward and reverse. Load size and floor conditions can affect these distances.
- Know the distance it takes to stop before you start working. If the braking distance is too long to stop safely, don't drive the truck.
- Check wire guidance operation.

If anything doesn't look or feel right, don't drive the truck. Report the problem.

You can get checklist forms from your Crown dealer (part no. OF-3772). Used properly, this checklist can alert service people to needed repairs.

Be a Safe Driver

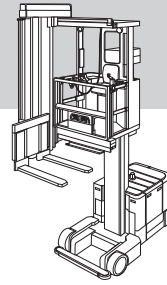

*The most
important
component
is you.*



MAKE SURE YOU ARE READY TO DRIVE

- Do not use this truck unless you are trained and certified.
- Be certain you understand how your truck works and the hazards that go with it. Don't drive the truck if you have any doubts.
- Know the capacity of your truck (Load Weight, Load Center and Lift Height). Make certain you use the correct units of measure.
- Some trucks are not allowed in areas where there are fire hazards. Be certain your truck is the correct fire safety type for the area.
- Make sure your hands and shoes are clean and dry, and your clothing is proper for the job.

MAKE SURE YOUR TRUCK IS READY

- Inspect your truck before using it (see pages 33 and 34). If it's not working right, or something is broken, report the problem. Don't use the truck.
- In an open area, test the braking and plugging. Check at a slow travel speed first, then a faster one. Know the distance it takes to stop before you start work.

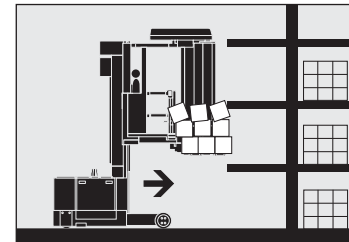
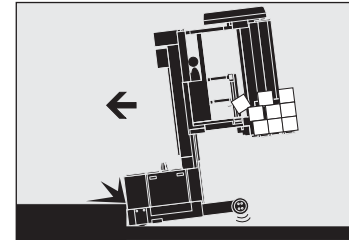

DRIVE CAUTIOUSLY, BE ALERT

- Wear your harness and have the tether fastened when elevated and working with an open side gate.
- Never stick an arm, foot or any part of your body outside the operator area, no matter how slow the truck is moving. A hand or foot caught between the truck and a fixed object will be crushed or even cut off.
- Keep your hands on the controls and feet on the pedals.
- Travel in the direction that gives you the best view. Look where you're going, slow down in congested areas.
- Slow down for slippery floors. Don't run over things.
- Travel with the platform close to the ground when outside of an aisle. Place the load against the vertical face of the forks.
- Be certain forks and load are in the travel position.
- Look where you are going before you change direction of travel. Slow down when making turns.
- See that you have room to drive and turn. Check for overhead objects. Watch out for power unit and fork (load) swing.
- Make certain the load will clear the operator platform before you use Traverse, Extend/Retract or Pivot.
- Avoid sudden movement of controls. Learn to use them smoothly at a moderate, even rate.
- Check clearances before raising or lowering the forks or load. Watch for overhead obstructions.
- Be extra careful if you must use your truck in an area where there is a risk of falling objects.

Continued next page...

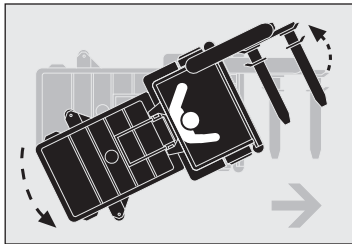
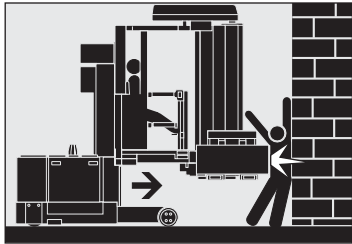
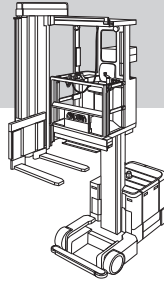

WATCH OUT FOR OTHER PEOPLE

- Slow down. Yield or stop for pedestrians. Use your horn when you come to a crosswalk or intersection.
- Be careful that you don't pin or crush someone. *For example: Never drive your truck toward anyone standing in front of a fixed object.*
- Watch out for power unit and fork (load) swing when turning.
- Never allow passengers on your truck.
- Keep others away from your truck while you're working. Don't ever allow anyone on or under the load or forks.
- Don't let anyone use your truck unless they are trained and certified.
- Never lift anyone with the forks unless they are using an approved platform. Even then use extreme caution:
 - Use a securely attached and approved safety platform.
 - Make certain lifting mechanism is operating properly.
 - Make certain truck is in neutral and brake is applied.
 - Lift and lower slowly.
 - Watch for overhead obstructions.
 - Be sure you can see and hear the person being lifted.
 - Never transport anyone on a safety platform from one location to another.

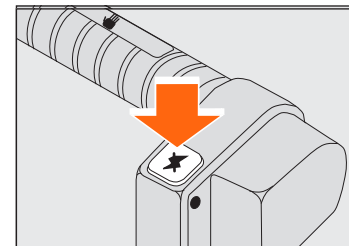
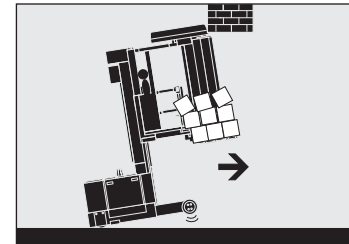
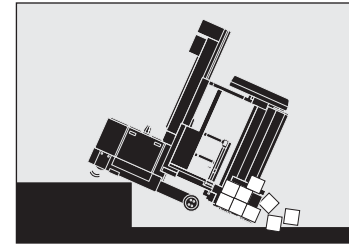

AVOID FALLS AND TIPOVERS

- Be extremely careful when working around docks or ramps. Stay away from the edge.
- Check capacities. Be sure your truck, with load, isn't too heavy for where you are driving.
- Make sure the load you are moving is stable. Spread the forks as far as you can and center the load. Insert the forks as far under the load as you can.
- Watch out for overhead obstructions.
- Turret trucks should not be used on ramps or grades. If you must drive on a grade, travel slowly and never turn the truck. If carrying a load, travel with forks upgrade. If unloaded, travel with forks downgrade. Keep the fork height below 300mm (12 inches).

LEAVING YOUR TRUCK

- Stop your truck completely before getting off.
- Lower the forks to the floor. Turn the truck off or disconnect the battery.
- Avoid parking on inclines. But if you must, block the wheels of your truck.

Battery Maintenance

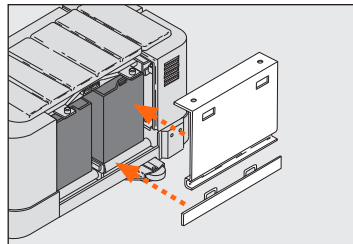
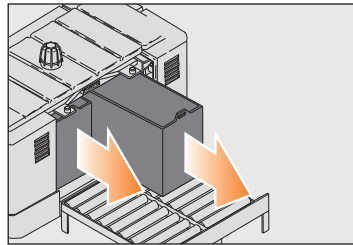
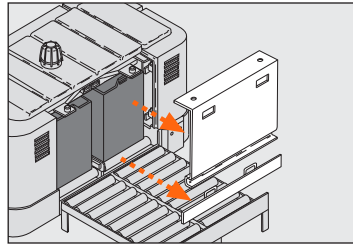
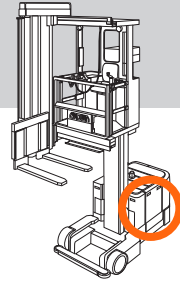

WHEN YOU INSTALL OR CHANGE BATTERIES

- Turn the truck OFF. Make sure the parking brake is applied and all other controls are in neutral. Disconnect the batteries.
- Make certain you use the correct size and weight batteries. Never operate a truck that has underweight or undersized batteries installed.
- Use a roller stand to install or remove batteries. Make sure the roller stand is the same height as the rollers in the truck's battery compartment. Also be certain the roller stand is at least as long as your batteries.
- Never let anything metal touch the top of the cells. You could cause sparks or do damage to the batteries. Use an insulator (such as plywood) when necessary.
- Use an approved spreader bar to place the batteries on, or remove them from a stand. Make sure you adjust the spreader bar hooks to fit the batteries.

AFTER INSTALLING BATTERIES

- Replace the battery retainer and side cover.
- Connect the batteries. Turn the truck ON and check truck operation.

! Know the Hazards

! DANGER



Batteries produce explosive gas. Do not smoke, use open flame, or create an arc or sparks near this battery. Ventilate well in enclosed areas and when charging.

Batteries contain **Sulfuric Acid** which causes severe burns. Do not get in eyes, on skin, or clothing. In case of contact, flush immediately. Get medical attention if your eyes are affected.

107

TRUCK BATTERIES CAN BE DANGEROUS

Your truck batteries produce fumes that can explode. They also contain acid that could burn or disfigure you.

- Do not try to install, remove, charge or service your truck batteries unless you are trained and authorized.
- Never smoke or use an open flame around batteries.
- Your company should provide an area where it is safe to work on batteries. Use that area for all battery work.
- Use protective equipment such as gloves, eye shields, aprons etc.

BATTERY RETAINER

The batteries could slide out if the retainer is not in place. Check before you operate your truck.

! WARNING

Minimum battery size allowed

XXX mm (XX.XX in.) wide
XXX mm (XX.XX in.) long

Undersize battery can affect truck handling and stability. You could have an accident.

Use U.L. classified Type EO battery.

BATTERY SIZE

Make certain you use the correct size and weight batteries. Never operate a truck that has underweight or undersized batteries installed.

Continued next page...

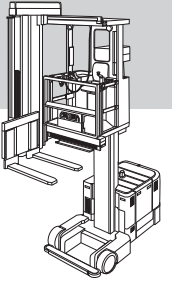

EACH WARNING LABEL ON YOUR TRUCK IS IMPORTANT

Read and obey all of them to protect yourself and others.

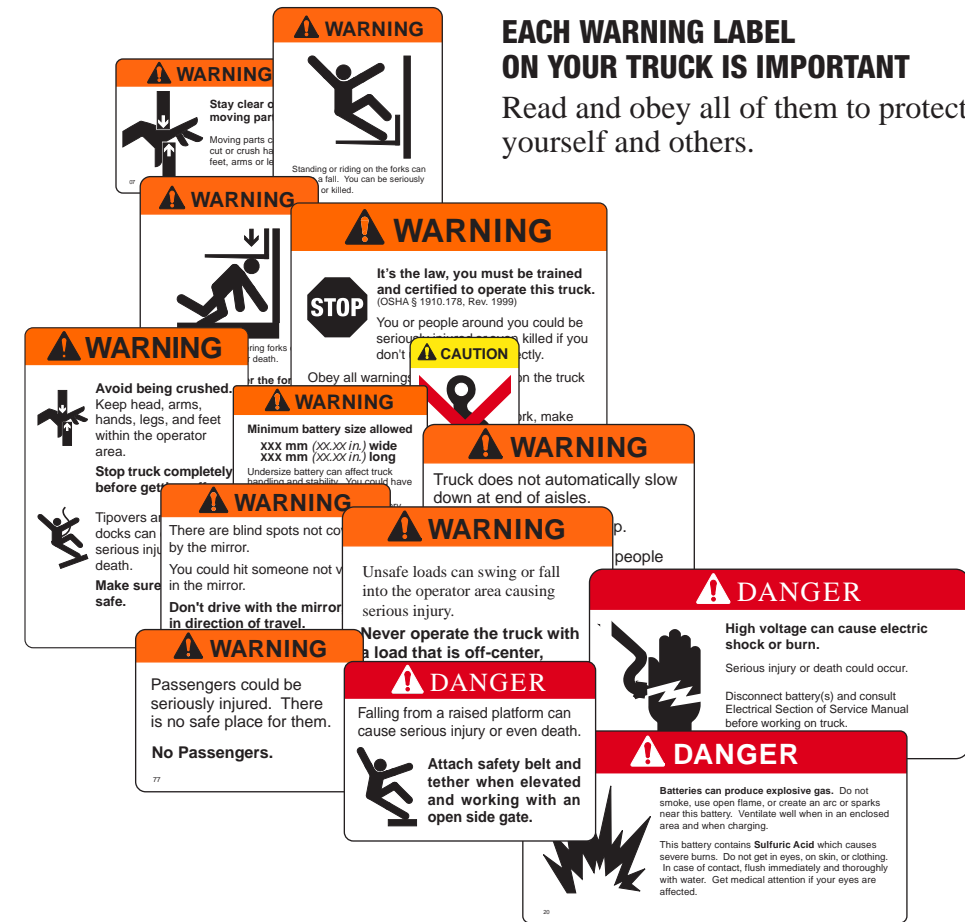

Know the Hazards



BEFORE CHARGING YOUR TRUCK BATTERIES

- Charge the batteries in designated areas only.
- See that the battery cells are filled to the proper level. Never use an open flame to check the batteries.
- Make certain the chargers are the same voltage and amperage as your batteries.
- Read the battery charger instructions.
- Be sure chargers are turned off before connecting batteries to them. Otherwise you might create a spark which could cause a battery to explode. Also, make sure the truck key switch is turned off and all controls are in the neutral position.

All rights reserved under International and Pan American copyright conventions
Copyright 1997 Crown Equipment Corp.